

# EPSON

6-Axis Robots

## *N2 series*

MANIPULATOR MANUAL

Rev.7

EM198R4078F



6-Axis Robots

# *N2 series Manipulator Manual*

Rev. 7

Copyright © 2016-2019 SEIKO EPSON CORPORATION. All rights reserved.

## FOREWORD

Thank you for purchasing our robot products.

This manual contains the information necessary for the correct use of the manipulator.

Please carefully read this manual and other related manuals before installing the robot system.

Keep this manual handy for easy access at all times.

## WARRANTY

The robot and its optional parts are shipped to our customers only after being subjected to the strictest quality controls, tests, and inspections to certify its compliance with our high performance standards.

Product malfunctions resulting from normal handling or operation will be repaired free of charge during the normal warranty period. (Please ask your Regional Sales Office for warranty period information.)

However, customers will be charged for repairs in the following cases (even if they occur during the warranty period):

1. Damage or malfunction caused by improper use which is not described in the manual, or careless use.
2. Malfunctions caused by customers' unauthorized disassembly.
3. Damage due to improper adjustments or unauthorized repair attempts.
4. Damage caused by natural disasters such as earthquake, flood, etc.

Warnings, Cautions, Usage:

1. If the robot or associated equipment is used outside of the usage conditions and product specifications described in the manuals, this warranty is void.
2. If you do not follow the WARNINGS and CAUTIONS in this manual, we cannot be responsible for any malfunction or accident, even if the result is injury or death.
3. We cannot foresee all possible dangers and consequences. Therefore, this manual cannot warn the user of all possible hazards.

## TRADEMARKS

Microsoft, Windows, and Windows logo are either registered trademarks or trademarks of Microsoft Corporation in the United States and/or other countries. Other brand and product names are trademarks or registered trademarks of the respective holders.

## NOTICE

No part of this manual may be copied or reproduced without authorization.

The contents of this manual are subject to change without notice.

Please notify us if you should find any errors in this manual or if you have any comments regarding its contents.

## MANUFACTURER

**SEIKO EPSON CORPORATION**

## CONTACT INFORMATION

Contact information is described in “SUPPLIERS” in the first pages of the following manual:

*Robot System Safety and Installation Read this manual first*

## Regarding battery disposal



The crossed out wheeled bin label that can be found on your product indicates that this product and incorporated batteries should not be disposed of via the normal household waste stream. To prevent possible harm to the environment or human health please separate this product and its batteries from other waste streams to ensure that it can be recycled in an environmentally sound manner. For more details on available collection facilities please contact your local government office or the retailer where you purchased this product. Use of the chemical symbols Pb, Cd or Hg indicates if these metals are used in the battery.

This information only applies to customers in the European Union, according to DIRECTIVE 2006/66/EC OF THE EUROPEAN PARLIAMENT AND OF THE COUNCIL OF 6 September 2006 on batteries and accumulators and waste batteries and accumulators and repealing Directive 91/157/EEC and legislation transposing and implementing it into the various national legal systems.

For other countries, please contact your local government to investigate the possibility of recycling your product.

The battery removal/replacement procedure is described in the following manuals:

Controller manual / Manipulator manual (Maintenance section)

# Before Reading This Manual

This section describes what you should know before reading this manual.

## Structure of Control System

N2 Manipulators can be used with the following combinations of Controllers and software.

Controller : RC700

Software : EPSON RC+ 7.0 Ver.7.2.1 or later

## Setting by Software

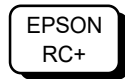

This manual contains setup procedures using the software.

Those sections are indicated by the symbol on the left.

## Turning ON/OFF Controller

When you see the instruction “Turn ON/OFF the Controller” in this manual, be sure to turn ON/OFF all the hardware components.

## Photos and Illustrations Used in This Manual

The appearance of some parts may differ from those on an actual product depending on when it was shipped or the specifications. The procedures themselves, however, are accurate.





## Setup & Operation

<b>1. Safety</b>	<b>3</b>
1.1 Conventions.....	3
1.2 Design and Installation Safety.....	3
1.3 Operation Safety .....	4
1.4 Emergency Stop.....	6
1.5 How to Move Arms with the Solenoid Brake.....	8
1.6 Precaution for Operation in Low Power Status.....	10
1.7 Warning Labels.....	11
<b>2. Specifications</b>	<b>14</b>
2.1 Features of Manipulators .....	14
2.2 Model Number.....	14
2.3 Part Names.....	15
2.4 Outer Dimensions.....	16
2.4.1 S/N: N201000001~N201010000 .....	16
2.4.2 S/N: N201010001 or later.....	17
2.5 Standard Motion Range .....	18
2.6 Specifications .....	19
2.6.1 Specifications table .....	19
2.6.2 Option .....	21
2.7 How to Set the Model.....	22
<b>3. Environment and Installation</b>	<b>23</b>
3.1 Environmental Conditions .....	23
3.2 Unpacking, Transportation, and Relocation.....	24
3.3 Mounting Dimensions.....	26
3.4 Installation .....	27
3.5 Base Table.....	29
3.6 Connecting the Cables.....	31
3.7 User Wires and Pneumatic Tubes.....	32
3.8 Checking the Basic Orientation.....	34
<b>4. End Effectors</b>	<b>35</b>
4.1 Attaching an End Effector.....	35
4.2 Attaching Camera and Air Valves.....	36
4.3 WEIGHT and INERTIA Settings.....	37
4.3.1 WEIGHT setting.....	38
4.3.2 INERTIA setting .....	41
4.4 Precautions for Auto Acceleration/Deceleration.....	45

<b>5. Motion Range</b>	<b>46</b>
5.1 Motion Range Setting by Pulse Range (for Each Joint)	46
5.1.1 Max. Pulse Range of Joint #1	47
5.1.2 Max. Pulse Range of Joint #2	47
5.1.3 Max. Pulse Range of Joint #3	48
5.1.4 Max. Pulse Range of Joint #4	48
5.1.5 Max. Pulse Range of Joint #5	49
5.1.6 Max. Pulse Range of Joint #6	49
5.2 Restriction of Manipulator Operation	50
5.3 Coordinate System	52
5.4 Changing the Robot	53
5.5 Setting the Cartesian (Rectangular) Range in the XY Coordinate System of the Manipulator	55
<b>6. Options</b>	<b>56</b>
6.1 Brake Release Unit	56
6.2 Camera Plate Unit	60
6.3 Tool Adapter (ISO Flange)	62
6.4 User Wires	63
6.5 Wiring Guide	64
6.6 Table Top Mount Bracket	65
6.7 Calibration Plate	67

## Maintenance

<b>1. Safety Maintenance</b>	<b>71</b>
<b>2. General Maintenance</b>	<b>73</b>
2.1 Maintenance Inspection	73
2.1.1 Schedule for Maintenance Inspection	73
2.1.2 Inspection Point	74
2.2 Overhaul (Parts Replacement)	76
2.3 Greasing	78
2.4 Tightening Hexagon Socket Head Bolts	79
2.5 Layout of Maintenance Parts	80
<b>3. Covers</b>	<b>81</b>
3.1 Arm #1 Outside Cover	83
3.2 Joint #1 Cover	85
3.3 Arm #1 Inside Cover, Joint #2 Cover	86
3.4 Joint #2 Outside Cover	87
3.5 Arm #2 Outside Cover	88
3.6 Joint #3 Cover	89
3.7 Arm #2 Inside Cover	90
3.8 Arm #3 Upper Cover	91
3.9 Arm #3 Outside Cover	92
3.10 Arm #3 Side Cover, Arm #3 Upper Side Cover	93

---

3.11	Arm #4 Right Side Cover.....	95
3.12	Arm #4 Left Side Cover.....	96
3.13	Arm #5 Side Cover.....	97
3.14	Arm #5 Upper Cover.....	98
3.15	Base Cover.....	99
3.16	Connector Plate.....	100
<b>4. Cable Unit and FPC Unit</b>		<b>101</b>
4.1	Replacing the Cable Unit.....	101
4.2	Replacing the Relay Cables.....	131
4.2.1	HP_Harness_A_01.....	134
4.2.2	HP_Harness_A_02.....	135
4.2.3	HP_Harness_A_03.....	138
4.2.4	HP_Harness_A_04.....	139
4.2.5	HP_Harness_A_05.....	140
4.2.6	HP_Harness_A_06.....	141
4.2.7	HP_Harness_A_07.....	142
4.3	Replacing the FPC Unit.....	143
4.4	Replacing the M/C Cable.....	152
4.5	Connector Pin Assignment.....	155
4.5.1	Signal Cable.....	155
4.5.2	Power Cable.....	156
4.5.3	User Cable.....	157
4.5.4	Color of Cables.....	158
<b>5. Actuator Units</b>		<b>159</b>
5.1	Replacing the Joint #1 Actuator Unit.....	161
5.2	Replacing the Joint #2 Actuator Unit.....	170
5.3	Replacing the Joint #3 Actuator Unit.....	176
5.4	Replacing the Joint #4 Actuator Unit.....	183
5.5	Joint #5.....	189
5.5.1	Replacing the Motor Unit.....	189
5.5.2	Replacing the Reduction Gear Unit.....	194
5.5.3	Replacing the Timing Belt.....	202
5.6	Replacing the Joint #5, #6 Actuator Unit.....	204
5.7	Replacing the Joint #6 Actuator Unit.....	207
<b>6. Battery</b>		<b>209</b>
6.1	Replacing the Battery Unit (Lithium Metal Battery).....	211
6.2	Replacing the Battery Board.....	212

<b>7. Boards</b>	<b>214</b>
7.1 Replacing the Control Board 1.....	216
7.2 Replacing the Control Board 2.....	217
7.3 Replacing the Encoder Board 1.....	218
7.4 Replacing the Encoder Board 2.....	221
7.5 Replacing the Encoder Board 3.....	222
7.6 Replacing the Encoder Board 4.....	224
7.7 Replacing the Filter Board.....	225
7.8 Replacing the Brake Board.....	227
7.9 Replacing the FPC board 1.....	229
7.10 Replacing the FPC Board 2.....	231
7.11 Replacing the LED Board.....	233
<b>8. Calibration</b>	<b>235</b>
8.1. Overview.....	235
8.2. Calibration Procedure.....	238
<b>9. Maintenance Parts List</b>	<b>247</b>
<b>10. Option Parts List</b>	<b>250</b>

# Setup & Operation

This volume contains information for setup and operation of the Manipulators.

Please read this volume thoroughly before setting up and operating the Manipulators.



# 1. Safety



Installation and transportation of the Manipulators and robotic equipment shall be performed by qualified personnel and should conform to all national and local codes.

Please read this manual and other related manuals before installing the robot system or before connecting cables.

Keep this manual handy for easy access at all times.

## 1.1 Conventions

Important safety considerations are indicated throughout the manual by the following symbols. Be sure to read the descriptions shown with each symbol.

 WARNING	This symbol indicates that a danger of possible serious injury or death exists if the associated instructions are not followed properly.
 WARNING	This symbol indicates that a danger of possible harm to people caused by electric shock exists if the associated instructions are not followed properly.
 CAUTION	This symbol indicates that a danger of possible harm to people or physical damage to equipment and facilities exists if the associated instructions are not followed properly.

## 1.2 Design and Installation Safety

Only trained personnel should design and install the robot system. Trained personnel are defined as those who have taken robot system training and maintenance training classes held by the manufacturer, dealers, or local representative companies, or those who understand the manuals thoroughly and have the same knowledge and skill level as those who have completed the training courses.

To ensure safety, a safeguard must be installed for the robot system. For details on the safeguard, refer to the *Installation and Design Precautions* in the *Safety* chapter of the EPSON RC+ User's Guide.

The following items are safety precautions for design personnel:

 WARNING	<ul style="list-style-type: none"> <li>■ Personnel who design and/or construct the robot system with this product must read the <i>Safety</i> chapter in the EPSON RC+ User's Guide. Designing and/or constructing the robot system without understanding the safety requirements is extremely hazardous, and may result in serious bodily injury and/or severe equipment damage to the robot system.</li> </ul>
--	--

 WARNING	<ul style="list-style-type: none"> <li>■ The Manipulator and the Controller must be used within the environmental conditions described in their respective manuals. This product has been designed and manufactured strictly for use in a normal indoor environment. Using the product in an environment that exceeds the specified environmental conditions may not only shorten the life of the product but may also cause serious safety problems.</li> <li>■ The robot system must be used within the installation requirements described in the manuals. Using the robot system outside of the installation requirements may not only shorten the life of the product but also cause serious safety problems.</li> </ul>
--	---

Further precautions for installation are described in the chapter *Setup & Operation 3. Environment and Installation*. Please read this chapter carefully to understand safe installation procedures before installing the robots and robotic equipment.



### 1.3 Operation Safety

The following items are safety precautions for qualified Operator personnel:

 WARNING	<ul style="list-style-type: none"> <li>■ Please carefully read the <i>Safety-related Requirements</i> in the <i>Safety</i> chapter of the <i>Safety and Installation</i> manual. Operating the robot system without understanding the safety requirements is extremely hazardous and may result in serious bodily injury and/or severe equipment damage to the robot system.</li> <li>■ Do not enter the operating area of the Manipulator while the power to the robot system is turned ON. Entering the operating area with the power ON is extremely hazardous and may cause serious safety problems as the Manipulator may move even if it seems to be stopped.</li> <li>■ Before operating the robot system, make sure that no one is inside the safeguarded area. The robot system can be operated in the mode for teaching even when someone is inside the safeguarded area. The motion of the Manipulator is always in restricted status (low speeds and low power) to secure the safety of an operator. However, operating the robot system while someone is inside the safeguarded area is extremely hazardous and may result in serious safety problems in case that the Manipulator moves unexpectedly.</li> <li>■ Immediately press the Emergency Stop switch whenever the Manipulator moves abnormally during operation. Continuing the operation while the Manipulator moves abnormally is extremely hazardous and may result in serious bodily injury and/or severe equipment change to the robot system.</li> </ul>
--	--

 WARNING	<ul style="list-style-type: none"> <li>■ Be sure to connect the AC power cable to a power receptacle. <b>DO NOT</b> connect it directly to a factory power source. To shut off power to the robot system, disconnect the power plug from the power source. Performing any work while connecting the AC power cable to a factory power source is extremely hazardous and may result in electric shock and/or malfunction of the robot system.</li> </ul>
--	---



 <p>WARNING</p>	<ul style="list-style-type: none"><li>■ Before performing any replacement procedure, turn OFF the Controller and related equipment, and then disconnect the power plug from the power source. Performing any replacement procedure with the power ON is extremely hazardous and may result in electric shock and/or malfunction of the robot system.</li><li>■ Do not connect or disconnect the motor connectors while the power to the robot system is turned ON. Connecting or disconnecting the motor connectors with the power ON is extremely hazardous and may result in serious bodily injury as the Manipulator may move abnormally, and also may result in electric shock and/or malfunction of the robot system.</li></ul>
 <p>CAUTION</p>	<ul style="list-style-type: none"><li>■ Whenever possible, only one person should operate the robot system. If it is necessary to operate the robot system with more than one person, ensure that all people involved communicate with each other as to what they are doing and take all necessary safety precautions.</li><li>■ If the joints are operated repeatedly with the operating angle less than 5 degrees, they may get damaged early because the bearings are likely to cause oil film shortage in such situation. To prevent early breakdown, move the joints larger than 30 degrees for about five to ten times a day.</li><li>■ Oscillation (resonance) may occur continuously in low speed Manipulator motion (Speed: approx. 5 to 20%) depending on combination of Arm orientation and end effector load. Oscillation arises from natural oscillation frequency of the Arm and can be controlled by following measures.<ul style="list-style-type: none"><li>Changing Manipulator speed</li><li>Changing the teach points</li><li>Changing the end effector load</li></ul></li></ul>

## 1.4 Emergency Stop

If the Manipulator moves abnormally during operation, immediately press the Emergency Stop switch. Pressing the Emergency Stop switch immediately changes the Manipulator to deceleration motion and stops it at the maximum deceleration speed.

However, avoid pressing the Emergency Stop switch unnecessarily while the Manipulator is running normally. Otherwise, the Manipulator may hit the peripheral equipment since the operating trajectory until the robot system stops is different from that in normal operation.

Do not press the Emergency Stop switch unnecessarily while the Manipulator is operating. Pressing the switch during operation makes the brakes work. This will shorten the life of the brakes due to the worn friction plates.

Normal brake life cycle: About 2 years (when the brakes are used 100 times/day)

Also, the Emergency Stop during operation applies impact on the reduction gear unit, and it may result in the short life of the reduction gear unit.

To place the robot system in emergency mode during normal operation, press the Emergency Stop switch while the Manipulator is not moving.

Refer to the Controller manual for instructions on how to wire the Emergency Stop switch circuit.

Do not turn OFF the Controller while the Manipulator is operating.

If you attempt to stop the Manipulator in emergency situations, make sure to stop the Manipulator using the Emergency Stop switch of the Controller.

If the Manipulator is stopped by turning OFF the Controller while it is operating, the following problems may occur.

Reduction of the life and damage of the reduction gear unit

Position gap at the joints

In addition, if the Controller was forced to be turned OFF by blackouts and the like while the Manipulator is operating, make sure to check the following points after power restoration.

Whether or not the reduction gear is damaged

Whether or not the joints are in their proper positions

If there is a position gap, perform calibration by referring to the *Maintenance 8. Calibration* in this manual.

Before using the Emergency Stop switch, be aware of the followings.

- The Emergency Stop (E-STOP) switch should be used to stop the Manipulator only in case of emergencies.
- To stop the Manipulator operating the program except in emergency, use Pause (halt) or STOP (program stop) commands.  
Pause and STOP commands do not turn OFF the motors. Therefore, the brake does not function.
- For the Safeguard system, do not use the circuit for E-STOP.

For details of the Safeguard system, refer to the following manuals.

*EPSON RC+ User's Guide 2. Safety - Installation and Design Precautions  
- Safeguard System*

*Safety and Installation 2.6 Connection to EMERGENCY Connector*

To check brake problems, refer to the following manuals.

*Manipulator Manual Maintenance 2.1.2 Inspection Point*

*- Inspection While the Power is ON  
(Manipulator is operating)*

*Safety and Installation*

*5.1.1 Manipulator*

*- Inspection While the Power is ON  
(Manipulator is operating)*

### Free running distance in emergency

The Manipulator in operation cannot stop immediately after the Emergency Stop switch is pressed. However, time, angle, and distance of the free running vary by following factors:

Hand weight      WEIGHT Setting      ACCEL Setting  
Workpiece weight      SPEED Setting      Posture etc.

Approximate time and distance of the free running are as follow:

#### Conditions of Measurement

	N2 series
ACCEL Setting	100
SPEED Setting	100
Load [kg]	2.5
WEIGHT Setting	2.5

Robot Controller		RC700-A
Manipulator		N2-A450S*
Free running time [sec.]	Arm #1	0.75
	Arm #2	0.7
	Arm #3	0.5
	Arm #4	0.35
	Arm #5	0.35
	Arm #6	0.3
Free running angle [°]	Arm #1	55
	Arm #2	65
	Arm #3	70
	Arm #4	20
	Arm #5	20
	Arm #6	40

## 1.5 How to Move Arms with the Solenoid Brake

There are two methods to release the Solenoid brake.

Follow either method to release the Solenoid brake and move the arm manually.

The Joint #1 is not equipped with the Solenoid brake.

**Moving the arm using the brake release unit:**

Follow the method when you just unpack the delivered boxes or when the Controller does not start up yet.

The brake release unit is available as an option.

For details, refer to *Setup & Operation 6. Options*.

**Moving the arm using the software:**

Follow the method when you can use the software.



CAUTION

- Normally, release the brake of joints one by one. Take extra care if you need to release the brakes of two or more joints simultaneously. Releasing the brakes of two or more joints simultaneously may cause hands and fingers to be caught and/or equipment damage to or malfunction of the Manipulator as the arms of the Manipulator may move in unexpected directions.
- Be careful of the arm falling when releasing the brake. While the brake is being released, the Manipulator's arm falls by its own weight. The arm falling may cause hands and fingers to be caught and/or may cause equipment damage to or malfunction of the Manipulator.
- Before releasing the brake, be sure to keep the Emergency Stop switch handy so that you can immediately press the Emergency Stop switch. Otherwise, you cannot immediately stop the arm falling due to an erroneous operation. The arm falling may cause equipment damage to and/or malfunction of the Manipulator.

EPSON  
RC+

After releasing the Emergency Stop switch, execute the following command in [Command Window].

```
>Reset
```

```
>Brake Off, [the number (from 2 to 6) corresponding to the arm whose brake will be turned OFF]
```

Execute the following command to turn ON the brake again.

```
>Brake On, [The number (from 2 to 6) corresponding to the arm whose brake will be turned ON]
```

While the Solenoid brakes are ON (such as in emergency mode), you cannot move any arms except for Arm #1 by pushing manually.

Arm Motion

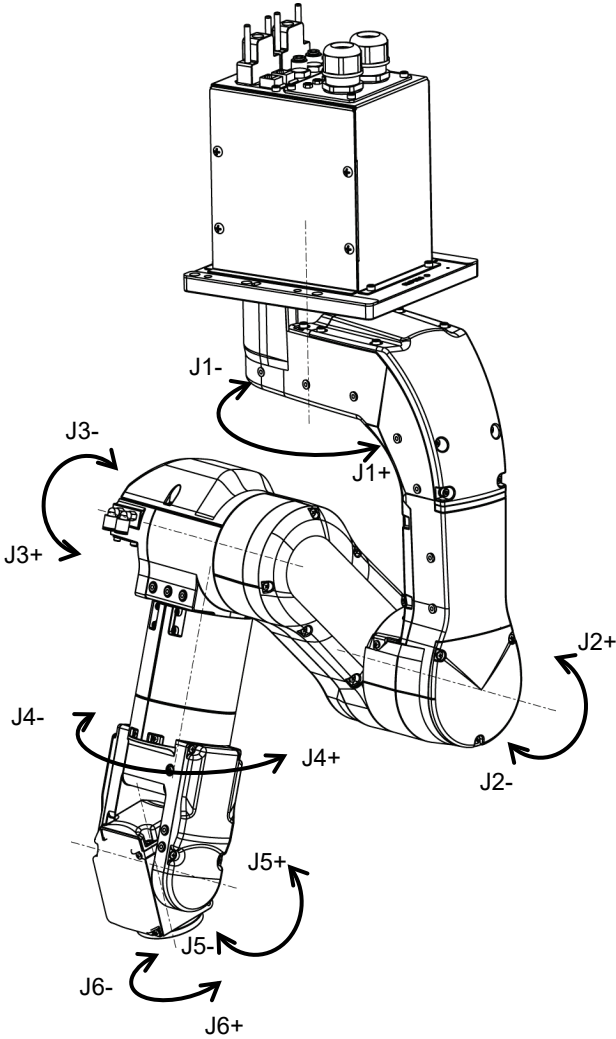

## 1.6 Precaution for Operation in Low Power Status

In the low power status, the Manipulator operates at low speed and low torque. However, comparatively high torque as shown in the table below may be generated to support the Manipulator's own weight.

Carefully operate the Manipulator since it may get your hands or fingers caught during operation. The Manipulator may also collide with peripheral equipment and cause equipment damage to or malfunction of the Manipulator.

Maximum Joint Torque in Low Power Status

[Unit: N·m]

Joint	#1	#2	#3	#4	#5	#6
Joint Torque	34.49	69.74	40.94	11.69	10.27	4.13



CAUTION

- Carefully operate the Manipulator in the low power status. A comparatively high joint torque may be generated. It may cause your hands and fingers caught and/or cause equipment damage to or malfunction of the Manipulator as it may collide with peripheral equipment.





## 1.7 Warning Labels

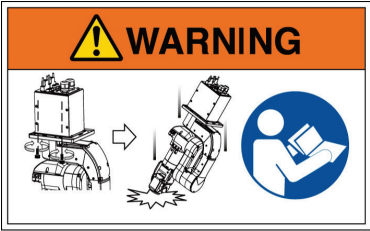
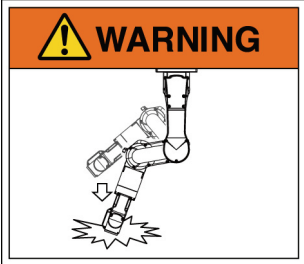

The Manipulator has the following warning labels.

The warning labels are attached around the locations where specific dangers exist.

Be sure to comply with descriptions and warnings on the labels to operate and maintain the Manipulator safely.

Do not tear, damage, or remove the warning labels. Use meticulous care when handling those parts or units to which the following warning labels are attached as well as the nearby areas.

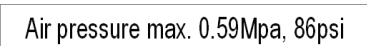
Location	Warning Label	NOTE
A		To avoid the Manipulator from falling, support the Manipulator before removing the base mounting screws. Follow the instructions in this manual for transportation and installation.
B		When releasing the brakes, be careful of the arm falling due to its own weight. This warning label is attached on the Manipulator and optional brake release unit.
C		You may get your hand or fingers caught when bringing your hand close to moving parts.
D		Do not enter the work space when the Manipulator is operating. It is extremely hazardous since the Arm may collide and cause serious safety problems.
E		Do not touch the current-carrying parts inside the Manipulator while the power is ON. It may cause electrical shock.
F		HOT Be careful not to burn yourself.

Location	Label	NOTE
G		Manipulator model, serial number, year and month of manufacture, weight, and maximum payload are printed.
H		Maximum air pressure is printed.
I		CE label

Location of Labels: S/N: N20100001~N20101000

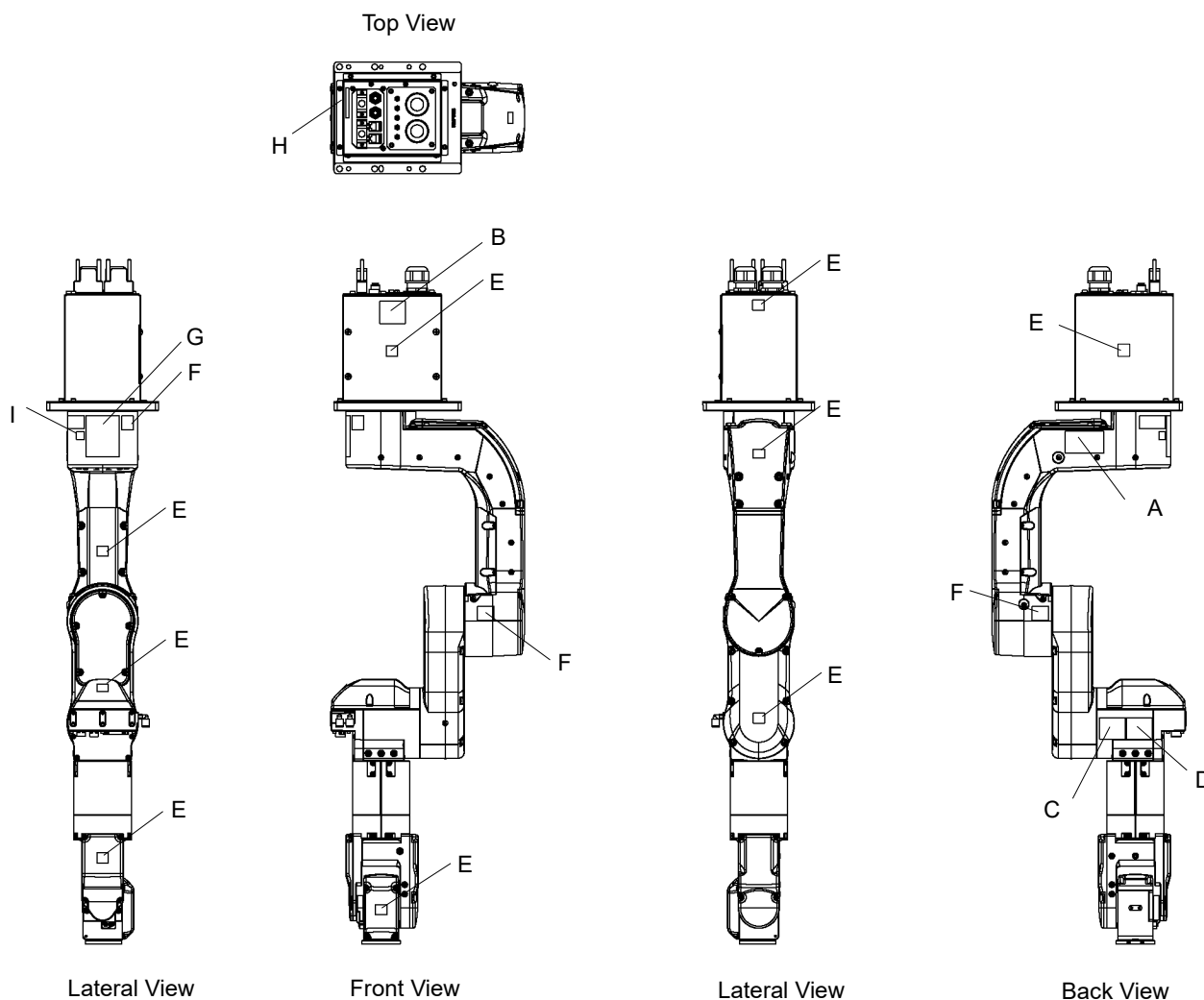



Location of Labels: S/N: N201010001 or later

Top View

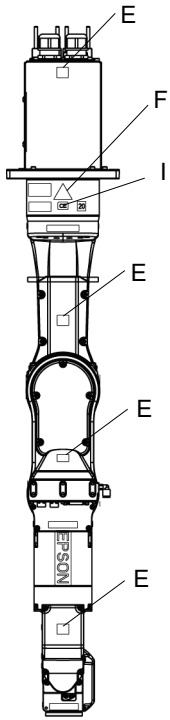
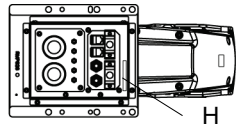

Lateral View

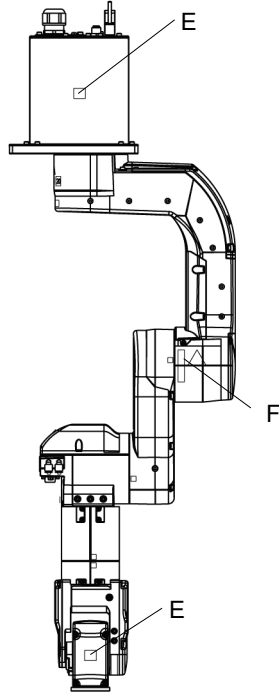

Front View

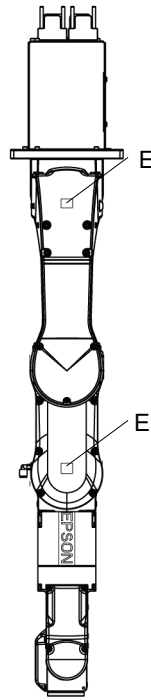

Lateral View

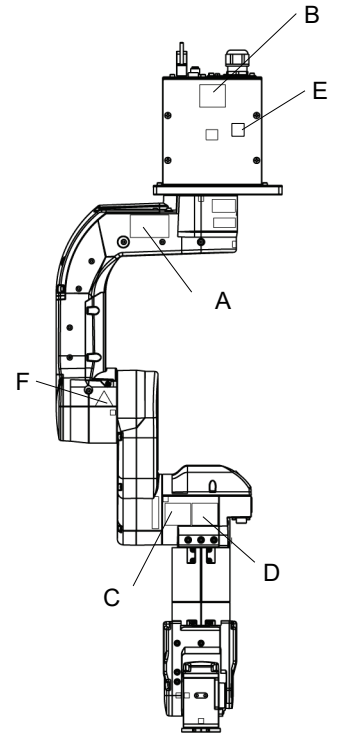

Back View

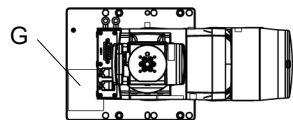

Bottom View

## 2. Specifications

### 2.1 Features of Manipulators

#### Speed & Accuracy

The Manipulator can convey the work pieces quickly in a shortest distance with shortcut motion.

The repeatability of  $\pm 20 \mu\text{m}$  is available.

#### Space Saving

The Manipulator can be installed in a  $\square 600 \text{ mm}$  working space which is equivalent to the space for human worker.

Due to the non-projecting arm structure of the Joint #3, motion for avoiding interference with peripherals can be reduced.

#### High Operability

Despite it being a 6-axis robot, the Manipulator can provide operability similar to the SCARA robots with its foldable elbow structure.

#### Skillful Wrist

Compact wrist (Joint #5) with wide motion range enables smooth movement and the ability to work from many angles

Minimal interference with surroundings improves flexibility in hand design

### 2.2 Model Number

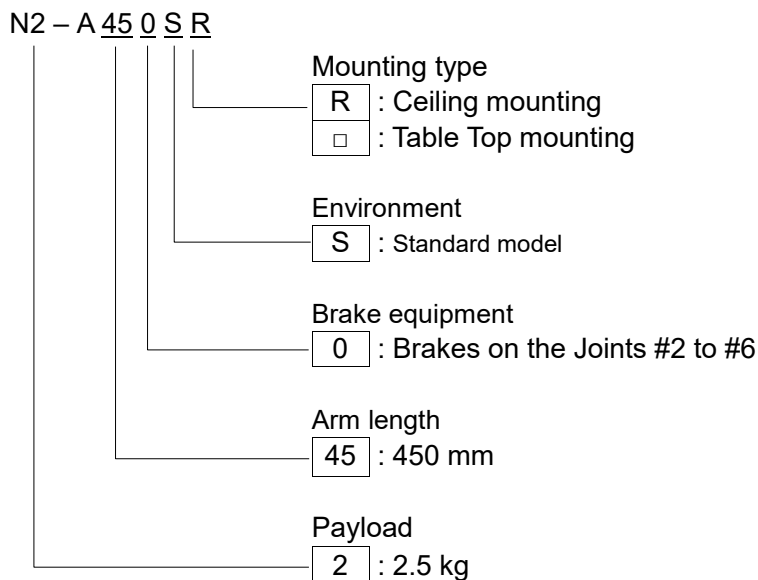

Manipulators are set to “Ceiling mounting” at shipment. To use the Manipulators as “Table Top mounting”, you need to change the model settings.

For details on how to change the model settings, refer to *5.4 Changing the Robot*, and *EPSON RC+ User’s Guide Robot Configuration*.

2.3 Part Names

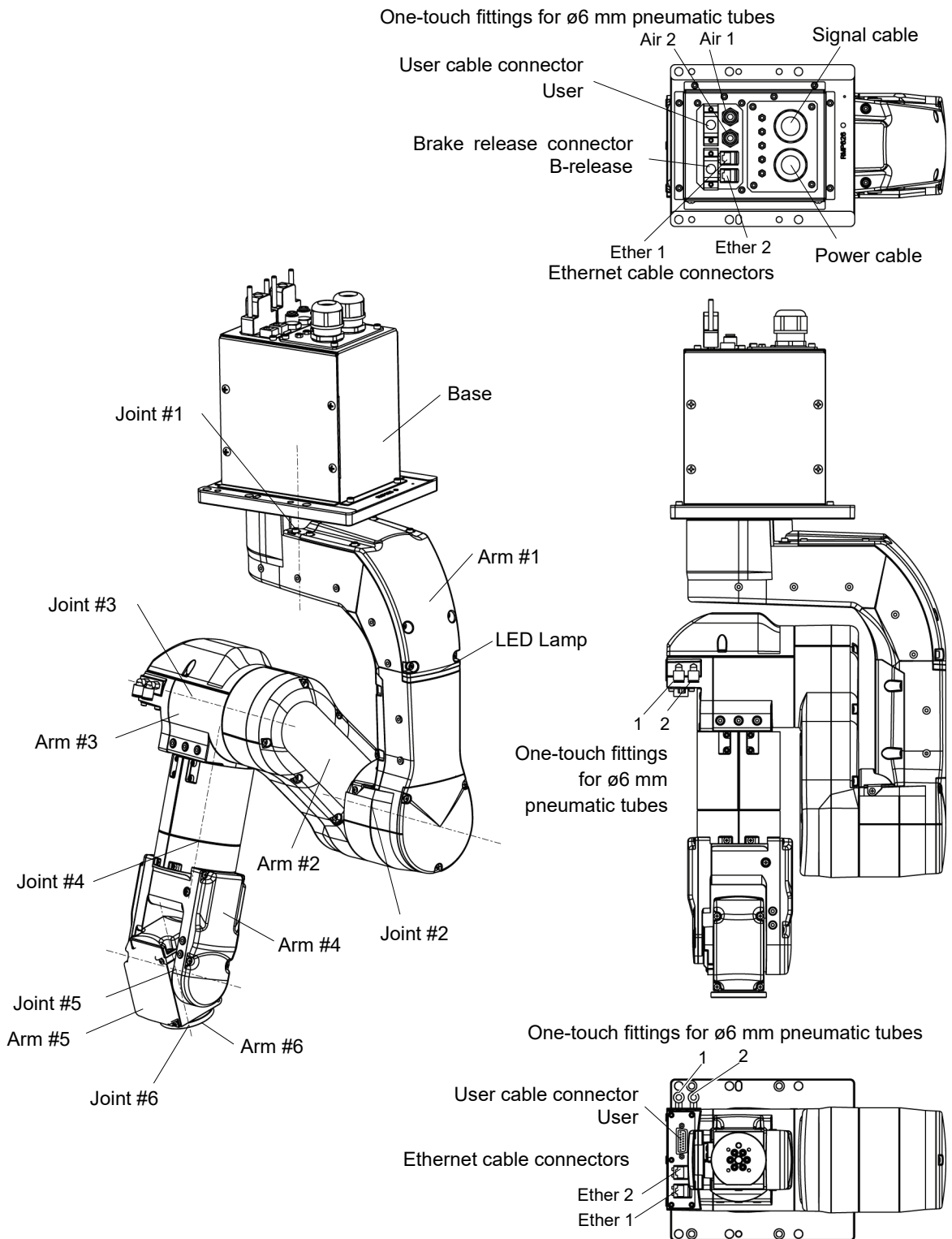

**NOTE**  When the LED lamp is lighting or the Controller power is on, the current is being applied to the Manipulator. (The LED lamp may not be seen depending on the Manipulator's posture. Be very careful.) Performing any work with the power ON is extremely hazardous and it may result in electric shock and/or improper function of the robot system. Make sure to turn OFF the Controller power before the maintenance work.

## 2.4 Outer Dimensions

[Unit: mm]

### 2.4.1 S/N: N201000001~N201010000

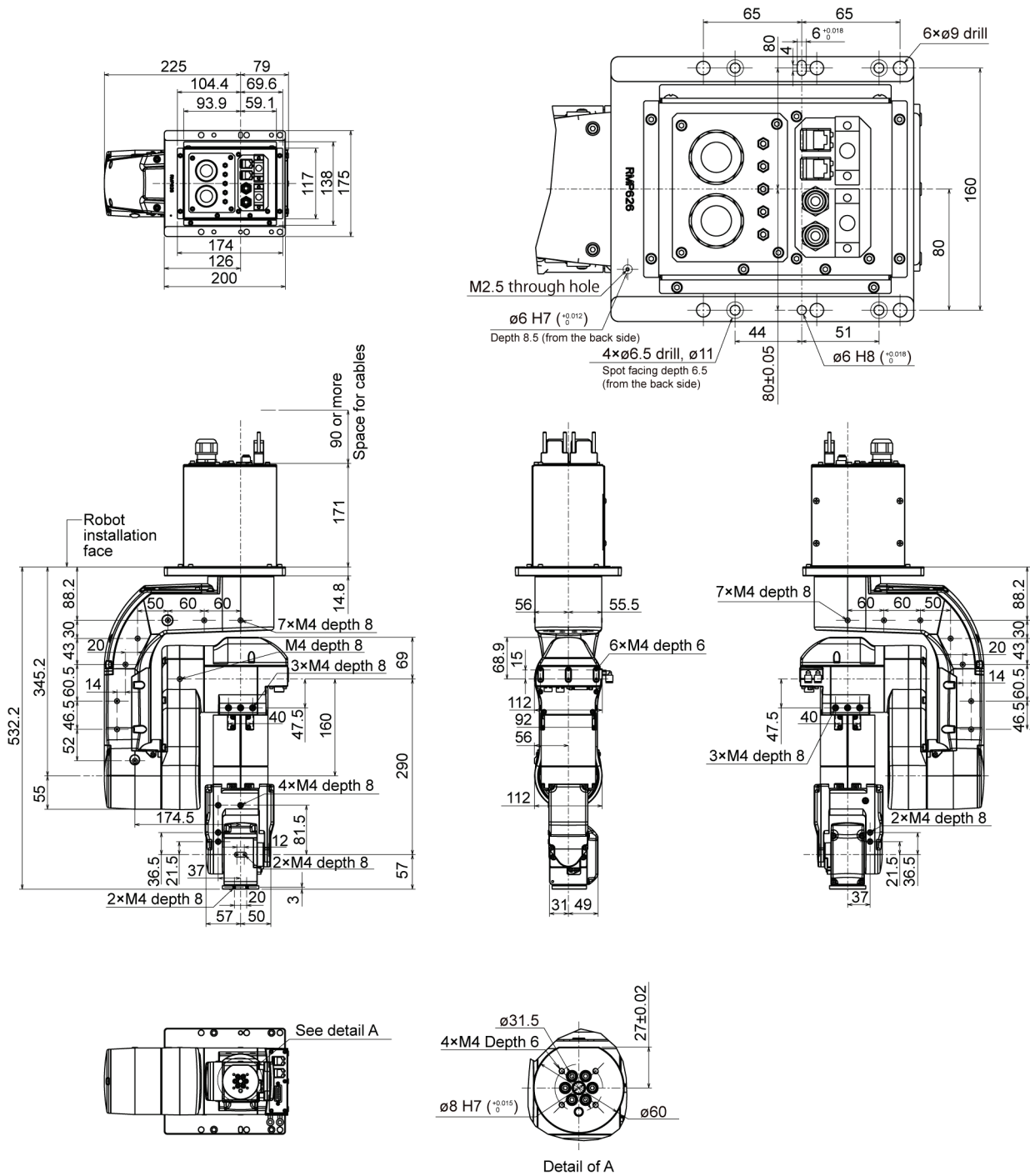

2.4.2 S/N: N201010001 or later

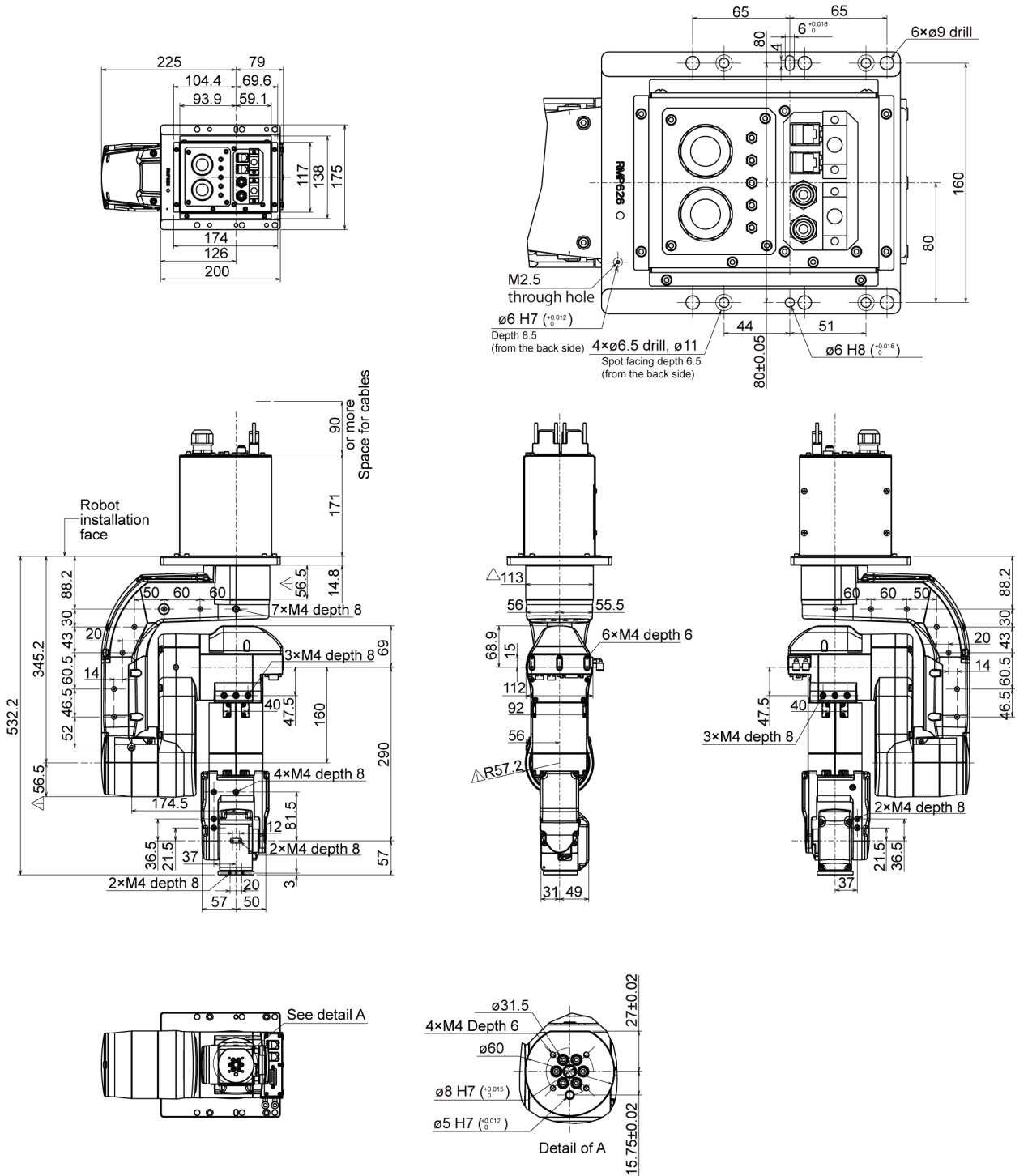

△: Difference from "2.4.1 S/N: N201000001~N201010000"

## 2.5 Standard Motion Range

[Unit: mm]

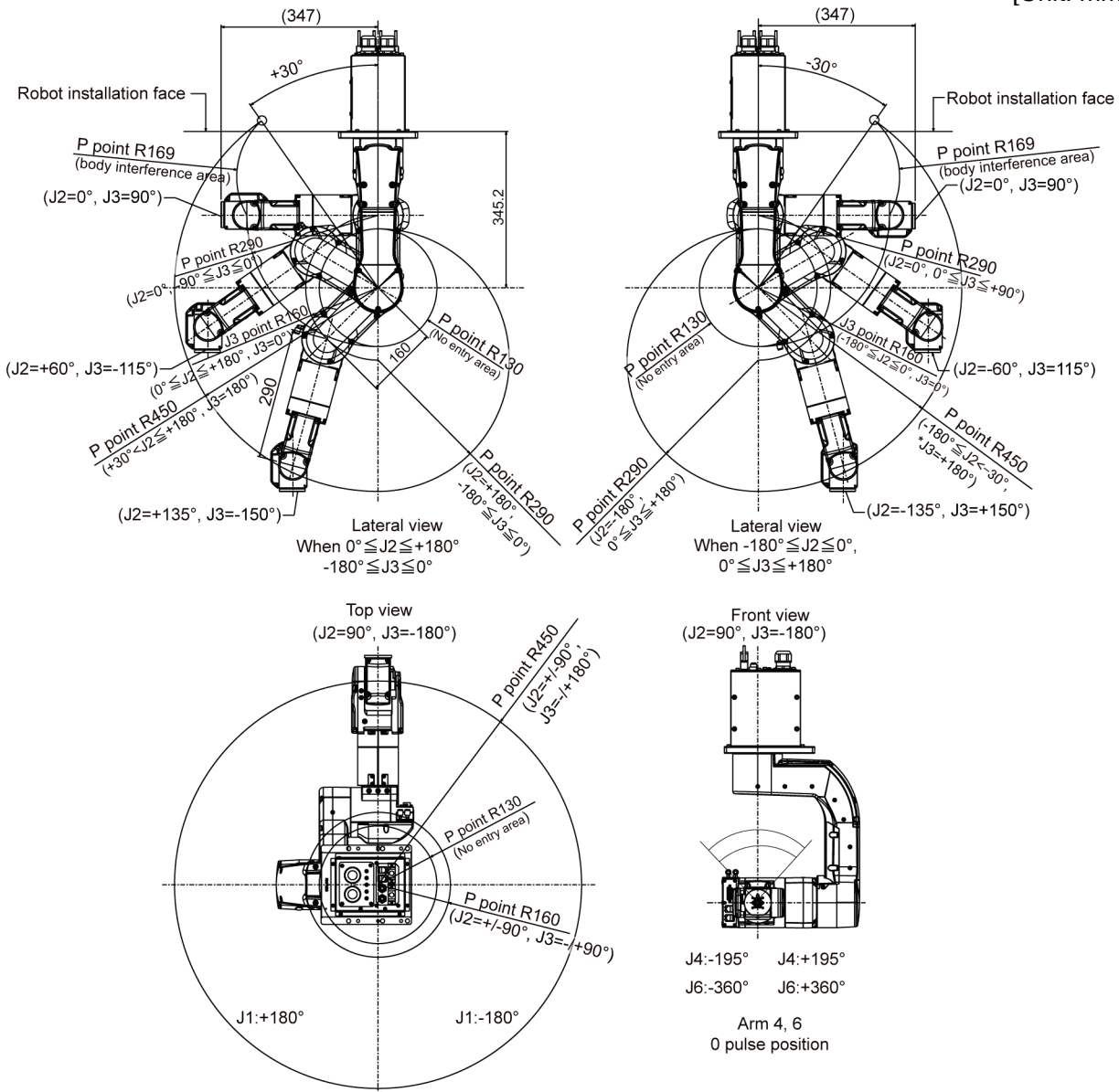

(°: degree)

\* P point : Intersection of the rotation centers for Joint #4, #5, and #6

 <b>CAUTION</b>	<p>■ Pay attention to the arm pose of the basic arms (Arms #1, #2, and #3) when operating the Manipulator. Arm #5 moves keeping a constant angle regardless of the arm pose. Depending on the arm pose of the basic arms, the wrist may collide with the Manipulator. The collision may cause equipment damage to and/or malfunction of the Manipulator.</p>
---	--

## 2.6 Specifications

### 2.6.1 Specifications table

Item		Specification
Model Number		N2-A450SR      N2-A450S
Model Name		N2
Mounting type		Ceiling mounting      Table Top mounting <sup>*1</sup>
Weight (excluding cables)		19 kg (42 lbs.)
Driving method	All joints	AC servo motor
Max. operating speed <sup>*2</sup>	Joint #1	297°/s
	Joint #2	297°/s
	Joint #3	356°/s
	Joint #4	356°/s
	Joint #5	360°/s
	Joint #6	360°/s
Maximum synthetic speed		5772 mm/s
Repeatability	Joint #1 ~ #6	± 0.02 mm
Max. motion range	Joint #1	± 180°
	Joint #2	± 180°
	Joint #3	± 180°
	Joint #4	± 195°
	Joint #5	± 130°
	Joint #6	± 360°
Max. pulse range	Joint #1	± 7929856 pulse
	Joint #2	± 7929856 pulse
	Joint #3	± 6619136 pulse
	Joint #4	± 7170731 pulse
	Joint #5	± 4733156 pulse
	Joint #6	± 13107200 pulse
Resolution	Joint #1	0.0000227°/pulse
	Joint #2	0.0000227°/pulse
	Joint #3	0.0000272°/pulse
	Joint #4	0.0000272°/pulse
	Joint #5	0.0000275°/pulse
	Joint #6	0.0000275°/pulse
Motor rated capacity	Joint #1	100 W
	Joint #2	100 W
	Joint #3	100 W
	Joint #4	30 W
	Joint #5	30 W
	Joint #6	15 W
Payload <sup>*3</sup>	Rated	1 kg
	Max.	2.5 kg
Allowable moment	Joint #4	5.4 N·m (0.55 kgf·m)
	Joint #5	5.4 N·m (0.55 kgf·m)
	Joint #6	2.4 N·m (0.24 kgf·m)
Allowable moment of inertia (GD2/4) <sup>*4</sup>	Joint #4	0.2 kg·m <sup>2</sup>
	Joint #5	0.2 kg·m <sup>2</sup>
	Joint #6	0.08 kg·m <sup>2</sup>
Installed wire for customer use		15 wires (D-sub) 8 pin (RJ45) Cat 5e or equivalent (2 cables) (also used for Force Sensor)

Installed pneumatic tube for customer use *5		ø6 mm pneumatic tubes (2 tubes), Allowable pressure: 0.59 MPa (6 kgf/cm <sup>2</sup> ) (86 psi)
Item		Specification
Model Number		N2-A450SR, N2-A450S
Model Name		N2
Environmental requirements *6	Ambient Temperature	5 to 40 °C
	Ambient relative humidity	10 to 80% (no condensation)
	Vibration	4.9 m·s <sup>-2</sup> (0.5 G) or less
Noise level *7		LAeq = 80 dB (A) or under
Applicable Controller		RC700-A
Default values (Max. setting values)	SPEED	5 (100)
	ACCEL *8	5, 5 (120, 120)
	SPEEDS	50 (1120)
	ACCELS	200 (5000)
	FINE	10000, 10000, 10000, 10000, 10000, 10000 (65535, 65535, 65535, 65535, 65535, 65535)
	WEIGHT	1 (2.5)
	INERTIA	0.005 (0.08)
Safety standard		CE Marking : EMC Directive, Machinery Directive KC Marking / KCs Marking ANSI/RIA R15.06-2012 NFPA 79 (2007 Edition)

\*1: Manipulators are set to “Ceiling mounting” at shipment.

To use the Manipulators as “Table Top mounting”, you need to change the model settings.

Mounting types other than “Ceiling mounting” and “Table Top mounting” are out of specification.

If you prefer other mounting types, please contact the supplier of your region.

For details on how to change the model settings, refer to *5.4 Changing the Robot*, and *EPSON RC+ User’s Guide Robot Configuration*.

\*2: In case of PTP control

\*3: Do not apply the load exceeding the maximum payload.

\*4: If the center of gravity is at the center of each arm. If the center of gravity is not at the center of each arm, set the eccentric quantity using INERTIA command.

\*5: For details of the installed pneumatic tube for customer use, refer to the *Setup & Operation 3.7 User Wires and Pneumatic Tubes*.

\*6: For details of the environmental requirements, refer to the *Setup & Operation 3.1 Environmental Conditions*.

\*7: Conditions of Manipulator at measurement are as follows:

Operating conditions: Under rated load, 6 arms simultaneous motion, maximum speed,  
maximum acceleration, and duty 50%.

Measurement point: 1000 mm apart from the rear of Manipulator

\*8: In general use, Accel setting 100 is the optimum setting that maintains the balance of acceleration and vibration when positioning. Although values larger than 100 can be set to Accel, it is recommended to minimize the use of large values to necessary motions since operating the Manipulator continuously with the large Accel setting may shorten the product life remarkably.



## 2.6.2 Option

N2 series have the following options. For details, refer to *Setup & Operation 6. Options*.

### Brake release unit

The option for moving the arms manually by turning OFF the Solenoid brakes.

For EU : Power supply voltage 200 V, short connector included

For US/JP : Power supply voltage 100 V, short connector included

Short connector for the brake release unit

When using the brake release unit with the N2 series Manipulator, it is necessary to connect the short connector to the M/C power cable, or connect the M/C power cable with the Controller. (The brake release unit can be used while the Controller is de-energized state.)

If you are using C3 or C4 series Manipulator and already have the brake release unit, you can use it by connecting the M/C cable with the Controller, or purchasing the short connector separately and connecting it to the M/C power cable.

### Camera plate unit

The option for mounting the camera to the Manipulator.

### Tool adapter (ISO flange)

The option for mounting the end effector whose dimensions are designed for the ISO flange to the N2 series Manipulators.

### User wires

The option for using the internal wiring for the end effector drive.

Standard user connector kit: Standard D-sub 15-pin × 2

### Wiring guide

The guide tool for wiring the user wires and pneumatic tubes.

Leave marginal length for the cables and tubes according to the operating specifications of your system.

### Table Top mount bracket

The bracket for table top mounting.

It is also possible to install the Manipulator on the base table by making an installation hole like ceiling mounting.

### Calibration plate

The option used for calibration.

It helps to perform calibration with higher accuracy than calibration using the origin position marks (0 pulse position) on the exterior of the Manipulator.

## 2.7 How to Set the Model

The Manipulator for your system has been set before shipment.



CAUTION

- When you need to change the setting of the Manipulator model, be sure to set the Manipulator model properly. Improper setting of the Manipulator model may result in abnormal or no operation of the Manipulator and/or cause safety problems.

### NOTE



If the custom specifications number (MT\*\*\*) is described on MODEL of the signature label (S/N label), the Manipulator has custom specifications. (A label with only the custom specifications number may be attached depending on shipment time.)

The custom specifications may require a different configuration procedure; check the custom specifications number (MT\*\*\*) and contact the supplier of your region when necessary.

The Manipulator model can be set from software.

Refer to the chapter *Robot Configuration* in the *EPSON RC+ User's Guide*.

## 3. Environment and Installation

Installation and transportation of robots and robotic equipment shall be performed by qualified personnel and should conform to all national and local codes.

### 3.1 Environmental Conditions

A suitable environment is essential for the robot system to function properly and safely. Be sure to install the robot system in an environment that meets the following conditions:

Item	Conditions
Ambient temperature* <sup>1</sup>	5 to 40 °C
Ambient relative humidity	10 to 80% (no condensation)
First transient burst noise	2 kV or less (Power supply wire) 1 kV or less (Signal wire)
Electrostatic noise	4 kV or less
Environment	<ul style="list-style-type: none"> <li>- Install indoors.</li> <li>- Keep away from direct sunlight.</li> <li>- Keep away from dust, oily smoke, salinity, metal powder or other contaminants.</li> <li>- Keep away from flammable or corrosive solvents and gases.</li> <li>- Keep away from water.</li> <li>- Keep away from shock or vibration.</li> <li>- Keep away from sources of electric noise.</li> </ul>

\*1 The ambient temperature conditions are for the Manipulators only. For the Controller which the Manipulator is connected to, refer to the Controller manual.



When using the Manipulators in inadequate environments that do not meet the above conditions, please contact the supplier of your region.

#### Special Environmental Conditions

The surface of the Manipulator has general oil resistance. However, if your requirements specify that the Manipulator must withstand certain kinds of oil, the supplier of your region.

Rapid change in temperature and humidity can cause condensation inside the Manipulator. If your requirements specify that the Manipulator handles food, please co the supplier of your region to check whether the Manipulator will damage the food or not.

The Manipulator cannot be used in corrosive environments where acid or alkaline is used. In a salty environment where the rust is likely to gather, the Manipulator is susceptible to rust.

 <b>WARNING</b>	<ul style="list-style-type: none"> <li>■ Use an earth leakage breaker on the AC power cable of the Controller to avoid the electric shock and circuit breakdown caused by short circuit. Prepare the earth leakage breaker that pertains the Controller you are using. For details, refer to the Controller manual.</li> </ul>
--------------------	--

 <b>CAUTION</b>	<ul style="list-style-type: none"> <li>■ When cleaning the Manipulator, do not rub it strongly with alcohol or benzene. It may lose luster on the coated face.</li> </ul>
--------------------	---

### 3.2 Unpacking, Transportation, and Relocation

Using a cart or similar equipment, transport the Manipulator in the same conditions as it was delivered. Observe the following when unpacking the Manipulator.

The installation shall be made by qualified installation personnel and should conform to all national and local codes.

 WARNING	<ul style="list-style-type: none"> <li>■ Only authorized personnel should perform sling work and operate a crane or a forklift. When these operations are performed by unauthorized personnel, it is extremely hazardous and may result in serious bodily injury and/or severe equipment damage to the robot system.</li> <li>■ Stabilize the Manipulator with your hands when hoisting it. Unstable hoisting is extremely hazardous and may result in serious bodily injury and/or severe equipment damage to the robot system as the fall of the Manipulator.</li> </ul>
--	--

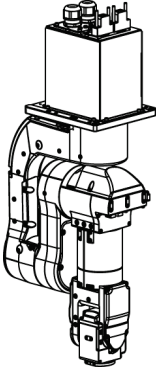
 CAUTION	<ul style="list-style-type: none"> <li>■ When removing the anchor bolts, support the Manipulator to prevent falling. Removing the anchor bolts without supporting the Manipulator may get hands, fingers, or feet caught as the Manipulator may fall.</li> <li>■ To carry the Manipulator, be sure to have at least 2 people to hold the bottom of the base or the Arm by hand. When holding the base installation face by hand, be careful not to cause your hands and fingers caught.</li> </ul> <div style="text-align: center; margin: 10px 0;">  <p>Manipulator weight: 19 kg: 42 lbs.</p> </div> <ul style="list-style-type: none"> <li>■ Avoid excessive vibration or shock during Manipulator transporting. Excessive vibration or shock may cause equipment damage to and/or malfunction of the Manipulator.</li> </ul>
--	---

Be sure to transport and store the robot system in environments that meet the following conditions:

Item	Conditions
Ambient temperature	0 to 45 °C
Ambient relative humidity	10 to 80 % (no condensation)

During unpacking and relocation, avoid applying external force to the arms and motors of the Manipulator.

When transporting the Manipulator for a long distance, secure it to the delivery equipment so that the Manipulator cannot fall. If necessary, pack the Manipulator in the same way as it was delivered.

When condensation occurs on the Manipulator during transport or storage, turn ON the power only after the condensation dries.

When using the Manipulator for the robot system again after long-term storage, perform a test run to verify that the Manipulator works properly. Then, operate the Manipulator thoroughly.

### Relocating

Follow the procedures described below when relocating the Manipulator.

- (1) Turn ON the Controller.
- (2) Change the Manipulator posture so that it is easy to support when removing it.

Recommended posture: Joint #2 – 45°  
Joint #3 – 45°

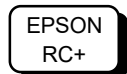

Command

```
> Go AglToPls(0, -45, -45, 0, 0, 0)
```

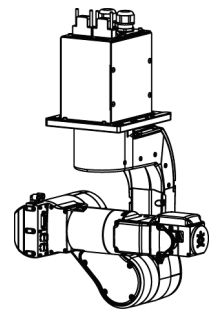

- (3) Turn OFF the power for all devices and unplug the power cable connector and signal cable connector from the Controller.

Do not unplug the M/C cable (power cable and signal cable) from the Manipulator.  
(M/C cable 3 m: 2 kg)

- (4) Unscrew the anchor bolts. Then, remove the Manipulator from the base table.
- (5) Secure the Manipulator to the delivery equipment or have at least 2 people to carry the Manipulator.
- (6) After installing the Manipulator, turn ON the Controller.
- (7) Return the Manipulator to the basic orientation.

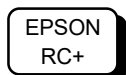

Command

```
> Pulse 0, 0, 0, 0, 0, 0
```

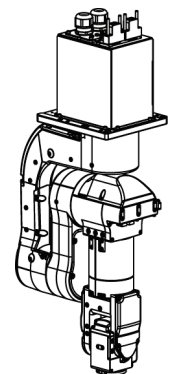

### NOTE



The Joint #1 is not equipped with the brake. When installing the Manipulator, be careful not to rotate the Joint #1.

The cable may break when exceeding Max. motion range. Be careful when operating.

### 3.3 Mounting Dimensions

#### Mounting Area

Be sure to have the following space available in addition to the space for mounting the Manipulator, Controller, and peripheral equipment.

- Space for teaching points
- Space for maintenance and inspections (for installing jigs)
- Space for cables
- Space for mounting holes (only for V/P model)



The minimum bend radius of the power cable is 90 mm. When installing the cable, be sure to maintain sufficient distance from obstacles. In addition, leave enough space for other cables so that they are not bent forcibly.

[Unit: mm]

#### Mounting dimensions

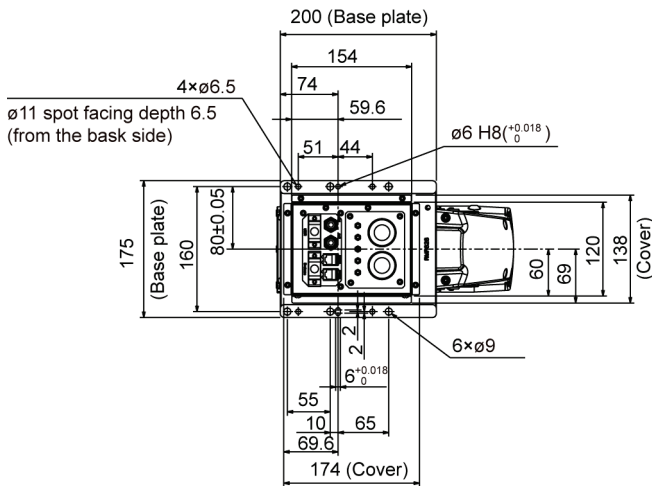

#### Motion range

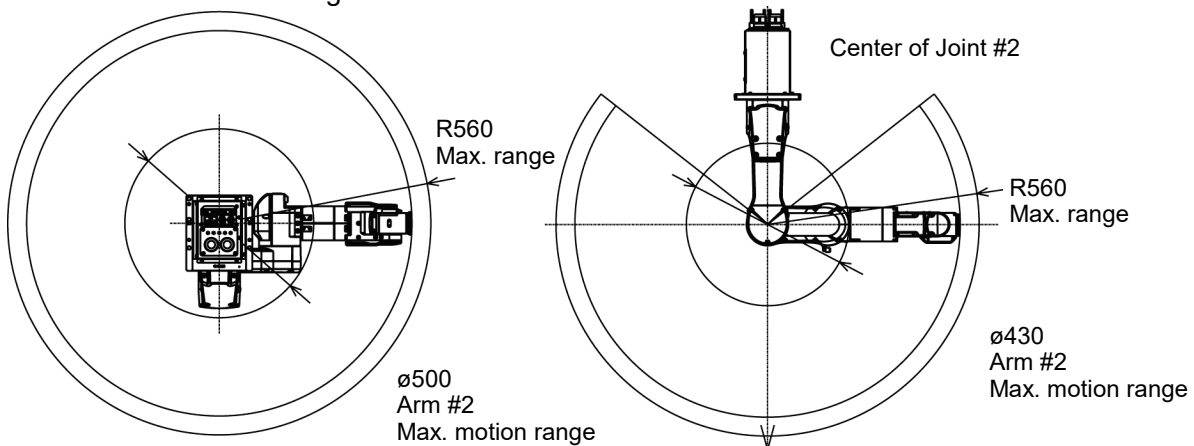

The maximum ranges in the above figure are the case when the end effector is 50 mm. If the end effector is longer than 50 mm, or the camera or the electromagnetic valve attached on the Arm is large, define the max motion ranges by considering the area where these tools may reach.

### 3.4 Installation

The installation shall be made by qualified installation personnel and should conform to all national and local codes.

 WARNING	<ul style="list-style-type: none"> <li>■ To ensure safety, a safeguard must be installed for the robot system. For details on the safeguard, refer to the <i>Installation and Design Precautions</i> in the <i>Safety</i> chapter of the EPSON RC+ User's Guide.</li> <li>■ Install the Manipulator in a location with sufficient space so that a tool or a work piece does not touch a wall or a safeguard when the Manipulator extends its arm fully while holding a work piece. Installing the Manipulator at a location with insufficient space is extremely hazardous and may result in serious bodily injury and/or severe equipment damage to the robot system as a tool or a work piece may collide with a wall or a safeguard.</li> <li>■ Anchor the Manipulator before turning ON the power to or operating the Manipulator. Turning ON the power to or operating the Manipulator that is not anchored is extremely hazardous and may result in serious bodily injury and/or severe equipment damage to the robot system as the Manipulator may fall down.</li> <li>■ Before installing and operating the Manipulator, make sure that all parts of the Manipulator are in place and have no external defects. Missing or defective parts may cause improper operation of the Manipulator. Improper operation of the Manipulator is extremely hazardous and may result in serious bodily injury and/or severe equipment damage to the robot system.</li> </ul>
--	---

 CAUTION	<ul style="list-style-type: none"> <li>■ The Manipulator must be installed to avoid interference with buildings, structures, utilities, other machines and equipment that may create a trapping hazard or pinch points.</li> <li>■ Oscillation (resonance) may occur during operation depending on rigidity of the installation table. If the oscillation occurs, improve rigidity of the table or change the speed or acceleration and deceleration settings.</li> </ul>
--	---

#### Mounting bolt

For the dimensions, refer to Setup & Operation 3.3 Mounting Dimensions.

There are four threaded holes for the Manipulator base.

Use M6 mounting bolts conforming to the strength of ISO898-1 property class 10.9 or 12.9.

Tightening torque: 13 N·m (133 kgf·cm)

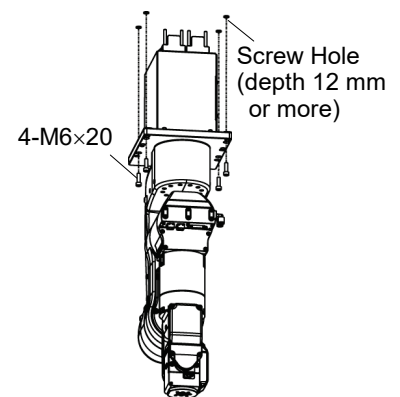

### Example of working space (recommended)

The base and the base cover need to be removed when performing maintenance and inspection. Leave ample space around the base for maintenance (such as battery replacement) and inspection.

#### Recommended space

Above the base: About 400 mm from the base plate

Side of the base: About 200 mm from the base cover and the base

**NOTE**  When the working space is not left, the Manipulator needs to be removed from the working table for maintenance and inspection.

#### Example: When replacing the battery

##### Removing the base

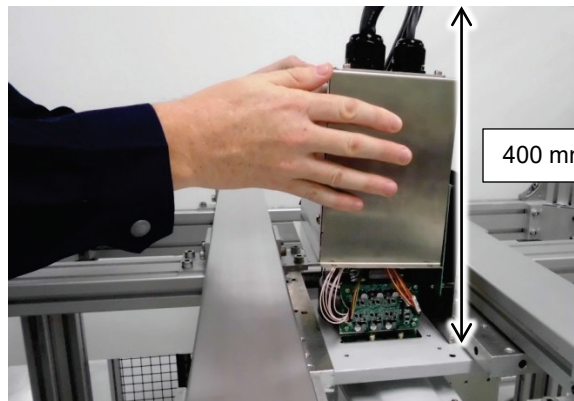

Leave about 400 mm above the base plate.  
(in case of ceiling mount Manipulator)

##### Removing the base cover

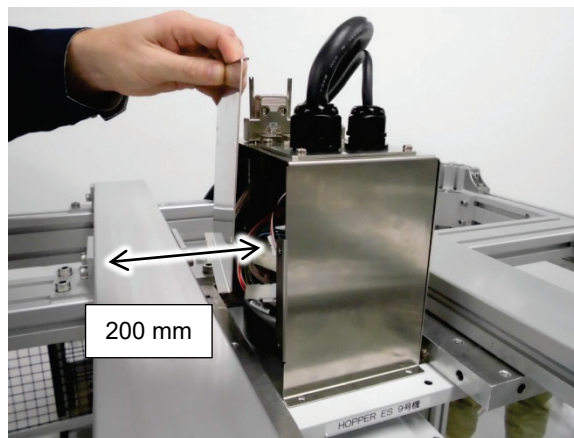

Leave about 200 mm from the base cover.

Removal and installation procedures of the base cover are described in the following section.

#### *Maintenance*

##### *3.15 Base Cover*



### 3.5 Base Table

A base table for anchoring the Manipulator is not supplied. Please make or obtain the base table for your Manipulator. The shape and size of the base table differ depending on the intended use of the robot system. The following is the basic requirements of Manipulator table for your reference.

The base table must not only be able to bear the weight of the Manipulator but also be able to withstand the dynamic movement of the Manipulator when it operates at maximum acceleration. Ensure that there is enough strength on the base table by attaching reinforcing materials such as crossbeams.

The torque and reaction force produced by the movement of the Manipulator are as follows:

Model number	N2-A450S*
Model name	N2
Max. Horizontal rotating torque (N·m)	200
Max. Horizontal reaction force (N)	300
Max. Vertical rotating torque (N·m)	300
Max. Vertical rotating torque (N)	1600

The plate for the Manipulator mounting face should be 20 mm thick or more and made of steel to reduce vibration.

The surface roughness of the steel plate should be 25 μm or less.

The base table must be secured on the floor to prevent it from moving.

The Manipulator must be installed horizontally.

When using a leveler to adjust the height of the base table, use a screw with M16 diameter or more.

#### Connector

If you are passing cables through the holes on the base table, see the figures below.

[unit : mm]

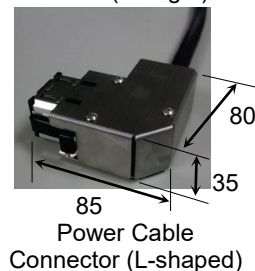
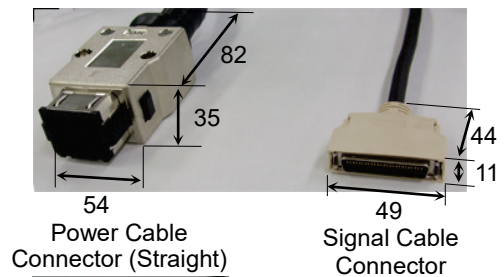
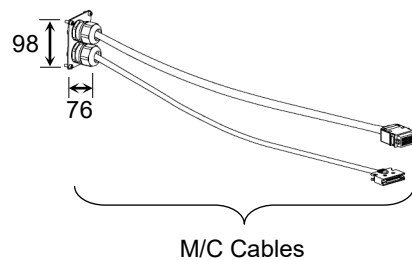

Do not remove the M/C cables from the Manipulator.

**NOTE** For environmental conditions regarding space when placing the Controller on the base table, refer to the Controller manual.

 <p><b>WARNING</b></p>	<p>■ To ensure safety, a safeguard must be installed for the robot system. For details on the safeguard, refer to the <i>EPSON RC+ User's Guide</i>.</p>
---	--

### Base Table – Design Example

The following is an example for designing the base table of the N2 Manipulator.  
During the operation of N2 in the maximum acceleration/deceleration speed, the base table must be steady enough to prevent the vibration from transmitting to N2.

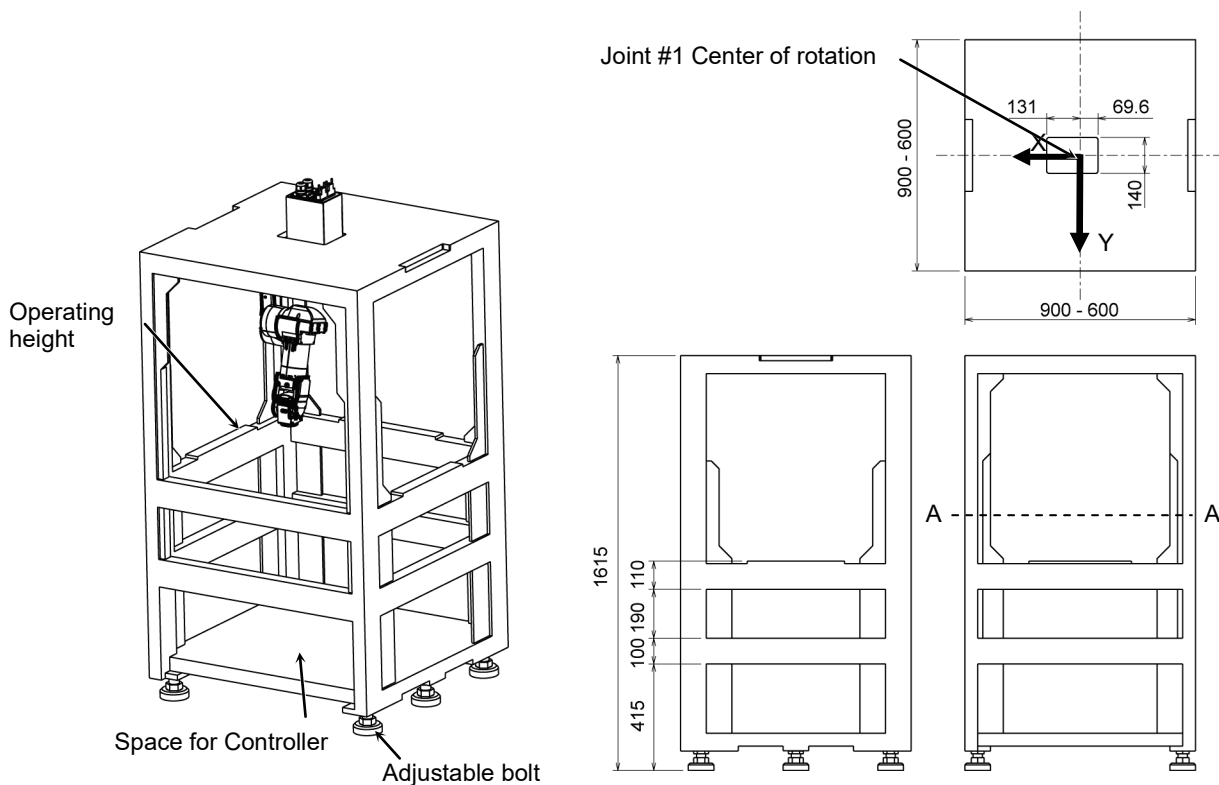

- |                               |  |
|-------------------------------|--|
| Wight of table                | : approx. 300 kg (□900) to approx. 250 kg (□600)                               |
| Material for the flame        | : Iron pipe: □ 100 × 50 mm<br>Thickness: 3.2 mm (□900) to 6 mm (□600)          |
| Adjustable bolt               | : M36  |
| Geometrical moment of inertia | : $I_x = 1.2 \times 10^9 \text{ mm}^4$<br>$I_y = 1.2 \times 10^9 \text{ mm}^4$ |

- Set low aspect ratio of the base table height and width.
- Put center of gravity lower position by installing the Controller on the bottom of the base table.
- Reinforce the open part with joist or similar material to minimize the part.
- The condition depends on the table height, width, the position of joist, and the center of gravity.

### 3.6 Connecting the Cables



WARNING

- Before performing any replacement procedure, turn OFF the Controller and related equipment, and then disconnect the power plug from the power source. Performing any replacement procedure with the power ON is extremely hazardous and may result in electric shock and/or malfunction of the robot system.
- Be sure to connect the AC power cable to a power receptacle. DO NOT connect it directly to a factory power source. To shut off power to the robot system, disconnect the power plug from the power source. Performing any work while connecting the AC power cable to a factory power source is extremely hazardous and may result in electric shock and/or malfunction of the robot system.
- Be sure to connect the cables properly. Do not allow unnecessary strain on the cables. (Do not put heavy objects on the cables. Do not bend or pull the cables forcibly.) The unnecessary strain on the cables may result in damage to the cables, disconnection, and/or contact failure. Damaged cables, disconnection, or contact failure is extremely hazardous and may result in electric shock and/or improper function of the robot system.
- Before wiring, turn OFF the Controller and related equipment, and then pull up a warning sign (e.g. DO NOT TURN ON THE POWER.). Wiring with the power ON is extremely hazardous and may result in electric shock and/or malfunction of the robot system.
- When connecting or replacing the brake release unit and the external short connector, turn OFF the power to the Controller and the brake release unit. Inserting and removing the connector while the power is ON may result in electrical shock.



CAUTION

- When connecting the Manipulator and the Controller, make sure that the serial numbers on each equipment match. Improper connection between the Manipulator and Controller may not only cause improper function of the robot system but also safety problems. The connection method varies with the Controller used. For details on the connection, refer to the Controller manual.
- Only authorized or certified personnel should be allowed to perform wiring. Wiring by unauthorized or uncertified personnel may result in bodily injury and/or malfunction of the robot system.
- If the Manipulator is operated without connecting the brake release unit and the external short connector, the brakes cannot be released and it may cause damage on them. After using the brake release unit, be sure to connect the external short connector to the Manipulator, or check connection of the connector for the brake release unit.

M/C Cable Connection method

Connect the power connector and the signal connector of the M/C cables to the Controller.

 <b>WARNING</b>	<ul style="list-style-type: none"> <li>When using metal ducts, metallic conduits, or distributing racks for cable, ground in accordance with national and local electric equipment technical standards. Grounding that does not meet the standards may result in electric shock and/or malfunction of the robot system.</li> </ul>
---	--

3.7 User Wires and Pneumatic Tubes

 <b>CAUTION</b>	<ul style="list-style-type: none"> <li>Only authorized or certified personnel should be allowed to perform wiring. Wiring by unauthorized or uncertified personnel may result in bodily injury and/or malfunction of the robot system.</li> </ul>
---	---

User electrical wires and pneumatic tubes are contained in the cable unit.

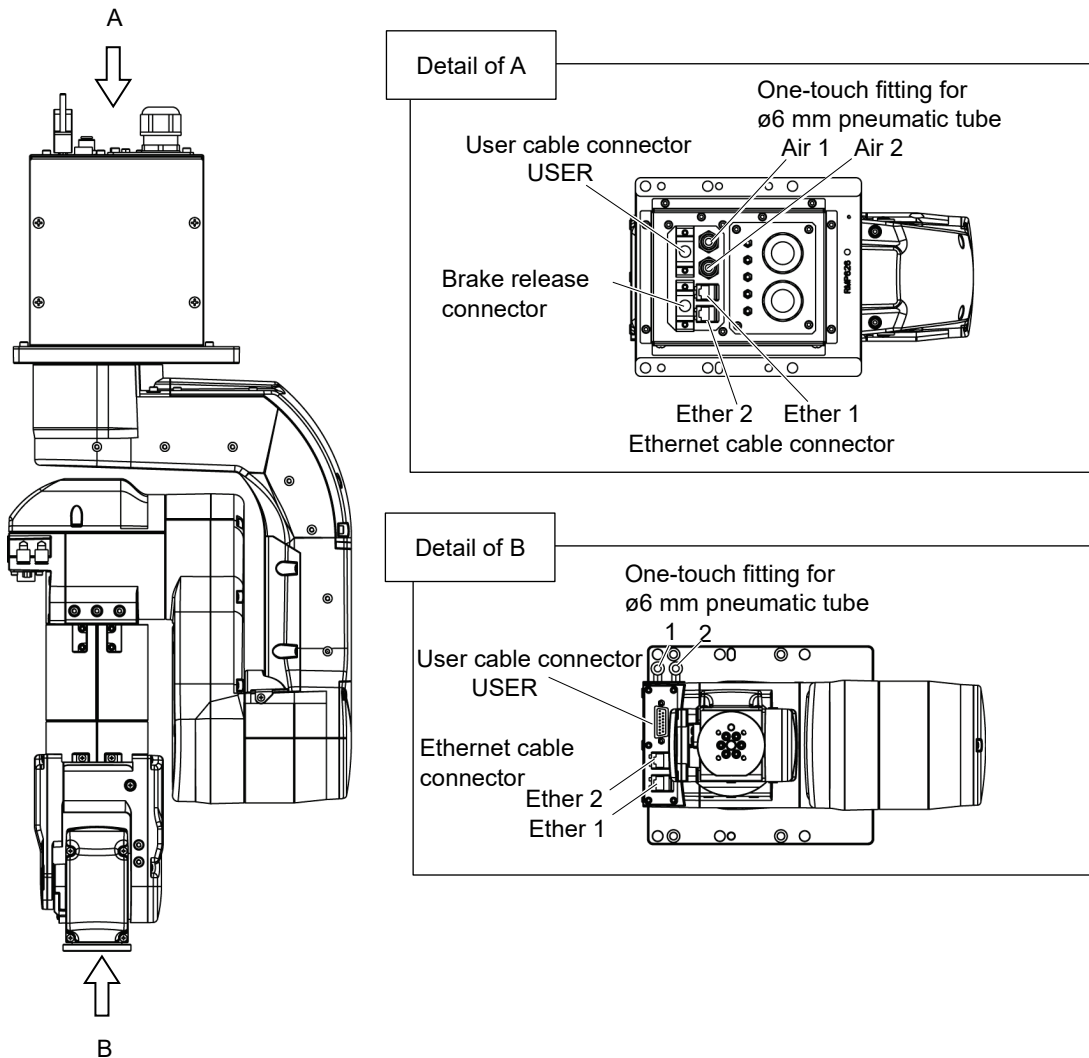

**NOTE**  The user cable connector and the brake release connector have the same shape. Be careful not to connect the wrong connector.

**NOTE**  The Ethernet cable connectors Ether 1 and Ether 2 have the same shape. Be careful not to connect the wrong connector.

## Electrical wires

### Specifications of the user wires D-sub 15-pin

Rated Voltage	Allowable Current	Wires	Nominal Sectional Area	Note
AC/DC30 V	1 A	15	0.106 mm <sup>2</sup>	Shielded

Pins with the same number, indicated on the connectors on both ends of the cables, are connected.

### Attached connector for the user wires

		Maker	Standard
15 pin	Connector	JAE	DA-15PF-N (Solder type)
	Clamp Hood	HRS	HDA-CTH(4-40)(10) (Connector setscrew: #4-40 UNC)

Two parts are attached for each.

### 8 pin (RJ45) Cat.5e or equivalent

The commercially available Ethernet cables can be used.

For details, refer to *Setup & Operation 6. Option*.

## Pneumatic tubes

Max. Usable Pneumatic Pressure	Pneumatic Tubes	Outer Diameter × Inner Diameter
0.59 MPa (6 kgf/cm <sup>2</sup> : 86 psi)	2	ø6 mm × ø4 mm

## 3.8 Checking the Basic Orientation

At the time of shipment, the basic orientation of the Manipulator shown below is set as the origin position.

After installing the Manipulator and setup the operating environment, move the Manipulator to the origin position and check if it moves to the basic position properly.

### How to return to the origin position

- (1) Turn ON the Controller.
- (2) Turn ON the Manipulator motors.

**EPSON  
RC+** Command  
> Motor On

- (3) Move the joints to the origin position.

**EPSON  
RC+** Command  
> Pulse 0, 0, 0, 0, 0, 0

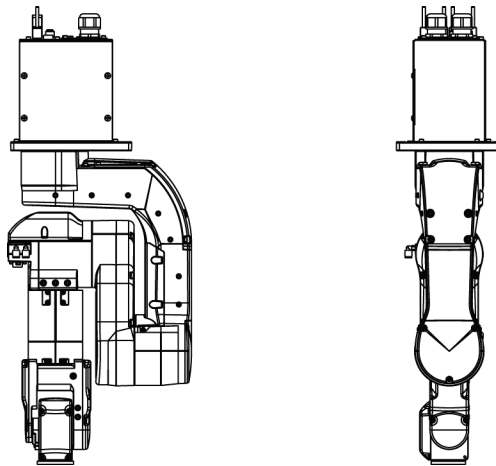

Basic Orientation

### Calibration

After parts (motors, reduction gear units, belts, etc.) have been replaced due to malfunction or any other reason, a gap occurs between the origin positions.

The process to compensate the position gap is called “Calibration”.

If the gap still exists and the Manipulator cannot be in the basic orientation after the calibration, please contact the supplier of your region.

## 4. End Effectors

### 4.1 Attaching an End Effector

Create an end effector for your Manipulator. Flange dimensions of the wrist attached to the end of Arm #6 is as below.

 <b>CAUTION</b>	<ul style="list-style-type: none"> <li>If you use an end effector equipped with a gripper or chuck, connect wires and/or pneumatic tubes properly so that the gripper does not release the work piece when the power to the robot system is turned OFF. Improper connection of the wires and/or pneumatic tubes may damage the robot system and/or work piece as the work piece is released when the Emergency Stop switch is pressed. I/O outputs are configured at the factory so that they are automatically shut off (0) by power disconnection, the Emergency Stop switch, or the safety features of the robot system.</li> </ul>
---	--

#### Wrist Flange

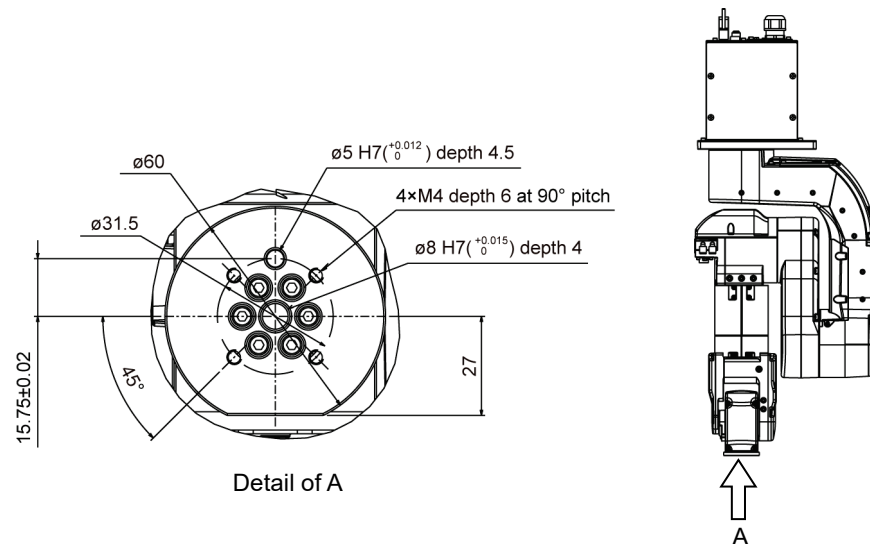

#### Arm #6

Attach an end effector to the end of the Arm #6 using the M4 bolts.

Screw depth of Arm #6 screw: 6 mm

#### Layouts

When you operate the Manipulator with an end effector, the end effector may interfere with the Manipulator body depending on the outer diameter of the end effector, the size of the work piece, or the position of the arms. When designing your system layout, pay close attention to the interference area of the end effector.

#### Compatibility with ISO flange:

For installing the end effector whose mounting dimensions are designed for the ISO flange, the optional tool adapter (ISO flange) is available.

For details, refer to *Setup & Operation: 6. Options*.

## 4.2 Attaching Camera and Air Valves

The decks are equipped to the Arms #3 and #5 for easy installation of the air valves.

To mount the camera, the camera plate unit is necessary.

The optional Camera Plate Unit is available. For details, refer to *Setup & Operation: 6. Options.*

N2-A450S\*

[Unit: mm]

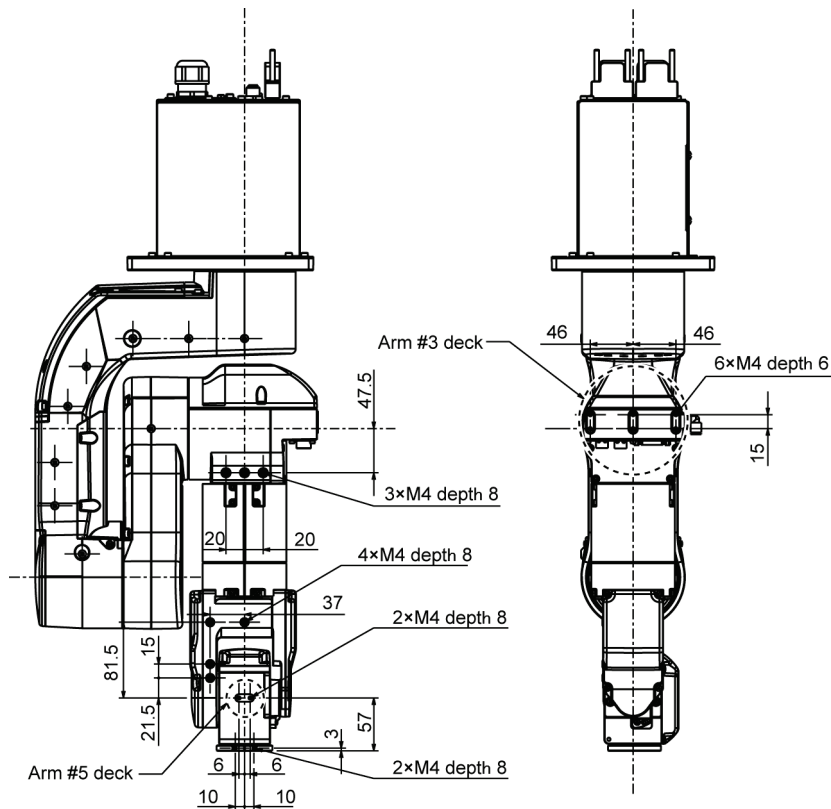



### 4.3 WEIGHT and INERTIA Settings

The WEIGHT and INERTIA (inertia moment and eccentricity) commands are for setting the load parameters of the Manipulator. These settings optimize the Manipulator motion.

#### WEIGHT Setting

The WEIGHT command is for setting the load weight. The more the load weight increases, the more the speed and acceleration/deceleration are reduced.

#### INERTIA Setting

The INERTIA command is for setting the inertia moment and the eccentricity of the load. The more the inertia moment increases, the more the acceleration and deceleration of the Arm #6 are reduced. The more the eccentricity increases, the more the acceleration and deceleration for the Manipulator movement are reduced.

To ensure optimum Manipulator performance, make sure that the load (weight of the end effector and work piece) and inertia moment of the load are within the maximum rating for the Manipulator, and that Arm #6 does not become eccentric.

If the load or the inertia moment exceeds the ratings or if the load becomes eccentric, follow the steps in the *Setup & Operation 4.3.1 WEIGHT Setting* and *4.3.2 INERTIA Setting*, to set parameters.

Setting parameters makes the operation of the Manipulator optimal, reduces vibration to shorten the operating time, and improves the capacity for larger loads. In addition, it reduces persistent vibration produced when the inertia moment of the end effector and work piece is bigger.

The allowable load for N2 series Manipulators is 2.5 kg at the maximum.

Due to the limitations of the moment and inertia moment shown in the table below, the load (end effector weight + work piece weight) should also meet these conditions.

#### Allowable Load

Joint	Allowable Moment	GD <sup>2</sup> /4 Allowable Moment of Inertia
#4	5.4 N·m (0.55 kgf·m)	0.2 kg·m <sup>2</sup>
#5	5.4 N·m (0.55 kgf·m)	0.2 kg·m <sup>2</sup>
#6	2.4 N·m (0.24 kgf·m)	0.08 kg·m <sup>2</sup>

#### Moment

The moment indicates amount of torque applied on the joint in order to support the gravity on the load (end effector + work piece).

The moment increases as weight of the load and amount of eccentricity increase. As this also increases the load applied on the joint, make sure to keep the moment within the allowable value.

#### Inertia moment

The inertia moment indicates how difficult the load (end effector + work piece) to rotate when the Manipulator joint starts to rotate (amount of inertia). The inertia moment increases as weight of the load and amount of eccentricity increase. As this also increase the load applied on the joint, make sure to keep the inertia moment within the allowable value.

The moment  $M$  (Nm) and inertia moment  $I$  ( $\text{kgm}^2$ ) when the volume of the load (end effector + work piece) is small can be obtained by the following formula.

$$M (\text{N}\cdot\text{m}) = m(\text{kg}) \times L (\text{m}) \times g (\text{m}/\text{s}^2)$$

$$I (\text{kgm}^2) = m(\text{kg}) \times L^2 (\text{m}^2)$$

- $m$  : Weight of load (kg)
- $L$  : Eccentric quantity of load (m)
- $g$  : Gravitational acceleration ( $\text{m}/\text{s}^2$ )

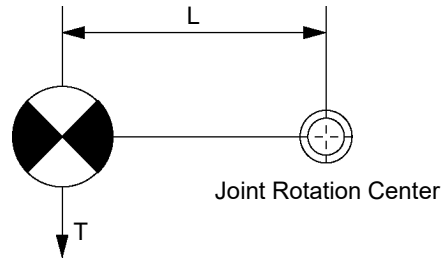

Design the end effector so that the moment  $M$  and the inertia moment  $I$  do not exceed the allowable load.

The eccentric quantity of load  $L$  should satisfy the following:

- Less than 207 mm from the Arm #5 rotation center (150 mm or less from the flange)
- Less than 150 mm from the Arm #6 rotation center

Example: When the load is 2.5 kg and the center of gravity is 100 mm from the flange:  
 $m=2.5\text{kg}$ ,  $L=100+57=157\text{mm}=0.157\text{m}$   
 The moment  $M$  and the inertia moment are below the allowable load as follows:

Moment  $M$  :  $2.5 \text{ kg} \times 0.157\text{m} \times 9.8 \text{ m}/\text{s}^2 = 3.85\text{Nm} < 5.4\text{Nm}$

Inertia moment  $I$  :  $2.5 \text{ kg} \times (0.157 \text{ m})^2 = 0.062 \text{ kgm}^2 < 0.2 \text{ kgm}^2$

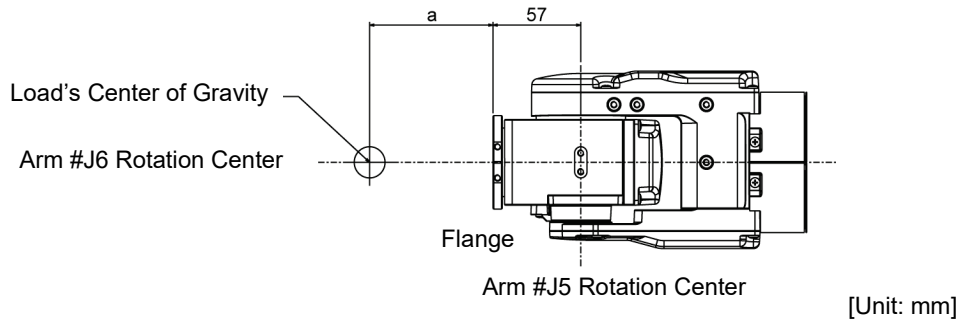

### 4.3.1 WEIGHT setting

 CAUTION	<ul style="list-style-type: none"> <li>■ Set the total weight of the end effector and the work piece smaller than the maximum payload.</li> </ul> <p>The N2 series Manipulators can operate without limitations on the condition unless and until the load exceeds this maximum payload. Always set the Weight parameters of the WEIGHT command according to the load. Setting a value that is smaller than the actual load may cause errors, excessive shock, insufficient function of the Manipulator, and/or shorten the life cycle of parts/mechanisms.</p>
-------------	---

The acceptable weight capacity (end effector and work piece) for N2 series Manipulators is as follows:

Rated	Maximum
1 kg	2.5 kg

Change the setting of the Weight parameter according to the load.

After changing the Weight parameter setting, the maximum acceleration/deceleration and speed of the robot system corresponding to the load is set automatically.

**Setting method of Weight parameters**

EPSON  
RC+

Select [Tools]-[Robot Manager]-[Weight] panel and set the value in [Weight:].

You may also execute the Weight command from [Command Window].

**Load on the Manipulator**

**Mounting location of the load**

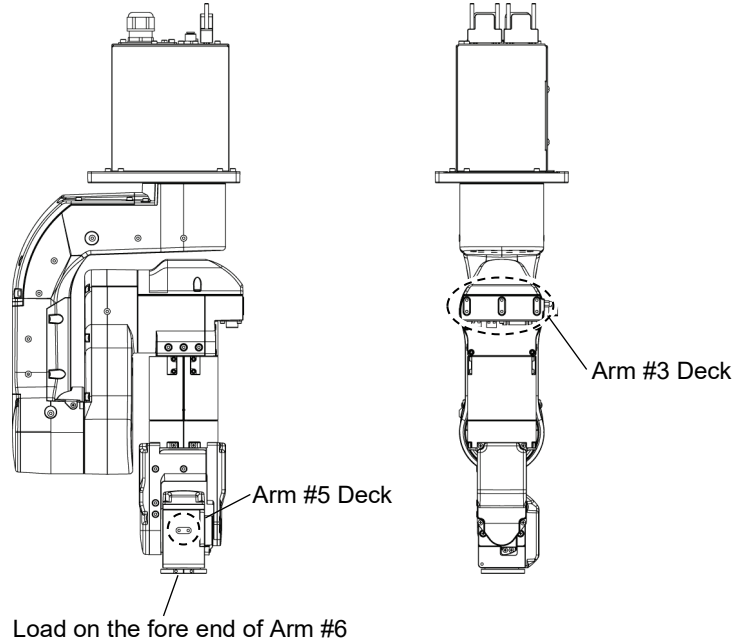

**Details of the deck**

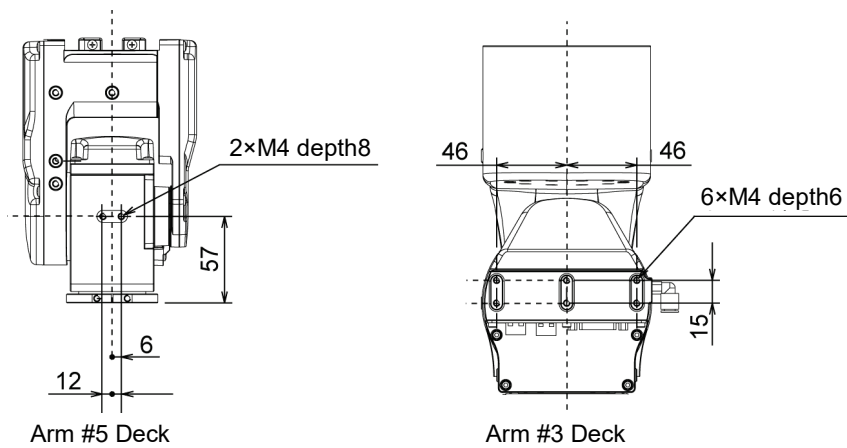

[Unit: mm]

When you attach the equipment to the decks on the upper arm, convert its weight into equivalent weight assuming that the equipment is attached to the end of the Arm #6. Then, this equivalent weight added to the load will be a Weight parameter.

Calculate the Weight parameter by using the formula below and enter the value.

**Weight Parameter Formula**

Weight parameter =  $M_w + W_a + W_b$

$M_w$  : Load on the fore end of Arm #6 (kg)  
 $W_a$  : Equivalent weight of the Arm #3 deck (kg)  
 $W_b$  : Equivalent weight of the Arm #5 deck (kg)

$W_a = M_a (L_a)^2 / (L)^2$   
 $W_b = M_b (L_b)^2 / (L)^2$

$M_a$  : Weight of the air valve on the Arm #3 deck  
 $M_b$  : Weight of the camera on the Arm #5 deck  
 $L$  : Length of the upper arm (mm)  
 $L_a$  : Distance between the Joint #3 and the center of gravity of the air valve on the Arm #3 deck (mm)  
 $L_b$  : Distance between the Joint #3 and the center of gravity of the camera on the Arm #5 deck (mm)

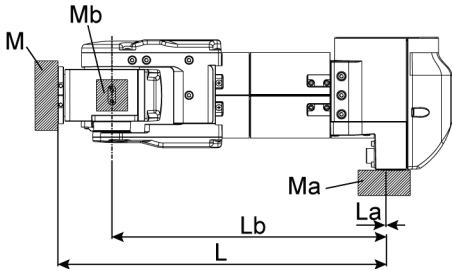

<Example> The fore end of the Arm #6 is 347 mm (L) away from the Joint #3 of N2-A450\*\*.

Load on the fore-end of Arm #6 is 1.0 kg ( $M_w$ ).

Load on the Arm #3 deck is 0.8 kg ( $M_a$ ).

The deck is 0 mm ( $L_a$ ) away from Joint #3.

Load on the Arm #5 deck is 0.5 kg ( $M_b$ ).

The deck is 290 mm ( $L_b$ ) away from the Joint #3.

$$W_a = 0.8 \times 0^2 / 347^2 = 0$$

$$W_b = 0.5 \times 290^2 / 347^2 = 0.35 \rightarrow 0.4 \text{ (round up)}$$

$$M_w + W_a + W_b = 1.0 + 0 + 0.4 = 1.4$$

Enter “1.4” for the Weight parameter.

## Automatic speed setting by Weight parameter

The percentages in the graphs are based on the speed at rated weight (1 kg) as 100%.

## N2-A450SR

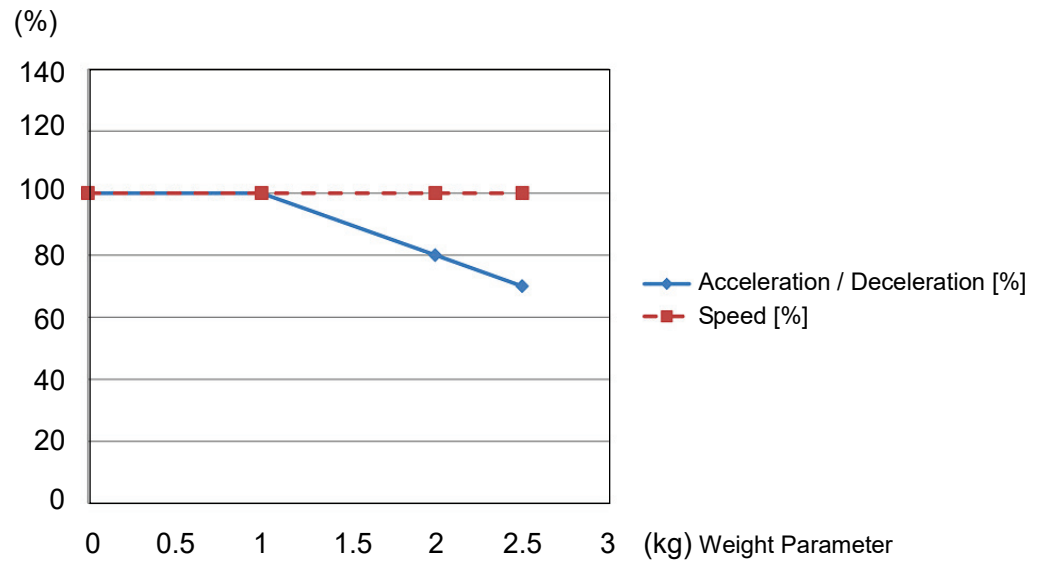

## 4.3.2 INERTIA setting

## Inertia Moment and the INERTIA Setting

The inertia moment is defined as “the ratio of the torque applied to a rigid body and its resistance to motion”. This value is typically referred to as “the moment of inertia”, “inertia”, or “GD<sup>2</sup>”. When the Manipulator operates with objects such as an end effector attached to the Arm #6, the moment of inertia of load must be considered.



- The inertia moment of the load (weight of the end effector and work piece) must be 0.08 kg·m<sup>2</sup> or less. The N2 series Manipulators are not designed to work with inertia moment exceeding 0.08 kg·m<sup>2</sup>. Always set the inertia moment (INERTIA) parameter according to the inertia moment. Setting a value that is smaller than the actual inertia moment may cause errors, excessive shock, insufficient function of the Manipulator, and/or shorten the life of parts/mechanisms.

The acceptable inertia moment of load for N2 series Manipulators is 0.005 kg·m<sup>2</sup> nominal rating and 0.08 kg·m<sup>2</sup> maximum. Change the setting of the inertia moment according to the inertia moment of the load using the INERTIA command. After the setting has been changed, the maximum acceleration/deceleration speed of Arm #6 responding to “inertia moment” is set automatically.

## Inertia moment of load on Arm #6

The inertia moment of the load (weight of the end effector and work piece) on the Arm #6 can be set by the “inertia moment (INERTIA)” parameter of the INERTIA command.



Select [Tools]-[Robot Manager]-[Inertia] panel and enter the value in [Load inertia:]. You may also execute the Inertia command from [Command Window].

Eccentric Quantity and the INERTIA Setting

 CAUTION	<ul style="list-style-type: none"> <li>The eccentric quantity of the load (weight of the end effector and work piece) must be 150 mm or less. The N2 series Manipulators are not designed to work with eccentric quantity exceeding 150 mm. Always set the eccentric quantity parameter according to the eccentric quantity. Setting a value that is smaller than the actual eccentric quantity may cause errors, excessive shock, insufficient function of the Manipulator, and/or shorten the life cycle of parts/mechanisms.</li> </ul>
--	--

The acceptable eccentric quantity of the load for N2 series Manipulators is 30 mm at nominal rating and 150 mm at maximum. When the eccentric quantity of the load exceeds the rating, change the setting of eccentric quantity parameter using the INERTIA command. After changing the setting, the maximum acceleration/deceleration speed of Manipulator corresponding to “eccentric quantity” is set automatically.

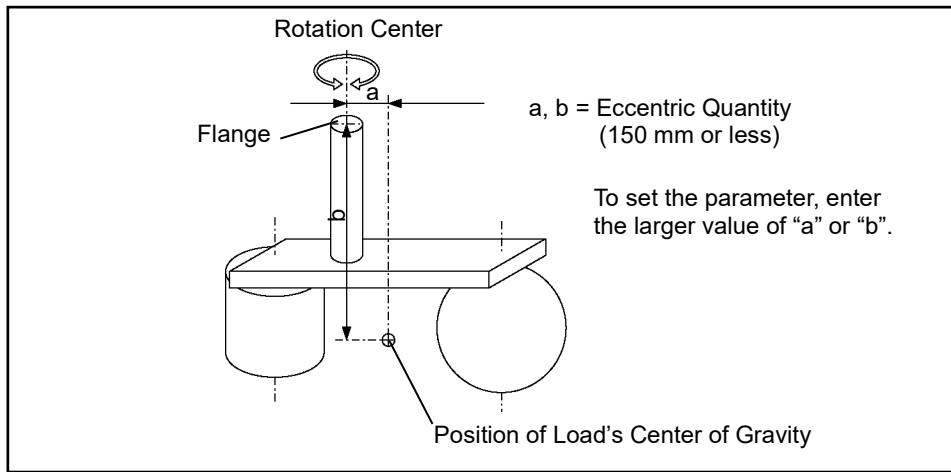

Eccentric Quantity

Eccentric quantity of load on Arm #6

The eccentric quantity of the load (weight of the end effector and work piece) on the Arm #6 can be set by the “eccentric quantity” parameter of the INERTIA command. Enter the larger value of either “a” or “b” in the figure above to [Eccentricity].

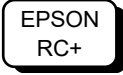

Select [Tools]–[Robot Manager]–[Inertia] panel and enter the value into [Eccentricity:]. You may also execute the Inertia command from [Command Window].

Automatic acceleration/deceleration setting by INERTIA (eccentric quantity)

Automatic setting by inertia moment setting

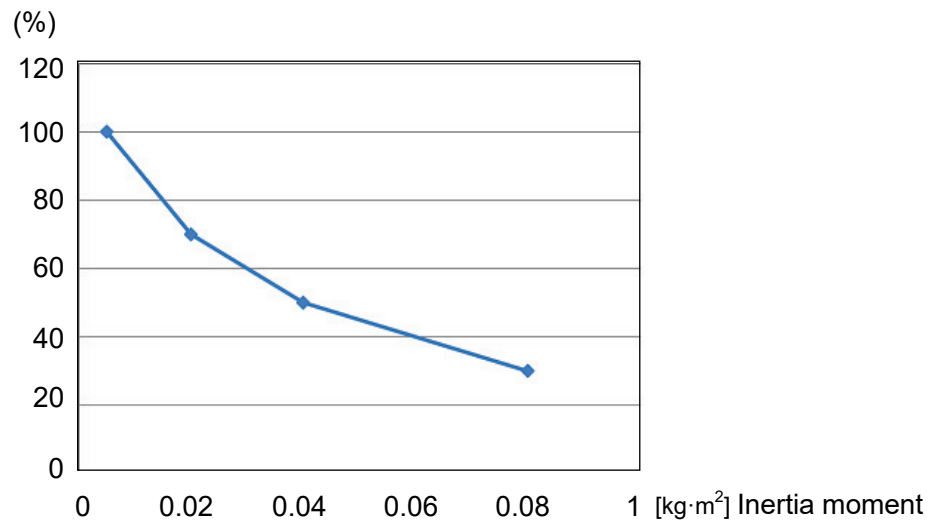

\* The percentage in the graph is based on the acceleration / deceleration at rated eccentricity (0.005 kg·m<sup>2</sup>) as 100%.

Automatic setting by eccentricity setting

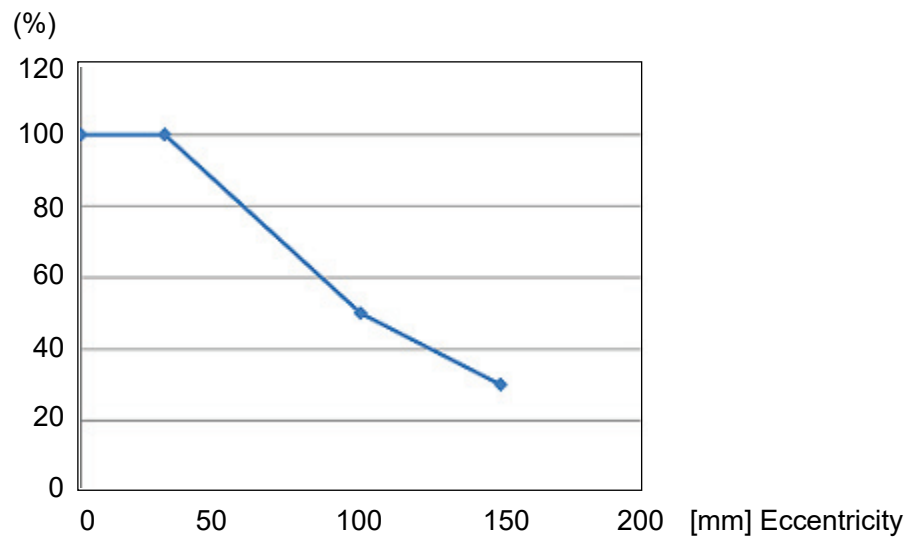

\* The percentage in the graph is based on the acceleration / deceleration at rated eccentricity (30 mm) as 100%.

Calculating the Inertia Moment

Refer to the following example formulas to calculate the inertia moment of the load (end effector with work piece).

The inertia moment of the entire load is calculated by the sum of (a), (b), and (c).

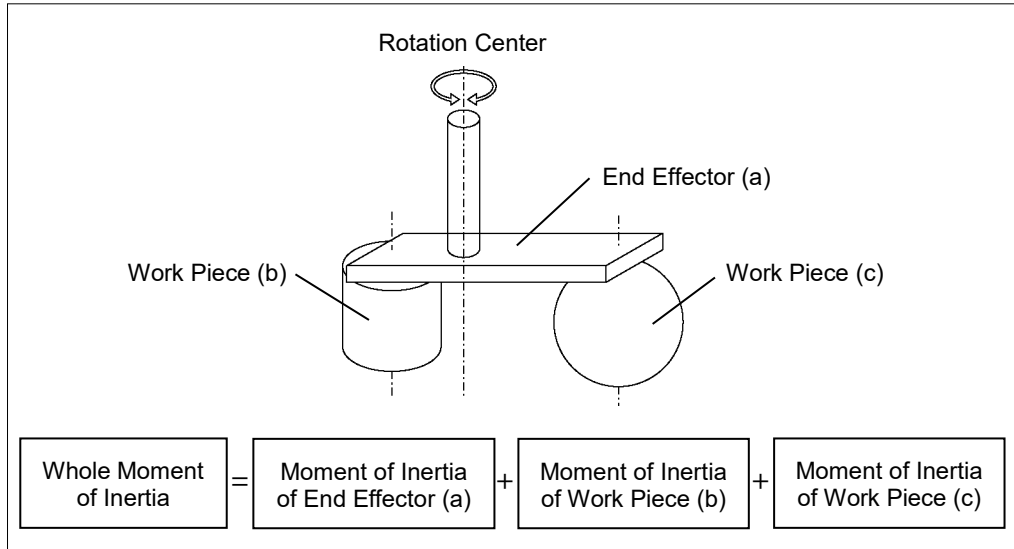

The methods for calculating the inertia moment for (a), (b), and (c) are shown in this and the next page. Figure out the whole inertia moment using the basic formulas below.

(a) Inertia moment of a rectangular parallelepiped

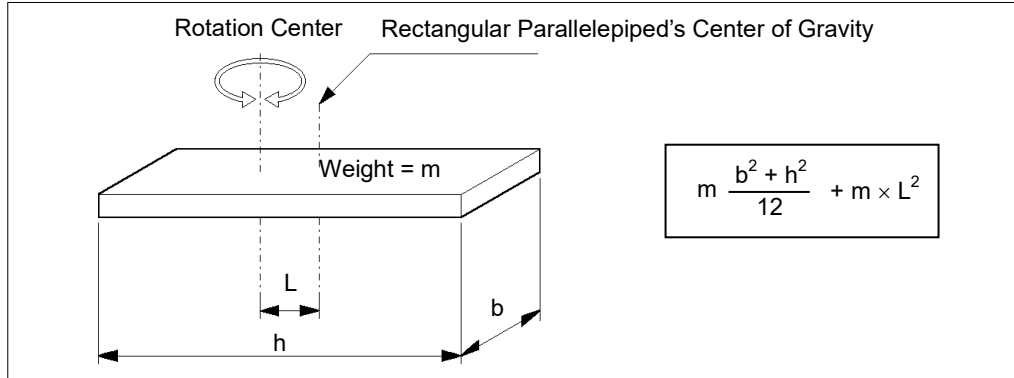

(b) Inertia moment of a cylinder

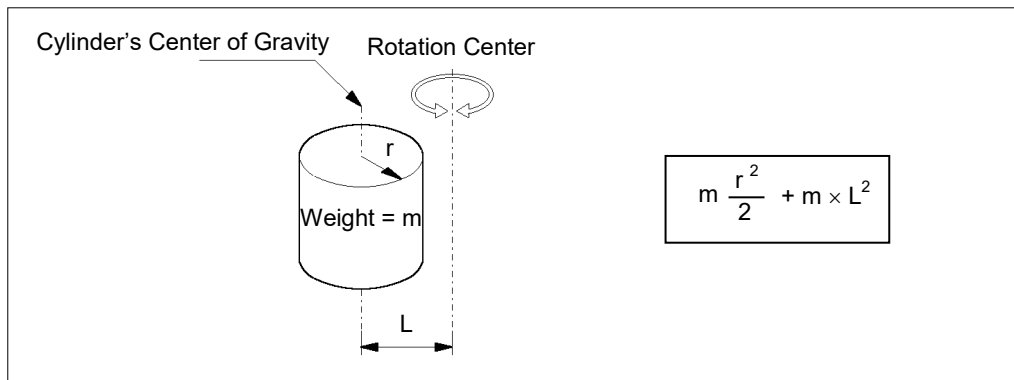



(c) Inertia moment of a sphere

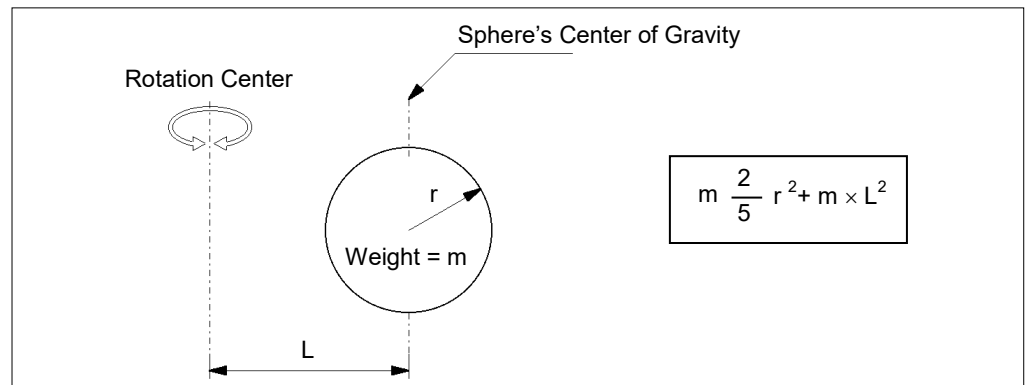

#### 4.4 Precautions for Auto Acceleration/Deceleration

The speed and acceleration/deceleration of the Manipulator motion are automatically optimized according to the values of WEIGHT and INERTIA and the Manipulator's postures.

##### WEIGHT Setting

The speed and acceleration/deceleration of the Manipulator are controlled according to the load weight set by the WEIGHT command.

The more the load weight increases, the more the speed and acceleration/deceleration are reduced to prevent residual vibration.

##### INERTIA Setting

The acceleration/deceleration of Arm #6 are controlled according to the inertia moment set by the INERTIA command. The acceleration/deceleration of the whole Manipulator are controlled according to the eccentricity set by the INERTIA command. The more the inertia moment and eccentricity of the load increase, the more the acceleration/deceleration are reduced.

##### Auto Acceleration/Deceleration According to Manipulator's Posture

The acceleration/deceleration are controlled according to the Manipulator's posture. When the Manipulator extends its arms or when the movement of the Manipulator produces vibration frequently, the acceleration/deceleration are reduced.

Set appropriate values for WEIGHT and INERTIA so that the Manipulator operation is optimized.

## 5. Motion Range



WARNING

- When limiting the motion range for safety, be sure to set by the pulse range. Failure to do so may cause serious safety problems.

The motion range is preset at the factory as describes in the *Setup & Operation 2.5 Standard Motion Range*. This is the maximum motion range of the Manipulator.

Motion range is set by the following two methods:

1. Setting by pulse range (for all arms)
2. Setting the Cartesian (rectangular) range in the X, Y coordinate system of the Manipulator

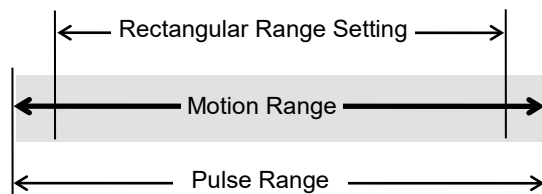

When the motion range is changed due to layout efficiency or safety, follow the descriptions in 5.1 through 5.3 to set the range.

### 5.1 Motion Range Setting by Pulse Range (for Each Joint)

Pulses are the basic unit of Manipulator motion. The motion range of the Manipulator is controlled by the pulse range (the lower limit and the upper limit) of each axis.

Pulse values are read from the encoder output of the servo motor.

The pulse range should be set within the maximum motion range.



NOTE

Once the Manipulator receives an operating command, it checks whether the target position specified by the command is within the pulse range before operating. If the target position is out of the set pulse range, an error occurs and the Manipulator does not move.

EPSON  
RC+

The pulse range can be set in [Tools]-[Robot manager]-[Range] panel. You may also execute the Range command from the [Command Window].

**5.1.1 Max. Pulse Range of Joint #1**

When viewing from above, pulse values in counterclockwise direction are positive (+) and values in clockwise direction are negative (-).

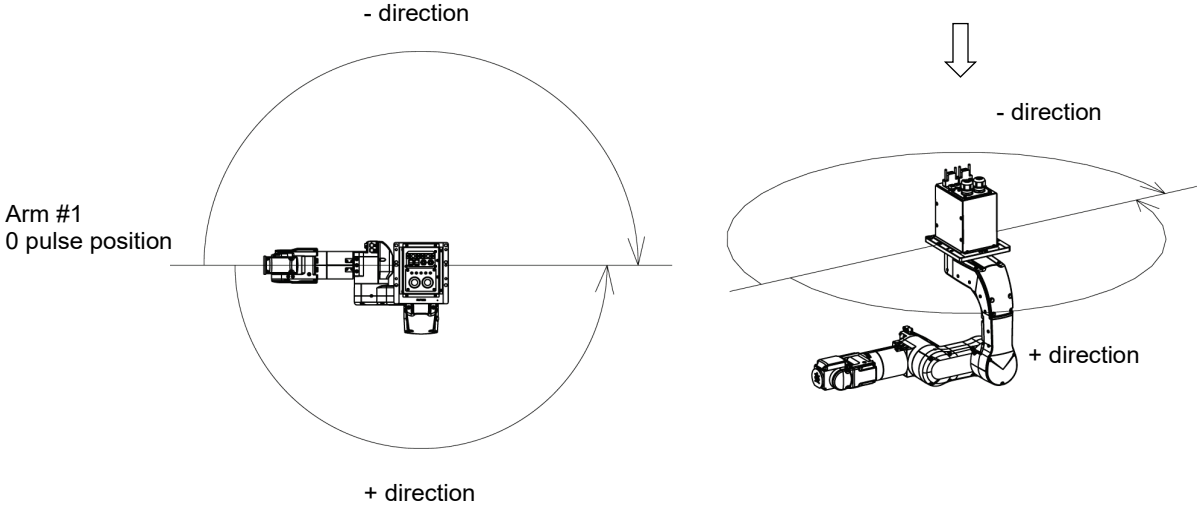

Angle (°) : ±180  
 Pulse (pulse) : ±7929856

**5.1.2 Max. Pulse Range of Joint #2**

When viewing from the outside of the Arm #1, pulse values in counterclockwise direction are positive (+) and values in clockwise direction are negative (-).

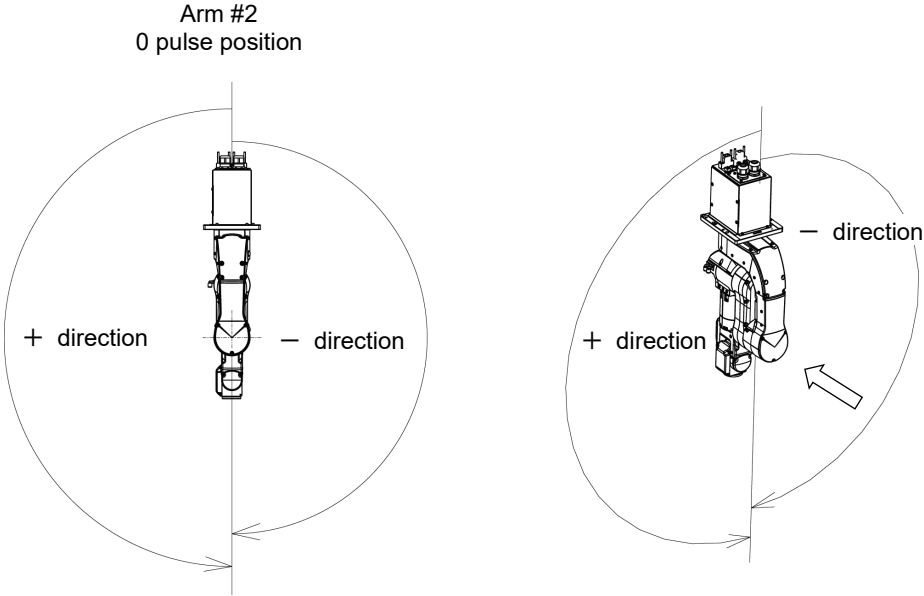

Angle (°) : ±180  
 Pulse (pulse) : ±7929856

### 5.1.3 Max. Pulse Range of Joint #3

When viewing from the outside of the Arm #1, pulse values in counterclockwise direction are positive (+) and values in clockwise direction are negative (-).

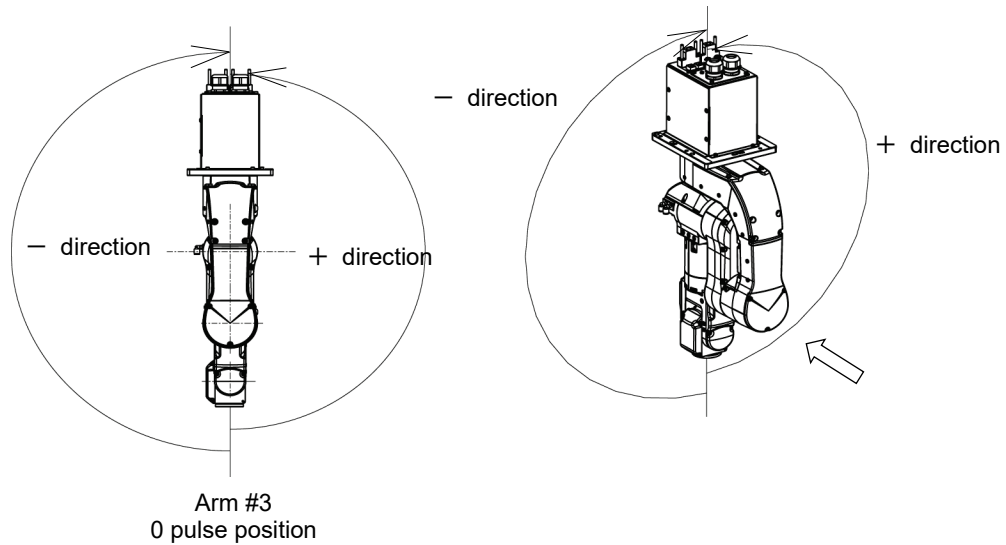

Angle (°) : ±180  
 Pulse (pulse) : ±6619136

### 5.1.4 Max. Pulse Range of Joint #4

From the angle of arm end, clockwise pulse values are positive (+) and counterclockwise pulse values are negative (-).

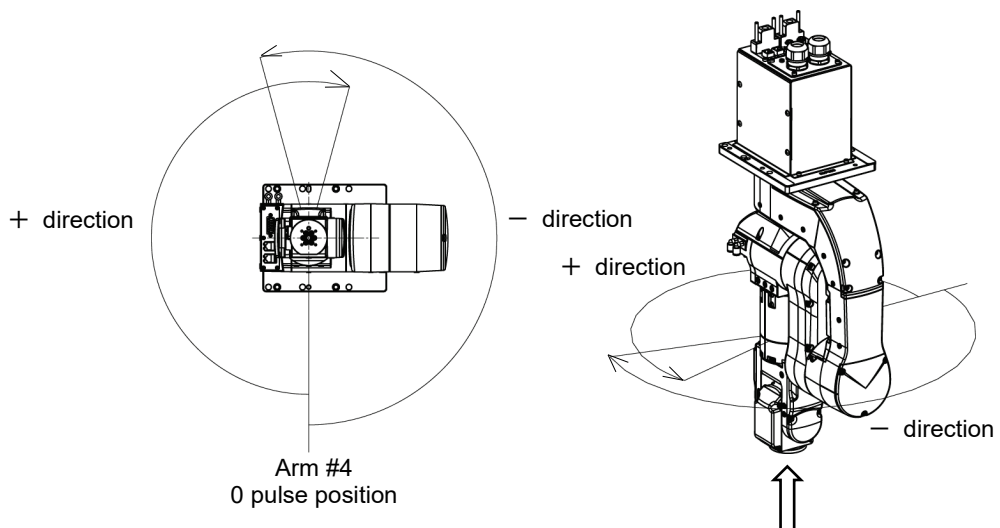

Angle (°) : ±195  
 Pulse (pulse) : ±7170731

**5.1.5 Max. Pulse Range of Joint #5**

When viewing from the outside of the Arm #1, pulse values in counterclockwise direction are positive (+) and values in clockwise direction are negative (-).

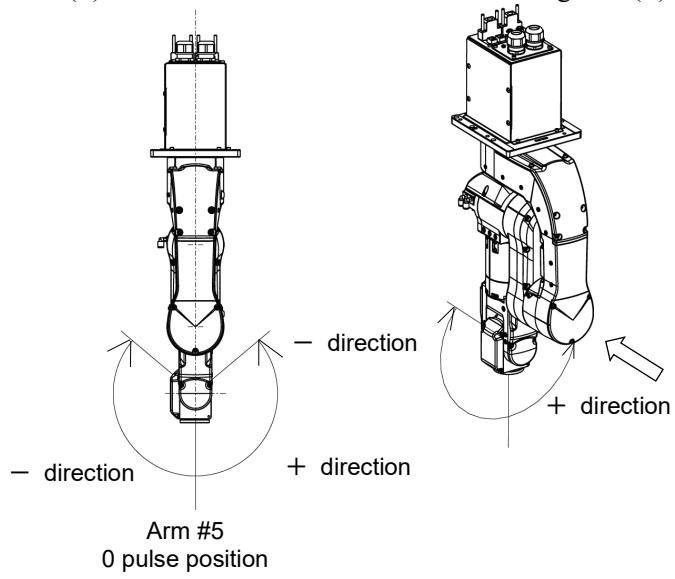

Angle (°) : ±130  
Pulse (pulse) : ± 4733156

**5.1.6 Max. Pulse Range of Joint #6**

From the angle of arm end, clockwise pulse values are positive (+) and counterclockwise pulse values are negative (-).

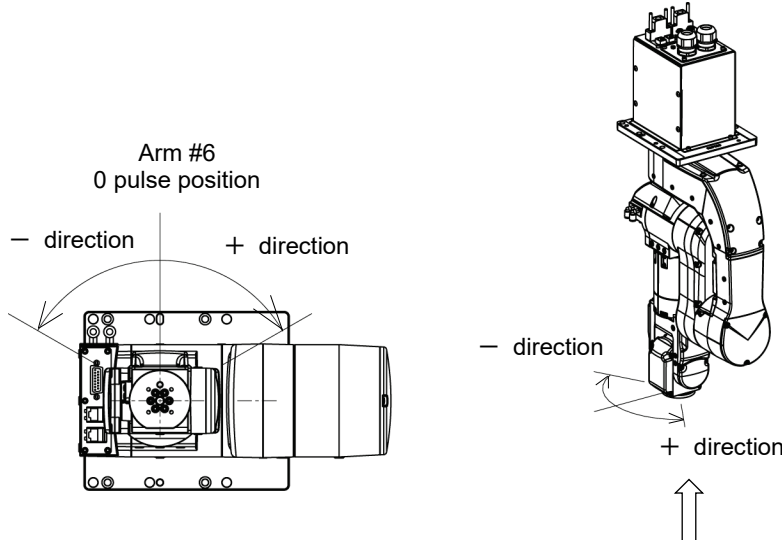

Angle (°) : ±360  
Pulse (pulse) : ±13107200

## 5.2 Restriction of Manipulator Operation

To prevent the arms of the Manipulator from interfering each other, the Manipulator operation is restricted as follows:

### Combination restriction of joint angles

The motion ranges of the Joints #2 and #3 are defined according to the combinations of their angles. If the combination of the joint angles falls the painted areas in the below figure, the Manipulator motion will be restricted.

#### Combination of Joints #2 and #3:

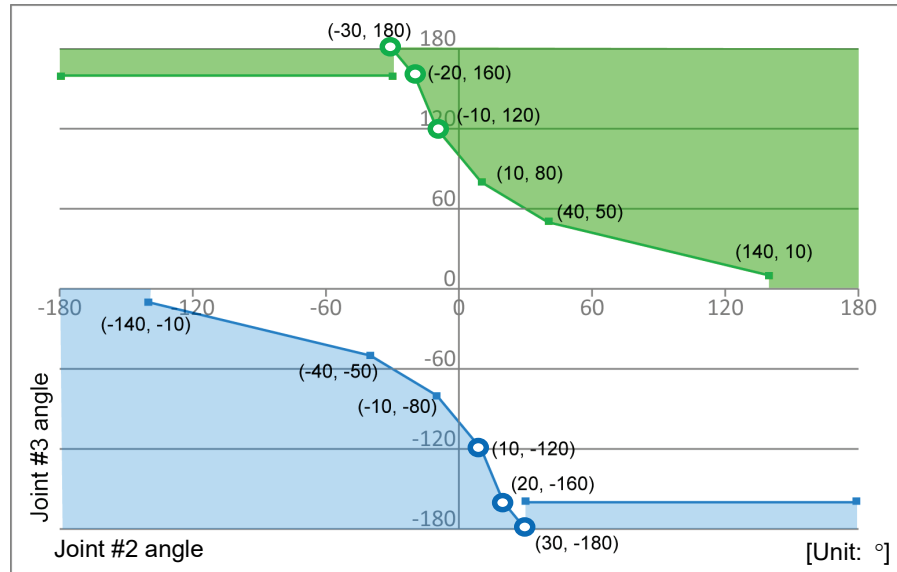

**NOTE**

N2 series Manipulator cannot move to the angles indicated with .

### Restriction of orientation

The Manipulator cannot have the following orientation except in Jog motion.

- When the angles of both Joint #2 and #3 are positive values with Righty, Below Elbow orientation.
- When the angles of both Joint #2 and #3 are negative values with Lefty, Below Elbow orientation.

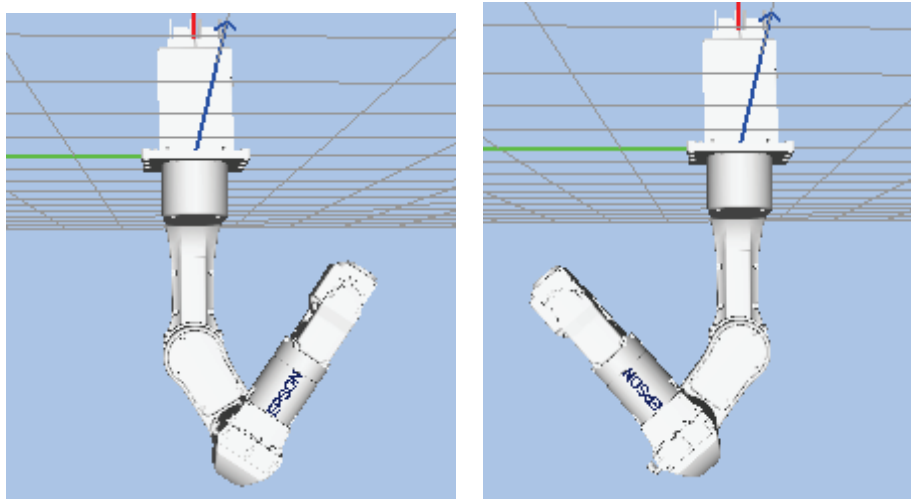

### Restriction area

When the tip of the robot arm is inside the red frame area in the below figure, the Manipulator cannot move to the blue frame area.

Similarly, the Manipulator cannot move to the red frame area when the tip of the arm is in the blue frame area.

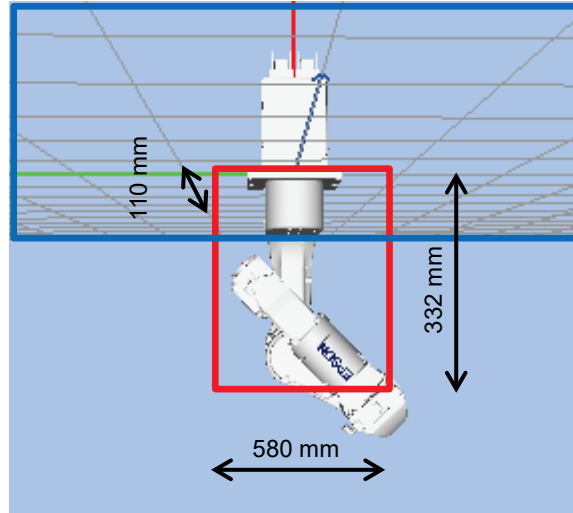

(Red frame: rectangular of 110 mm × 580 mm × 332 mm)

### 5.3 Coordinate System

The origin point is where the Manipulator's installation face intersects with the rotation axis of Joint #1.

For details on the coordinate system, refer to the *EPSON RC+ Users Guide manual*.

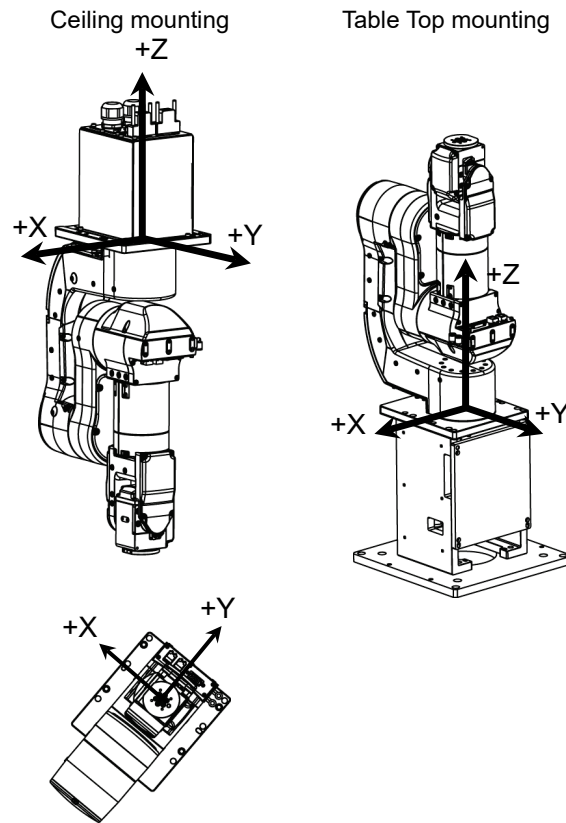

The “Table Top mount bracket” for Table Top mounting is available as an option.

For details, refer to *Setup & Operation 6.6 Table Top Mount Bracket*.



## 5.4 Changing the Robot

This section describes how to change the Manipulator model on EPSON RC+.

(Default setting is “Ceiling mounting”).



CAUTION

- Changing the Manipulator should be done with great caution. It initializes the robot calibration parameters (Hofs, CalPIs), additional axis information, and PG parameter data.

Before changing the robot, make sure to save the calibration data by following the procedure below.

1. Select the EPSON RC+ 7.0 menu-[Setup]-[System Configuration].
2. Select [Robot]-[Robot\*\*]-[Calibration] from the tree list. Then, click <Save>.

(1) Select the EPSON RC+ 7.0 menu-[Setup]-[System Configuration].

(2) Select [Robot]-[Robot\*\*] from the tree list.



(3) Click the <Change...> button. The following dialog box will be displayed.

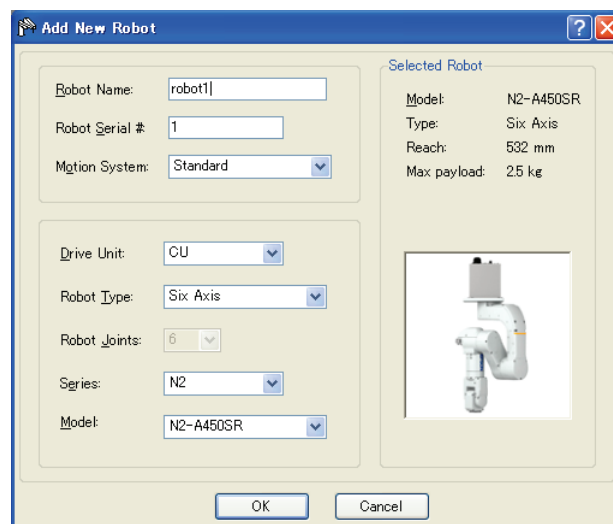

(4) Input the robot name and serial number printed on the name plate of the Manipulator. Any serial number can be entered. However, enter the number printed on the Manipulator.

- (5) Select the robot type in the [Robot type] box.
- (6) Select the series name of the Manipulator in the [Series] box.
- (7) Select the robot model in the [Model] box. Available robots will be displayed according to the format of the currently installed motor driver. When [Dry run] is used, all the Manipulators of the series selected in Step 6 will be displayed.  
(Ceiling mount type: N2-A450SR, table top mount type: N2-A450S)
- (8) Click the <OK> button. The Controller will be restarted.

## 5.5 Setting the Cartesian (Rectangular) Range in the XY Coordinate System of the Manipulator

The Cartesian (rectangular) range in the XY coordinate system of the Manipulator is specified by the limited Manipulator operation area and the XYLim setting.

The limited Manipulator operation area is defined so that the end effector does not interfere with the rear side of the Manipulator. The XYLim setting that you can determine the upper and lower limits of the X and Y coordinates.

The limited Manipulator operation area and the XYLim setting apply only to the software. Therefore, these settings do not change the physical range. The maximum physical range is based on the position of the pulse range.

These settings are disabled during a joint jogging operation. Therefore, be careful not to allow the end effector to collide with the Manipulator or peripheral equipment.

EPSON  
RC+

Set the XYLim setting in [Tools]-[Robot manager]-[XYZ Limits] panel.  
You may also execute the XYLim command from the [Command Window].

## 6. Options

N2 series Manipulator has the following options.

- 6.1 Brake Release Unit
- 6.2 Camera Plate Unit
- 6.3 Tool Adapter (ISO flange)
- 6.4 User Wires
- 6.5 Wiring Guide
- 6.6 Table Top Mount Bracket
- 6.7 Calibration Plate

### 6.1 Brake Release Unit

With the Solenoid brakes are ON (such as in Emergency Stop status), all arms except for the Arm #1 cannot be moved by hand.

You can move the Arms by hand using the brake release unit while the controller power is OFF or right after unpacking.



- When connecting or replacing the brake release unit and the external short connector, turn OFF the power to the Controller and the brake release unit. Connecting and disconnecting the connector while the power is ON may result in electrical shock.



- Normally, release the brake of joints one by one. Take extra care if you need to release the brakes of two or more joints simultaneously. Releasing the brakes of two or more joints simultaneously may cause hands and fingers to be caught and/or equipment damage to or malfunction of the Manipulator as the arms of the Manipulator may move in unexpected directions.
- Be careful of the arm falling when releasing the brake. While the brake is being released, the Manipulator's arm falls by its own weight. The arm falling may cause hands and fingers to be caught and/or may cause equipment damage to or malfunction of the Manipulator.

Width	180 mm
Depth	150 mm
Height	87 mm
Weight (Cables are not included.)	1.7 kg
Cable to the Manipulator	2 m
Power cable length	2 m
Power cable (US)	100 V specification
Power cable (EU)	200 V specification
M/C Short connector	For M/C power cable short-circuit

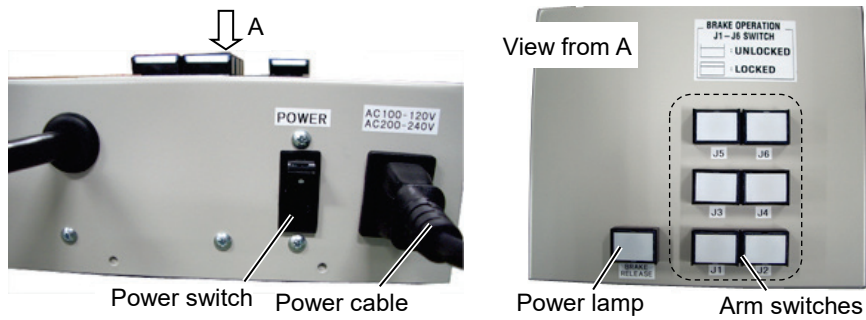

Precautions for use



- If the Manipulator is operated without connecting the brake release unit and the external short connector, the brakes cannot be released and it may cause damage on them. After using the brake release unit, be sure to connect the external short connector to the Manipulator, or check connection of the connector for the brake release unit.
- Keep the external short connector. Otherwise you cannot release the brakes.
- If you turn ON the brake release unit while the brake release switch is being pressed, an unintended arm may move downward. Before turning ON the brake release unit, make sure that the brake release switch is not pressed.
- If you turn ON the brake release unit without the connector, it may lead to the short for the male pin used in the connector. Before turning ON the brake release unit, make sure that the connector is connected.

Mount the brake release unit

- (1) Turn OFF the controller.
- (2) If the M/C power cable is not connected to the Controller:

Connect the M/C short connector,  
or connect the Controller.  
(Keep the Controller power OFF)

The M/C short connector can be purchased singly.

If the M/C power cable is already connected to the Controller:

Go to the step (3).



- (3) Remove the external short connector.

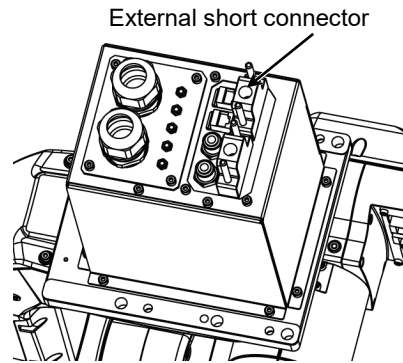

- (4) Connect the brake release unit to the connector of the connection cable.



NOTE The connection cable connector and the adjacent user cable connector have the same shape. Be careful not to connect the wrong connector.

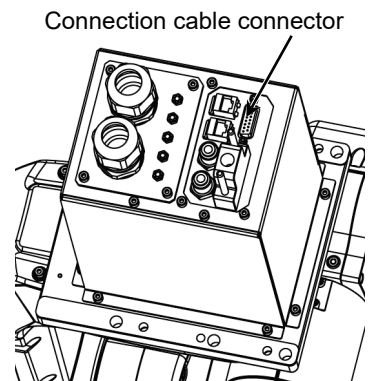

### Remove the brake release unit

- (1) Turn OFF the brake release unit.
- (2) Remove the power cable of the brake release unit.
- (3) Disconnect the brake release unit from the connector of the connection cable.
- (4) If the M/C short connector is connected to the M/C power cable in the Installation step (2), remove the short connector.

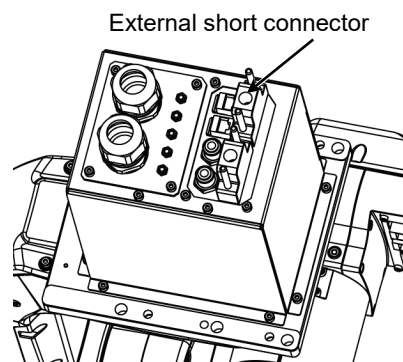

- (5) Connect the external short connector to the connector of the connection cable



NOTE The connection cable connector and the adjacent user cable connector have the same shape. Be careful not to connect the wrong connector.

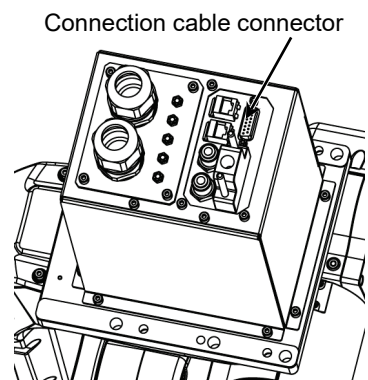

## How to use the brake release unit

 <b>CAUTION</b>	<ul style="list-style-type: none"> <li>■ Be careful of the arm falling when releasing the brake. While the brake is being released, the Manipulator's arm falls by its own weight. The arm falling may cause hands and fingers to be caught and/or may cause equipment damage to or malfunction of the Manipulator.</li> <li>■ If the arm you released its brake moves awkwardly or faster than usual, stop the operation promptly and contact the supplier of your region. The brake release unit may be broken. If you keep operating the Manipulator, it may lead to the breakdown of the Manipulator or you may get your hand or fingers caught.</li> </ul>
---	---

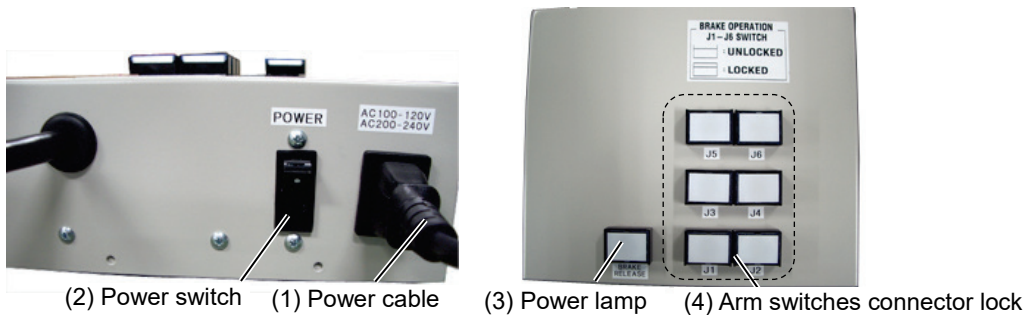

- (1) Plug the power cable into the brake release unit.
- (2) Plug the power cable into the power supply plug.
- (3) Turn ON the brake release unit.  
When the brake release unit is enabled, the power lamp lights up.
- (4) Press the switch of the arm (J2 to J6) you want to move and then move the arm.  
Press the switch again. The brake will be released.  
The brake will be enabled by pressing the switch once again.

**NOTE**  Move the arm the brake is released by two persons or more (one presses the switch and one moves the arm). The arm can be very heavy and needs the significant force to move.

## 6.2 Camera Plate Unit

By using the camera plate unit, you can mount the camera to the N2 series Manipulator.

Appearance of arm end with camera

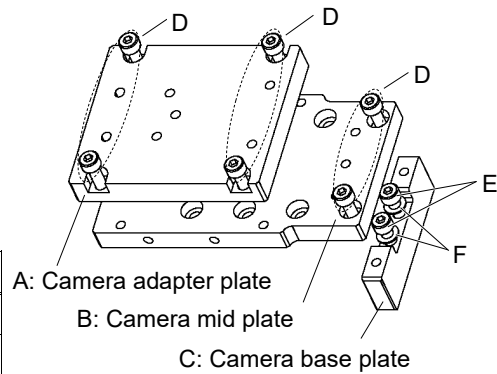
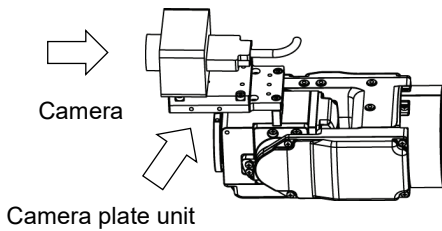

Parts included		unit
A	Camera adapter plate	1
B	Camera mid plate	1
C	Camera base plate	1
D	Hexagon socket head screws M4×12	6
E	Hexagon socket head screws M4×20	2
F	Plain washer for M4 (small washer)	2

### Installation

Mounting holes for the camera base plate on the N2 series Manipulator

Camera base plate mounting hole

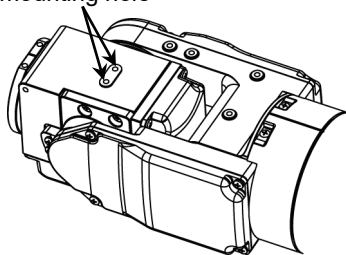

For the installation steps, refer to the following manual:

*EPSON RC+ Option Vision Guide 7.0 Hardware & Setup*  
*Hardware 6.4.1 6-Axis Robot*

Dimension of the camera plate unit

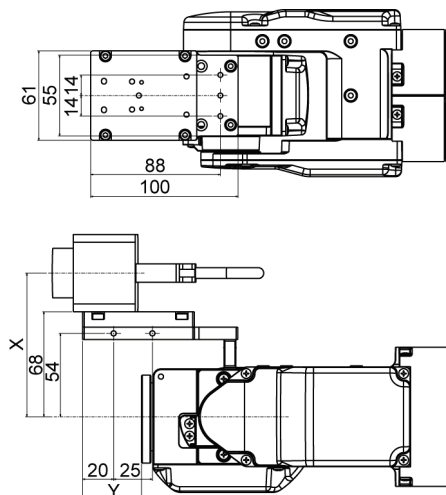



Dimensions X and Y vary depending on the position of the camera mid plate and camera size. Refer to the table below for the values.

**Camera mid plate**

The camera mid plate uses the mounting holes A to D.

By using the different mounting holes, it can be mounted to the camera base plate in the different four positions.

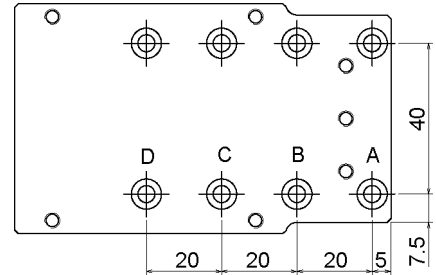

**Camera and N2 series Manipulator Joint #5 motion range (reference values)**

The Joint #5 motion range varies depending on the mounting position of camera mid plate and the camera you are using.

The table below shows the motion range (reference values) based on the available cameras for this option and the mounting positions of the camera mid plate. The values in the table may vary depending on how to secure the cables.

By changing the Y position, you can extend the distance from the end effector mounting surface to the camera. Also, you can attach the larger end effector. However, be careful about the Joint #5 motion range that will be limited in this case.

					(°=degree)
	A	B	C	D	X
USB camera, GigE camera	-135° to +70°	-135° to +53°	-135° to +33°	-135° to +13°	93 mm

	A	B	C	D
Y	38 mm	18 mm	-2 mm	-22 mm

**Direction of the Joint #5 motion**

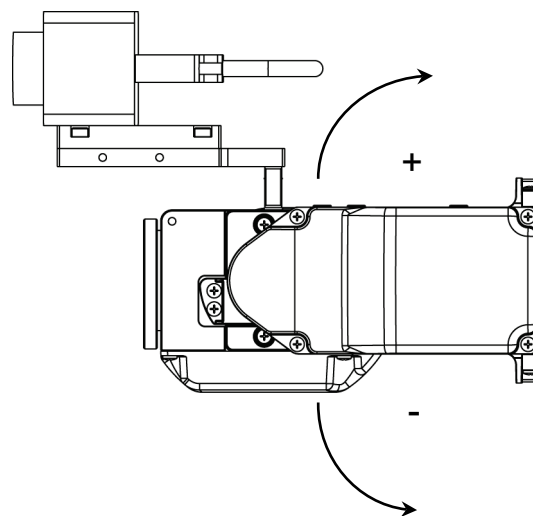

### 6.3 Tool Adapter (ISO Flange)

By using the tool adapter, you can mount the end effector whose dimensions are designed for the ISO flange to the C8 series Manipulators.

Parts included	Unit
ISO flange	1
Pin	1
Hexagon socket head cap bolts M4×12	4

#### Dimensions of ISO flange

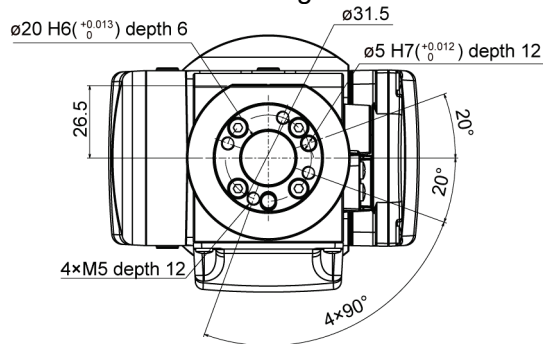

To mount the ISO flange

- (1) Press-fit the pin to the Arm #6 end flange.

Pin projection : 10.5 mm from the flange

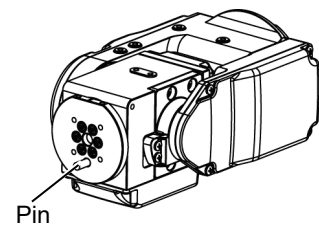

- (2) Align the pin and the pin hole on the flange, and then mount the flange.

Hexagon socket head cap bolts: 4-M4×12

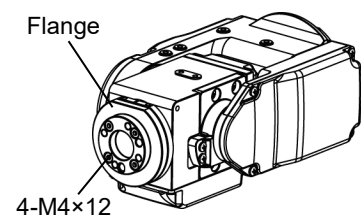

## 6.4 User Wires

Use the following included items when using the internal wiring for the end effector drive.

### Included items

The following parts are attached to the Manipulator as standard.

- Standard fitting for customer use
- Standard user connector kit

#### Standard fittings kit for customer use (ø6 elbow)

Item	Qty.	Manufacturer	Standard
ø6 elbow fitting	2	SMC	KQ2L06-M5N

#### Standard user connector kit (D-sub): Option

Item	Qty.	Manufacturer	Standard
Connector	2	JAE	DA-15PF-N (Solder type)
Clamp hood	2	HRS	HDA-CTH(4-40)(10) (Connector setscrew: #4-40 UNC)

## 6.5 Wiring Guide

This option is used for installing the user wires and tubes.

Use this option to fix the cables and tubes to the end effector when installing the internal wiring and tubing for the end effector drive.

Item	Qty.
Wiring Guide	1
Hexagon socket head cap bolts M4×8	2

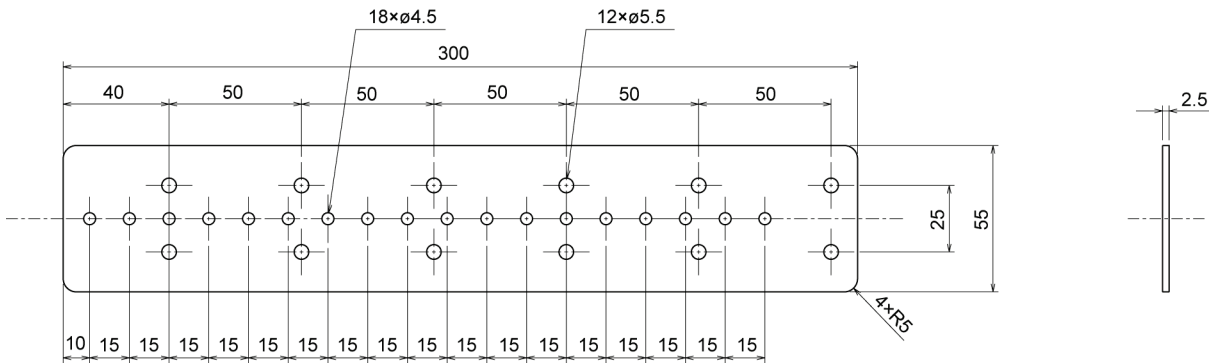

Fix the wiring guide to the Arm with the screws (M4×8). Adjust position up and down according to the marginal length of the cables and tubes.

Fix the cables and tubes along the wiring guide using the wire ties, and then install wiring to the end effector while leaving marginal length.

Installation of Wiring Guide

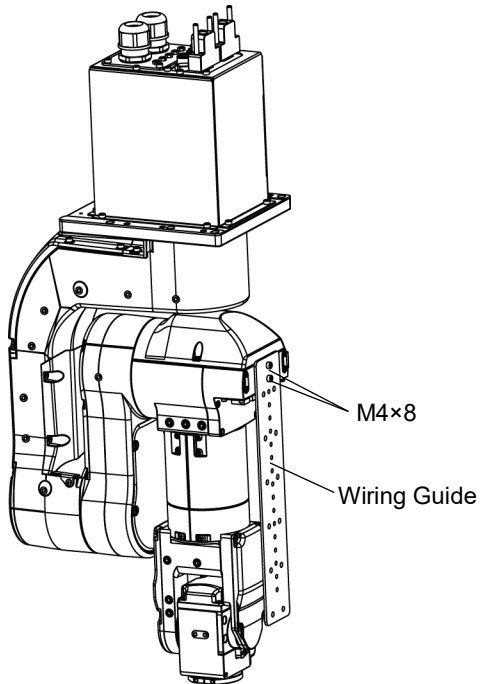

Reference: Example of wiring

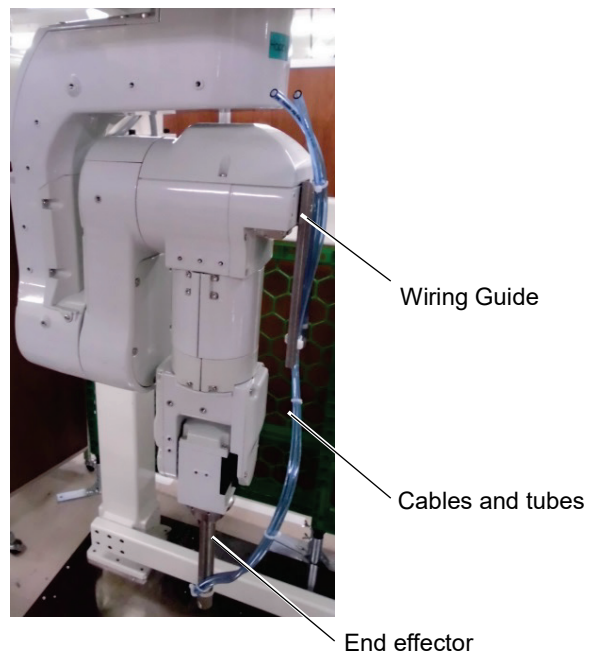

## 6.6 Table Top Mount Bracket

This option is used for installing the Manipulator by table top mounting. The bracket also can be prepared by the customers. The following describes our recommended bracket.



To perform maintenance on the base of table top mounting Manipulator, such as battery replacement, the Manipulator needs to be removed from the table top mount bracket.

Table top Bracket Parts List

Item	Qty.	Material
Table top mount plate 1	1	A5052P
Table top mount plate 2	1	
Table top mount plate 3	1	
Pin ( $\phi 6 \times 15$ )	4	-
Pin ( $\phi 6 \times 25$ )	2	-
Hexagon socket head cap bolts (M4 $\times 15$ )	4	-

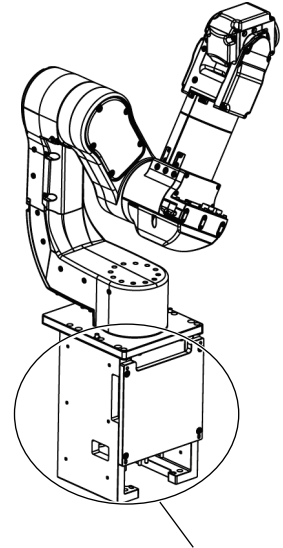
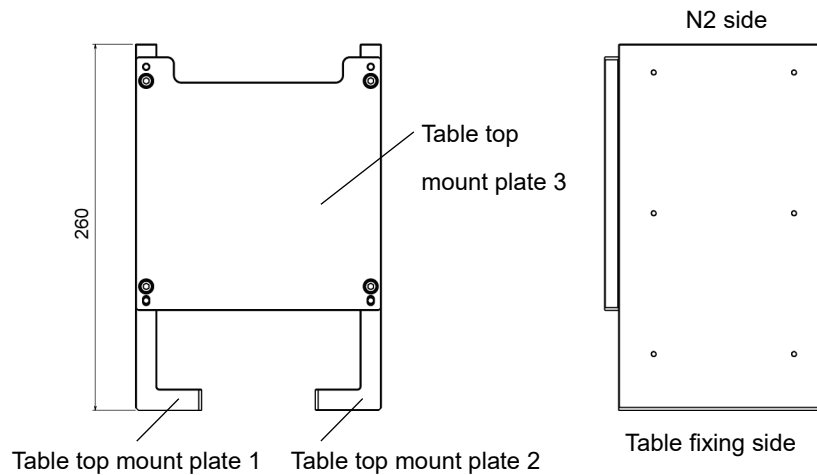
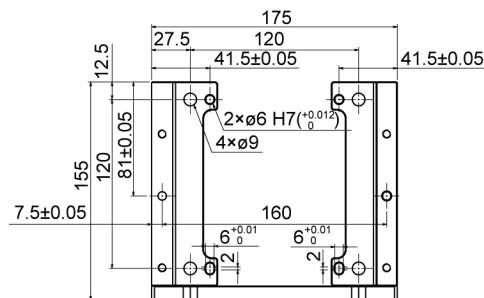

Table Top Mount Bracket

### Rough dimensions



- (1) Assemble the table top mount plates 1, 2, and 3.

Pin ( $\varnothing 4 \times 15$ )

Hexagon socket head cap bolts (M5 $\times$ 15), plain washer for M5

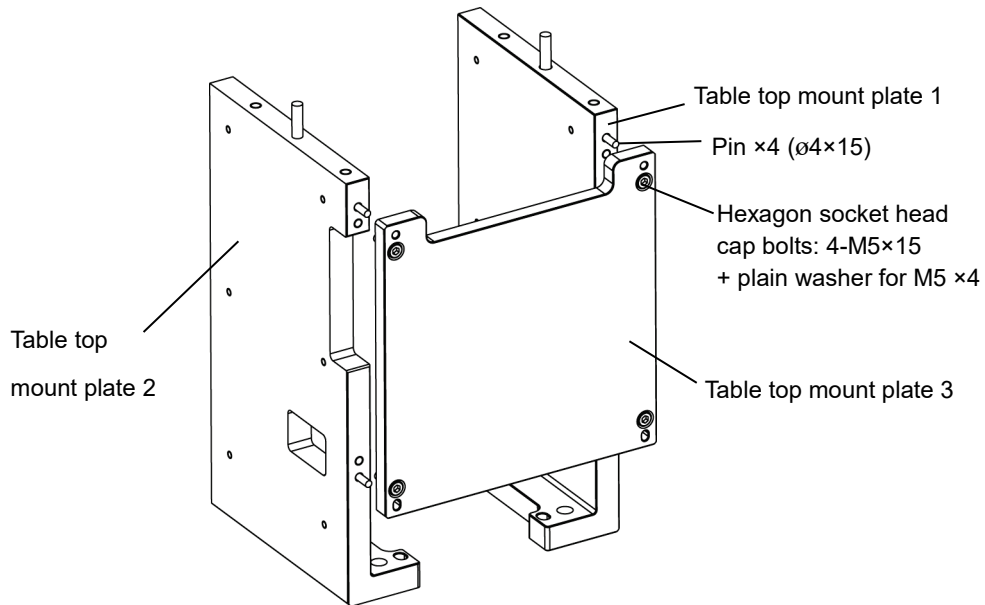

- (2) Fix the bracket to the base table.

Adjust position between the bracket and the table by the table top mount plate 1 or 2.

Fix the table top mount plates 1 and 2 to the table with screws.

Hexagon socket head cap bolts for M8 (4 bolts)

- (3) Fix the Manipulator on the table top mount bracket.

Adjust position between the bracket and the Manipulator by the attached pin ( $\varnothing 6 \times 25$ ).

Fix the bracket and the Manipulator.

Hexagon socket head cap bolts (4-M6 $\times$ 20)

## 6.7 Calibration Plate

This option is used for calibration\*.

### \* Calibration

After parts have been replaced (actuator units, timing belts, etc.), the Manipulator cannot perform positioning properly because a gap exists between the origin stored in each actuator unit and its corresponding origin stored in the Controller.

After replacing the parts, it is necessary to match these origins.

The process of aligning the two origins is called “Calibration”.

There are two methods to perform calibration.

Using the calibration plate

Using the origin position marks (0 pulse position)

Using the calibration plate helps to perform calibration with higher accuracy than calibration using the origin position marks.

For details of calibration, refer to *Maintenance 8. Calibration*.

Calibration Plate Parts List

Item	Qty.
Calibration plate (weight: 2.5 kg)	1
Arm #4 offset jig	1
Arm #6 offset jig	1
Hexagon socket head cap bolts (M4×15)	8
Hexagon socket head cap bolts (M4×20)	4
J1 origin position pin	1
Hexagon socket head cap bolts (M2.5×20)	1
Plain washer for M4 (small washer)	8

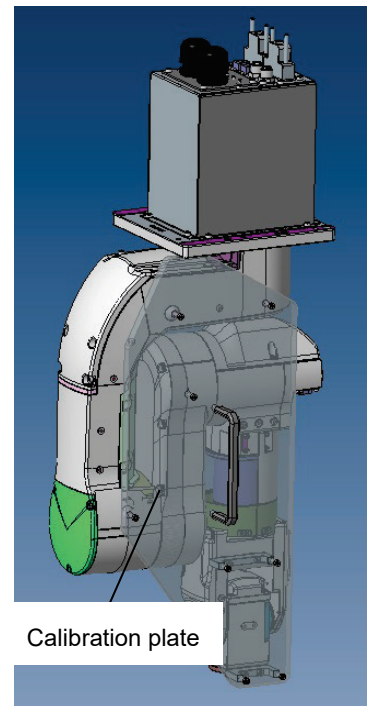





# Maintenance

This volume contains maintenance procedures with safety precautions for the N2 series Manipulators.



# 1. Safety Maintenance

Please read this chapter, this manual, and other relevant manuals carefully to understand safe maintenance procedures before performing any maintenance.

Only authorized personnel who have taken safety training should be allowed to perform the robot maintenance.

Safety training is the program for industrial robot operators to follow the laws and regulations of each nation.

The personnel who have taken safety training acquire knowledge of industrial robots (operations, teaching, etc.), inspections, and related rules/regulations.

The personnel who have completed the robot system-training and maintenance-training held by the manufacturer, dealer, or locally-incorporated company are allowed to perform maintenance.



WARNING

- Do not remove any parts unless otherwise instructed by this manual. Follow the maintenance procedure strictly as described. Improper removal of parts or improper maintenance may cause not only malfunction of the robot system but serious safety problems.
- If you have not received training, keep away from the Manipulator while the power is ON. Do not enter the operating area while the power is ON. Entering the operating area with the power ON is extremely hazardous and may cause serious safety problems as the Manipulator may move even it seems to be stopped.
- When you check the operation of the Manipulator after replacing parts, be sure to check it while you are outside of the safeguarded area. Checking the operation of the Manipulator while you are inside of the safeguarded area may cause serious safety problems as the Manipulator may move unexpectedly.
- Before operating the robot system, make sure that both the Emergency Stop switches and safeguard switch function properly. Operating the robot system when the switches do not function properly is extremely hazardous and may result in serious bodily injury and/or serious damage to the robot system as the switches cannot fulfill their intended functions in an emergency.



WARNING

- To shut off power to the robot system, disconnect the power plug from the power source. Be sure to connect the AC power cable to a power receptacle. DO NOT connect it directly to a factory power source.
- Before performing any replacement procedure, turn OFF the Controller and related equipment, and then disconnect the power plug from the power source. Performing any replacement procedure with the power ON is extremely hazardous and may result in electric shock and/or malfunction of the robot system.
- When connecting or replacing the brake release unit and the external short connector, turn OFF the power to the Controller and the brake release unit. Inserting and removing the connector while the power is ON may result in electrical shock.



CAUTION

- Be sure to connect the cables properly. Do not allow unnecessary strain on the cables. (Do not put heavy objects on the cables. Do not bend or pull the cables forcibly.) It may result in damage to the cables, disconnection, and/or contact failure. These are extremely hazardous and may result in electric shock and/or improper function of the robot system.
- If the Manipulator is operated without connecting the brake release unit and the external short connector, the brakes cannot be released and it may cause damage on them. After using the brake release unit, be sure to connect the external short connector to the Manipulator, or check connection of the connector for the brake release unit.
- The Manipulator arms may become hot after the Manipulator operation due to heat generation of the motors. Be careful when performing maintenance.

## 2. General Maintenance

This chapter describes maintenance inspection procedures. Performing maintenance inspection properly is essential to prevent trouble and ensure safety.

Be sure to perform the maintenance inspections in accordance with the schedule.

### 2.1 Maintenance Inspection

#### 2.1.1 Schedule for Maintenance Inspection

Inspection points are divided into five stages: daily, monthly, quarterly, biannual, and annual. The inspection points are added every stage.

If the Manipulator is operated for 250 hours or longer per month, the inspection points must be added every 250 hours, 750 hours, 1500 hours, and 3000 hours operation.

	Inspection Point					
	Daily inspection	Monthly inspection	Quarterly inspection	Biannual inspection	Annual inspection	Overhaul*
1 month (250 h)	Inspect every day	√				
2 months (500 h)		√				
3 months (750 h)		√	√			
4 months (1000 h)		√				
5 months (1250 h)		√				
6 months (1500 h)		√	√	√		
7 months (1750 h)		√				
8 months (2000 h)		√				
9 months (2250 h)		√	√			
10 months (2500 h)		√				
11 months (2750 h)		√				
12 months (3000 h)		√	√	√	√	
13 months (3250 h)		√				
⋮	⋮	⋮	⋮	⋮	⋮	⋮
20000 h						√

h = hour

\*Overhaul (parts replacement)

2.1.2 Inspection Point

Inspection While the Power is OFF (Manipulator is not operating)

Inspection Point	Inspection Place	Daily	Monthly	Quarterly	Biannual	Annual
Check looseness or backlash of bolts/screws. Tighten them if necessary. (For the tightening torque, refer to <i>Maintenance: 2.4 Tightening Hexagon Socket Head Cap Bolts.</i> )	End effector mounting bolts	√	√	√	√	√
	Manipulator mounting bolts	√	√	√	√	√
	Each arm locking bolts	√	√	√	√	√
	Bolts/screws around shaft					√
	Bolts/screws securing motors, reduction gear units, etc.					√
Check looseness of connectors. If the connectors are loosen, push it securely or tighten.	External connectors on Manipulator (on the connector plates etc.)	√	√	√	√	√
	Manipulator cable unit		√	√	√	√
Visually check for external defects. Clean up if necessary.	External appearance of Manipulator	√	√	√	√	√
	External cables		√	√	√	√
Check the leak of grease for cables.	Refer to <i>Maintenance: 4.1 Installation: Cable Unit (60)</i>	√	√			
Check for bends or improper location. Repair or place it properly if necessary.	Safeguard etc.	√	√	√	√	√
Check tension of timing belts. Tighten it if necessary.	Inside of Arms #4				√	√
Grease conditions	Refer to <i>Maintenance: 2.3 Greasing.</i>					
Battery	Refer to <i>Maintenance: 6. Battery.</i>					
Check either the external short connector or the brake release unit connector is connected.	The external short connector on the back side of the Manipulator, or the brake release unit connector.	√	√	√	√	√

Inspection While the Power is ON (Manipulator is operating)

Inspection Point	Inspection Place	Daily	Monthly	Quarterly	Biannual	Annual
Check motion range	Each joint					√
Move the cables back and forth lightly to check whether the cables are disconnected.	External cables				√	√
Push each arm in MOTOR ON status to check whether backlash exists.	Each arm					√
Check whether unusual sound or vibration occurs.	Whole	√	√	√	√	√
Measure the accuracy repeatedly by a dial gauge.	Whole					√
<p>When brake release unit is installed:                      Connect the brake release unit and check the sound of the Solenoid brake with the brake released.                      If there is no sound, replace the actuator unit.</p> <p>When brake release unit is not installed:                      Execute Brake off command (brake off, joint #) from the command window of the EPSON RC+ while the motors are OFF, and then check the sound of the Solenoid brake. If there is no sound, replace the actuator unit.</p> <p>Note: The Joint #1 is not equipped with the brake.                      The Joints #2 to #6 have the brakes.</p>	Brake	√	√	√	√	√

## 2.2 Overhaul (Parts Replacement)



- Overhaul timing is based on an assumption that all joints are operated for equal distance. If a particular joint has a high duty or high load, it is recommended to overhaul all joints (as many as possible) before exceeding 20,000 operation hours with the joint as a basis.

The parts for the Manipulator joints may cause accuracy decline or malfunction due to deterioration of the Manipulator resulting from long term use. In order to use the Manipulator for a long term, it is recommended to overhaul the parts (parts replacement).

The time between overhauls is 20,000 operation hours of the Manipulator as a rough indication.

However, it may vary depending on usage condition and degree of the load (such as when operated with the maximum motion speed and maximum acceleration / deceleration in continuous operation) applied on the Manipulator.



For the EPSON RC+ 7.0 Ver. 7.2.x or later (firmware Ver.7.2.x.x or later), the recommended replacement time for the parts subject to maintenance (motors, reduction gear units, and timing belts) can be checked in the [Maintenance] dialog box of the EPSON RC+ 7.0.

For details, refer to the following manual.

*Robot Controller RC700 / RC700-A Maintenance 6. Alarm*

Note:

The recommended replacement time for the maintenance parts is when it reaches the L10 life (time until 10% failure probability). In the [Maintenance] dialog box, the L10 life is displayed as 100%.



The Manipulator operation hours can be checked in [Controller Status Viewer] dialog box -[Motor On Hours].

- (1) Select EPSON RC+ menu-[Tools]-[Controller] to open the [Controller Tools] dialog box.
- (2) Click the <View Controller Status> button to open the [Browse For Folder] dialog box.
- (3) Select the folder where the information is stored.
- (4) Click <OK> to view the [Controller Status Viewer] dialog box.
- (5) Select [Robot] from the tree menu on the left side.

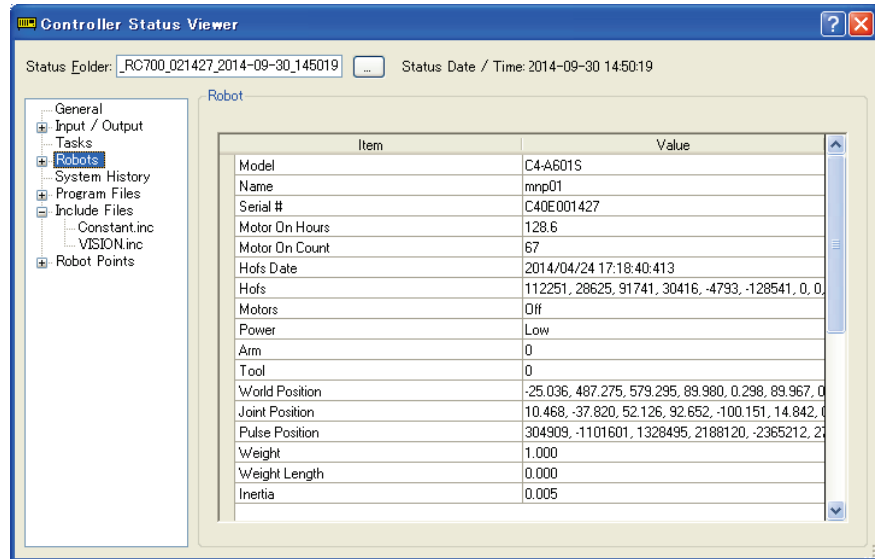

For the parts subject to overhaul, refer to *Maintenance 9. Maintenance Parts List*.

For details of replacement of each part, refer to the *Maintenance* section.

Please contact the supplier of your region for further information.

## 2.3 Greasing

The actuator units and reduction gear units need greasing regularly. Only use the grease specified in the following table.

For the greasing procedure, please contact the supplier of your region.

 WARNING	<ul style="list-style-type: none"> <li>Before greasing, turn OFF the Controller and related equipment, and then disconnect the power plug from the power source. Performing any replacement procedure with the power ON is extremely hazardous and may result in electric shock and/or malfunction of the robot system.</li> </ul>
--	--

 CAUTION	<ul style="list-style-type: none"> <li>Keep enough grease in the Manipulator. Operating the Manipulator with insufficient grease will cause the noise or damage sliding parts and/or result in insufficient function of the Manipulator. Once the parts are damaged, a lot of time and money will be required for the repairs.</li> <li>If grease gets into your eyes, mouth, or on your skin, follow the instructions below.                     <ul style="list-style-type: none"> <li>If grease gets into your eyes: Flush them thoroughly with clean water, and then see a doctor immediately.</li> <li>If grease gets into your mouth: If swallowed, do not induce vomiting. See a doctor immediately. If grease just gets into your mouth, wash out your mouth with water thoroughly.</li> <li>If grease gets on your skin: Wash the area thoroughly with soap and water.</li> </ul> </li> </ul>
--	--

	Part	Interval	Grease
Joint #1, 2, 3	Actuator unit,	Overhaul timing	SK-1A
Joint #4, 5, 6	Reduction gear unit		SK-2

As a rough indication, perform greasing at the same timing as overhaul. However, it may vary depending on usage condition and degree of the load (such as when operated with the maximum motion speed and maximum acceleration / deceleration in continuous operation) applied on the Manipulator.

## 2.4 Tightening Hexagon Socket Head Bolts

Hexagon socket head cap bolts (hereinafter, “bolts”) are used in places where mechanical strength is required. These bolts are fastened with the tightening torque shown in the following tables.

When it is required to refasten the bolts in some procedures in this manual (except special cases as noted), use a torque wrench so that the bolts are fastened with appropriate tightening torque as shown below.

Bolt	Tightening Torque
M2.5	1.4 ± 0.1 N·m (14 ± 1 kgf·cm)
M3	2.0 ± 0.1 N·m (21 ± 1 kgf·cm)
M4	4.0 ± 0.2 N·m (41 ± 2 kgf·cm)
M5	8.0 ± 0.4 N·m (82 ± 4 kgf·cm)
M6	13.0 ± 0.6 N·m (133 ± 6 kgf·cm)
M8	32.0 ± 1.6 N·m (326 ± 16 kgf·cm)
M10	58.0 ± 2.9 N·m (590 ± 30 kgf·cm)
M12	100.0 ± 5.0 N·m (1,020 ± 51 kgf·cm)

See below for the set screw.

Set Screw	Tightening Torque
M3	0.9 ± 0.1 N·m (9 ± 1 kgf·cm)
M4	2.4 ± 0.1 N·m (26 ± 1 kgf·cm)
M5	3.9 ± 0.2 N·m (40 ± 2 kgf·cm)
M6	8.0 ± 0.4 N·m (82 ± 4 kgf·cm)

It is recommended to fasten the bolts aligned on a circumference in a crisscross pattern as shown in the figure below.

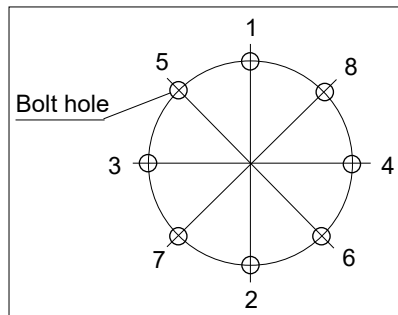

Do not fasten all bolts securely at one time. Divide the number of times to fasten the bolts into two or three and fasten the bolts securely with a hexagonal wrench. Then, use a torque wrench to fasten the bolts with tightening torques shown in the table above.

2.5 Layout of Maintenance Parts

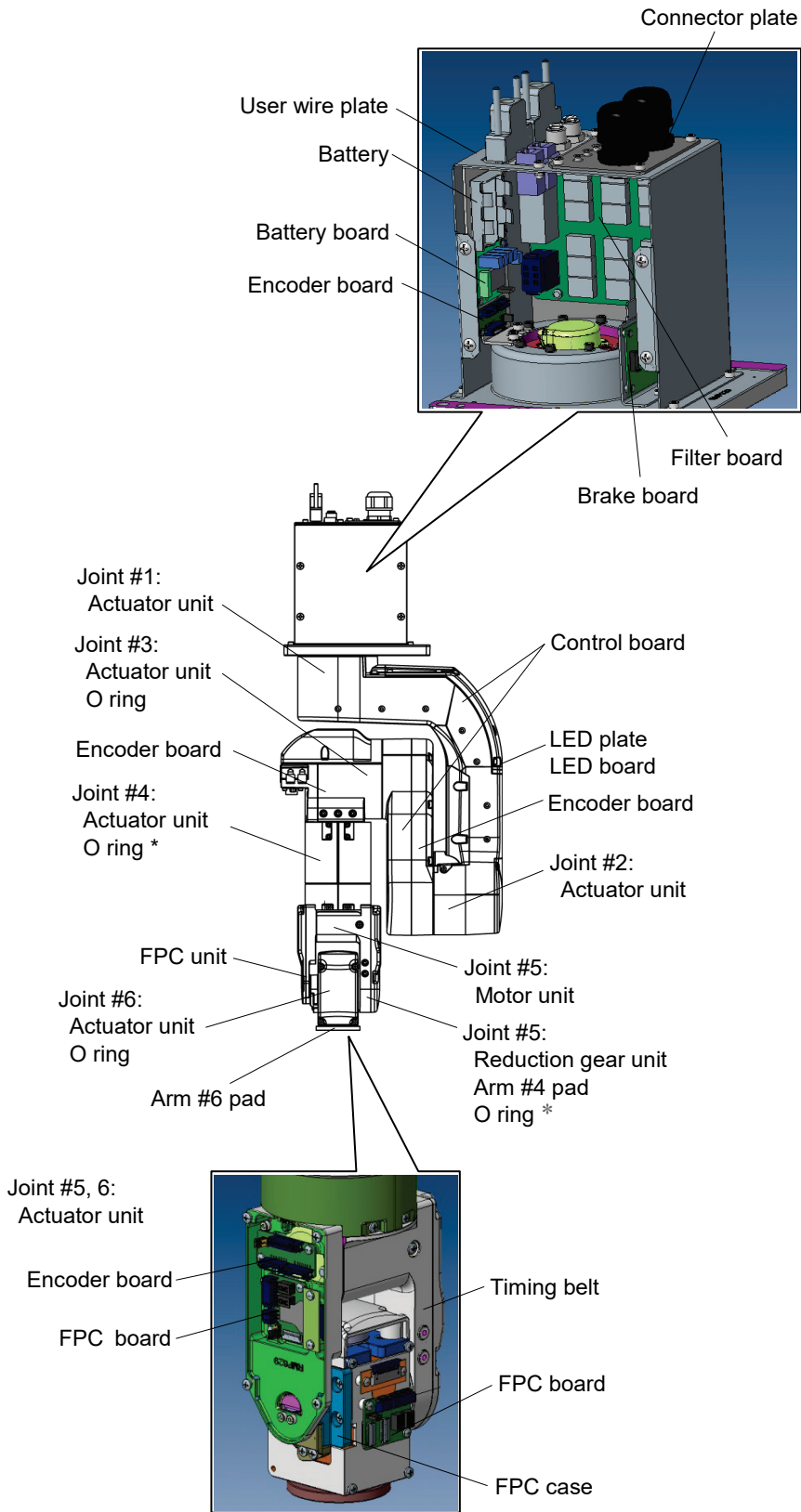

\* : Joint #4 and #5 O rings are common.

## 3. Covers

This chapter describes removal and installation steps of the covers necessary for maintenance.



- Do not connect or disconnect the motor connectors while the power to the robot system is turned ON. Connecting or disconnecting the motor connectors with the power ON is extremely hazardous and may result in serious bodily injury as the Manipulator may move abnormally, and also may result in electric shock and/or malfunction of the robot system.
- To shut off power to the robot system, disconnect the power plug from the power source. Be sure to connect the AC power cable to a power receptacle. DO NOT connect it directly to a factory power source.
- Before performing any replacement procedure, turn OFF the Controller and related equipment, and then disconnect the power plug from the power source. Performing any replacement procedure with the power ON is extremely hazardous and may result in electric shock and/or malfunction of the robot system.
- Be careful not to get any foreign substances in the Manipulator, connectors, and pins during maintenance. Turning ON the power to the robot system when any foreign substances exist in them is extremely hazardous and may result in electric shock and/or malfunction of the robot system.

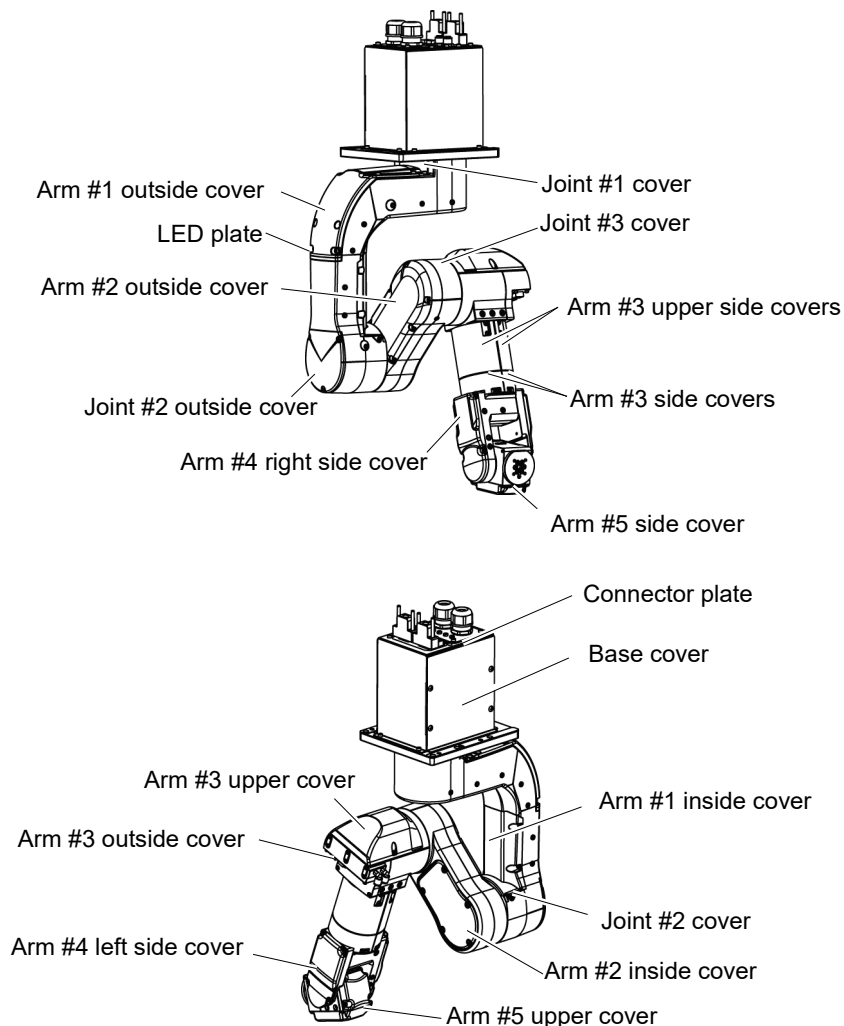

	Name		Qty.	Note	
Maintenance parts	Cover	Arm #1	Joint #1 cover	1	1685530
			Joint #2 cover	1	1685531
			Arm #1 inside cover	1	1696705
			Joint #2 outside cover	1	1685538
			LED plate	1	1685535
		Arm #2	Arm #2 inside cover	1	1685539
			Arm #2 outside cover	1	1696706
			Joint #3 cover	1	1685540
		Arm #3	Arm #3 upper cover	1	1696707
			Arm #3 side cove	2	1696708
		Arm #4	Arm #4 right side cover	1	1685545
			Arm #4 left side cover	1	1696709
		Arm #5	Arm #5 side cover	1	1696710
			Arm #5 upper cover	1	1685547
Tools	Hexagonal wrench		width across flats: 2.5 mm	1	For M3 hexagon socket head cap bolts
			width across flats: 3 mm	1	For M4 hexagon socket head cap bolts
	Cross-point screwdriver (#2)			1	For cross recessed screws

\* To remove the Arm #1 outside cover and the Joint #1 cover, a short head hexagonal wrench as shown below is necessary.

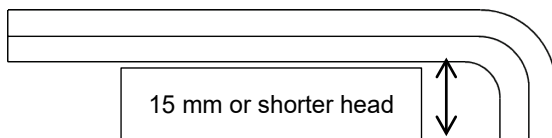

### 3.1 Arm #1 Outside Cover



- When installing the cover, be careful not to get the cables caught in it or bend them forcibly to push into the cover. Unnecessary strain on cables may result in damage to the cables, disconnection, and/or contact failure. These are extremely hazardous and may result in electric shock and/or improper function of the robot system. When routing the cables, check the cable locations at removing the cover. Be sure to place the cables back to their original locations.

#### Removal

- Remove the bolts and then remove the Arm #1 outside cover.

Hexagon socket head cap bolts with captive washer:

4-M4×12 (upper)

4-M4×12 (side)

- NOTE**  Use a short head hexagonal wrench when removing the bolts with the base plate installed.



- Remove the LED board connector.

- NOTE**  The cable is connected to the inside of the Arm #1 outside cover. When removing the cover, be careful not to pull the cable forcibly.

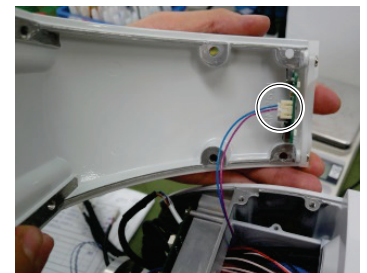

Installation (1) Connect the connector to the LED board.

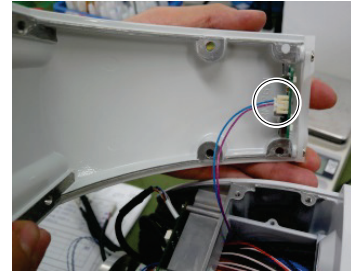

(2) Install the Arm #1 outside cover.

Hexagon socket head cap bolts with captive washer: 8-M4×12

Tightening torque:  $4 \pm 0.2 \text{ N}\cdot\text{m}$



**NOTE** Be careful not to get the cables caught in the cover.

Use a short head hexagonal wrench when fixing the bolts with the base plate installed.





## 3.2 Joint #1 Cover



- When installing the cover, be careful not to get the cables caught in it or bend them forcibly to push into the cover. Unnecessary strain on cables may result in damage to the cables, disconnection, and/or contact failure. These are extremely hazardous and may result in electric shock and/or improper function of the robot system. When routing the cables, check the cable locations at removing the cover. Be sure to place the cables back to their original locations.

### Removal

- (1) Remove the Arm #1 outside cover.

For details, refer to *Maintenance 3.1 Arm #1 Outside Cover*.

- (2) Remove the bolts, and then remove the Joint #1 cover.

**NOTE**  Use a short head hexagonal wrench when removing the bolts with the base plate installed.



### Installation

- (1) Install the Joint #1 cover to the Manipulator.

Tightening torque:  $0.6 \pm 0.05 \text{ N}\cdot\text{m}$

Hexagon socket head cap bolts with captive washer: 2-M4×12

**NOTE**  The cover may get broken if it is fastened too tight. Be careful not to exceed the above tightening torque.

Use a short head hexagonal wrench when fixing the bolts with the base plate installed.

- (2) Install the Arm #1 outside cover.

For details, refer to *Maintenance 3.1 Arm #1 Outside Cover*.

### 3.3 Arm #1 Inside Cover, Joint #2 Cover

 <b>CAUTION</b>	<ul style="list-style-type: none"> <li>When installing the cover, be careful not to get the cables caught in it or bend them forcibly to push into the cover. Unnecessary strain on cables may result in damage to the cables, disconnection, and/or contact failure. These are extremely hazardous and may result in electric shock and/or improper function of the robot system. When routing the cables, check the cable locations at removing the cover. Be sure to place the cables back to their original locations.</li> </ul>
---	---

If it is difficult to remove the cover, change the Manipulator posture by following the steps below.

- (1) Turn on the Controller.
- (2) Release the Joint #2 brake.
 

EPSON  
RC+

 Command > brake off, 2
- (3) Turn the Arm #2 about 90 degrees so that the screws of the Arm #1 inside cover can be seen from above.
- (4) Turn off the Controller.



**Removal**

Remove all screws of the Arm #1 inside cover and the Joint #2 cover.  
 Remove the Joint #2 cover and the Arm #1 inside cover, in that order.

Joint #2 cover

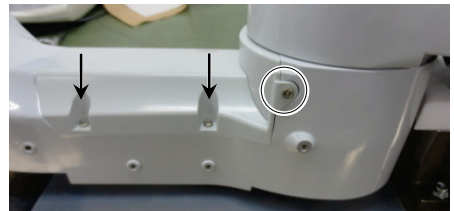

Cross recessed binding head machine screw: 2-M3×6

Arm #1 inside cover

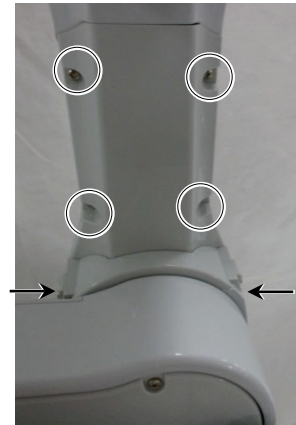

Cross recessed binding head machine screw: 4-M3×6

**Installation**

Attach the Arm #1 inside cover and the Joint #2 cover in that order to the Manipulator, and then fix them with the screws.

Tightening torque:  $0.45 \pm 0.05 \text{ N}\cdot\text{m}$



The cover may get broken if it is fastened too tight. Be careful not to exceed the above tightening torque.

### 3.4 Joint #2 Outside Cover

 <b>CAUTION</b>	<ul style="list-style-type: none"> <li>■ When installing the cover, be careful not to get the cables caught in it or bend them forcibly to push into the cover. Unnecessary strain on cables may result in damage to the cables, disconnection, and/or contact failure. These are extremely hazardous and may result in electric shock and/or improper function of the robot system. When routing the cables, check the cable locations at removing the cover. Be sure to place the cables back to their original locations.</li> </ul>
---	---

**Removal**      Remove the screws, and then remove the Joint #2 outside cover.

**Installation**      Install the Joint #2 outside cover to the Manipulator.  
                                  Tightening torque:  $0.45 \pm 0.05 \text{ N}\cdot\text{m}$

**NOTE**  The cover may get broken if it is fastened too tight. Be careful not to exceed the above tightening torque.



Cross recessed binding head machine screw: 3-M3×6

### 3.5 Arm #2 Outside Cover

 CAUTION	<ul style="list-style-type: none"> <li>When installing the cover, be careful not to get the cables caught in it or bend them forcibly to push into the cover. Unnecessary strain on cables may result in damage to the cables, disconnection, and/or contact failure. These are extremely hazardous and may result in electric shock and/or improper function of the robot system. When routing the cables, check the cable locations at removing the cover. Be sure to place the cables back to their original locations.</li> </ul>
--	---

If it is difficult to remove the cover, change the Manipulator posture by following the steps below.

- (1) Turn on the Controller.
- (2) Release the Joint #2 brake.
 

EPSON RC+	Command > brake off, 2
--------------	---------------------------
- (3) Turn the Arm #2 about 90 degrees so that the screws of the Arm #2 outside cover can be seen from above.
- (4) Turn off the Controller.



**Removal** Remove the screws, and then remove the Arm #2 outside cover.



**Installation** Install the Arm #2 outside cover to the Manipulator.  
Tightening torque:  $0.45 \pm 0.05 \text{ N}\cdot\text{m}$

Cross recessed binding head machine screw: 6-M3×6

**NOTE** The cover may get broken if it is fastened too tight. Be careful not to exceed the above tightening torque.

### 3.6 Joint #3 Cover



- When installing the cover, be careful not to get the cables caught in it or bend them forcibly to push into the cover. Unnecessary strain on cables may result in damage to the cables, disconnection, and/or contact failure. These are extremely hazardous and may result in electric shock and/or improper function of the robot system. When routing the cables, check the cable locations at removing the cover. Be sure to place the cables back to their original locations.

#### Removal

- (1) Remove the Arm #2 outside cover.

For details, refer to *Maintenance 3.5 Arm #2 Outside Cover*.

- (2) Remove the screws, and then remove the Joint #3 cover.

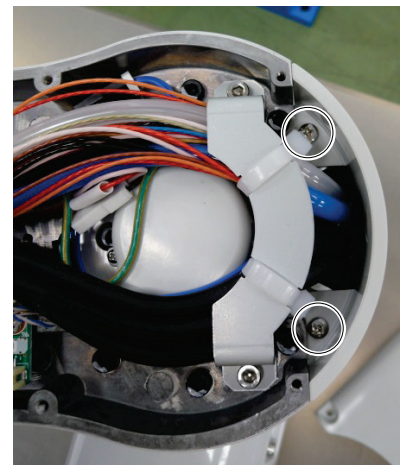

#### Installation

- (1) Install the Joint #3 cover to the Manipulator.

Tightening torque:  $0.45 \pm 0.05$  N·m

Cross recessed binding head machine screw: 2-M3×12



Be careful not to get the cables caught in the cover.

The cover may get broken if it is fastened too tight.

Be careful not to exceed the above tightening torque.

- (2) Install the Arm #2 outside cover.

For details, refer to *Maintenance 3.5 Arm #2 Outside Cover*.

### 3.7 Arm #2 Inside Cover

 CAUTION	<ul style="list-style-type: none"> <li>When installing the cover, be careful not to get the cables caught in it or bend them forcibly to push into the cover. Unnecessary strain on cables may result in damage to the cables, disconnection, and/or contact failure. These are extremely hazardous and may result in electric shock and/or improper function of the robot system. When routing the cables, check the cable locations at removing the cover. Be sure to place the cables back to their original locations.</li> </ul>
--	---

If it is difficult to remove the cover, change the Manipulator posture by following the steps below.

- (1) Turn on the Controller.
- (2) Release the Joint #3 brake.
 

EPSON  
RC+

 Command > brake off, 3
- (3) Turn the Arm #3 about 90 degrees so that the screws of the Arm #2 inside cover can be seen from above.
- (4) Turn off the Controller.



**Removal** Remove the screws, and then remove the Arm #2 inside cover.



**Installation** Install the Arm #2 inside cover to the Manipulator.  
Tightening torque: 0.45 ± 0.05 N·m

Cross recessed binding head machine screw: 5-M3×6

**NOTE**  The cover may get broken if it is fastened too tight. Be careful not to exceed the above tightening torque.

### 3.8 Arm #3 Upper Cover

 <b>CAUTION</b>	<ul style="list-style-type: none"> <li>■ When installing the cover, be careful not to get the cables caught in it or bend them forcibly to push into the cover.                      Unnecessary strain on cables may result in damage to the cables, disconnection, and/or contact failure. These are extremely hazardous and may result in electric shock and/or improper function of the robot system.</li> <li>When routing the cables, check the cable locations at removing the cover.                      Be sure to place the cables back to their original locations.</li> </ul>
---	--

If it is difficult to remove the cover, change the Manipulator posture by following the steps below.

- (1) Turn on the Controller.
- (2) Release the Joint #2 brake.

EPSON RC+	Command > brake off, 2
--------------	---------------------------

- (3) Turn the Arm #2 about 90 degrees so that the screws of the Arm #3 upper cover can be seen from above.
- (4) Turn off the Controller.



**Removal** Remove the screws, and then remove the Arm #3 upper cover.



**Installation** Install the Arm #3 upper cover to the Manipulator.  
 Tightening torque:  $0.45 \pm 0.05 \text{ N}\cdot\text{m}$

Cross recessed binding head machine screw: 2-M3×6

**NOTE**  Be careful not to get the cables caught in the cover.  
 The cover may get broken if it is fastened too tight.  
 Be careful not to exceed the above tightening torque.

### 3.9 Arm #3 Outside Cover

 <p>CAUTION</p>	<ul style="list-style-type: none"><li>■ When installing the cover, be careful not to get the cables caught in it or bend them forcibly to push into the cover. Unnecessary strain on cables may result in damage to the cables, disconnection, and/or contact failure. These are extremely hazardous and may result in electric shock and/or improper function of the robot system. When routing the cables, check the cable locations at removing the cover. Be sure to place the cables back to their original locations.</li></ul>
--	---

Removal

- (1) Remove the Arm #3 upper cover.

For details, refer to *Maintenance 3.8 Arm #3 Upper Cover*.

- (2) Remove the screws, and then remove the Arm #3 outside cover.

**NOTE**  
 The cable is connected to the inside of the Arm #3 outside cover. When removing the cover, be careful not to pull the cable forcibly.

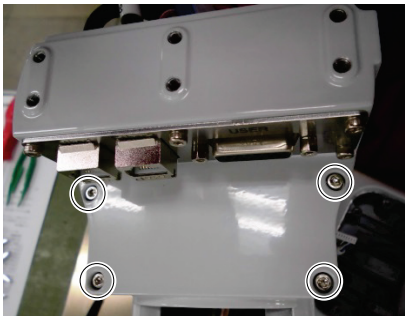

Installation

- (1) Install the Arm #3 outside cover to the Manipulator.

Tightening torque:  $2 \pm 0.1 \text{ N}\cdot\text{m}$

**NOTE**  
 Be careful not to get the cables caught in the cover.

- (2) Install the Arm #3 upper cover.

For details, refer to *Maintenance 3.8 Arm #3 Upper Cover*.

Hexagon socket head cap bolt:  
4-M3×15



### 3.10 Arm #3 Side Cover, Arm #3 Upper Side Cover



- When installing the cover, be careful not to get the cables caught in it or bend them forcibly to push into the cover. Unnecessary strain on cables may result in damage to the cables, disconnection, and/or contact failure. These are extremely hazardous and may result in electric shock and/or improper function of the robot system. When routing the cables, check the cable locations at removing the cover. Be sure to place the cables back to their original locations.

If it is difficult to remove the cover, change the Manipulator posture by following the steps below.

- (1) Turn on the Controller.
- (2) Release the Joint #3 brake.
 

EPSON  
RC+

 Command  
> brake off, 3
- (3) Turn the Arm #3 about 90 degrees so that the screws of the Arm #3 side covers can be seen from every angle.
- (4) Turn off the Controller.



#### Removal

- (1) Remove the following covers.  
 Arm #4 right side cover    Arm #4 left side cover.  
 For details, refer to *Maintenance 3.11 Arm #4 Right Side Cover*, and *3.12 Arm #4 Left Side Cover*.

- (2) Remove the screws, and then remove the Arm #3 side covers (2 covers).



Cross recessed binding head machine screw: 2-M3×6 (×2)

- (3) Remove the screws, and then remove the Arm #3 upper side covers (2 covers).

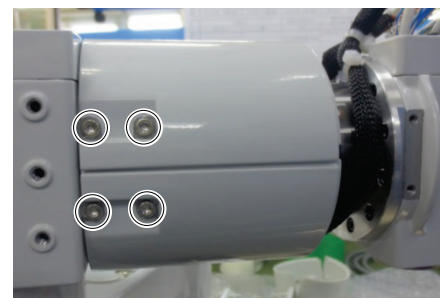

Hexagon socket head cap bolt:  
4-M3×8 (×2)

- Installation (1) Install the Arm #3 upper side covers (2 covers) to the Manipulator.

Tightening torque:  $2 \pm 0.1 \text{ N}\cdot\text{m}$

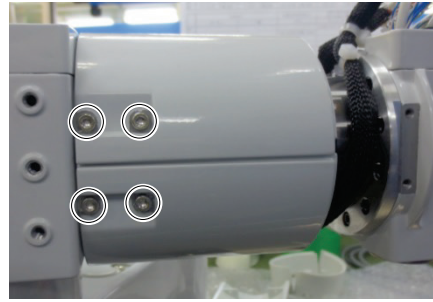

Hexagon socket head cap bolt:  
4-M3×8 (×2)

- (2) Install the Arm #3 side covers (2 covers) to the Manipulator.

Tightening torque:  $0.45 \pm 0.05 \text{ N}\cdot\text{m}$



Cross recessed binding head  
machine screw: 2-M3×6 (×2)

NOTE



The cover may get broken if it is fastened too tight.  
Be careful not to exceed the above tightening torque.

- (3) Install the following covers.

Arm #4 right side cover

Arm #4 left side cover.

For details, refer to

*Maintenance 3.11 Arm #4 Right Side Cover*

*Maintenance 3.12 Arm #4 Left Side Cover.*

### 3.11 Arm #4 Right Side Cover



CAUTION

- When installing the cover, be careful not to get the cables caught in it or bend them forcibly to push into the cover. Unnecessary strain on cables may result in damage to the cables, disconnection, and/or contact failure. These are extremely hazardous and may result in electric shock and/or improper function of the robot system. When routing the cables, check the cable locations at removing the cover. Be sure to place the cables back to their original locations.

If it is difficult to remove the cover, change the Manipulator posture by following the steps below.

- (1) Turn on the Controller.
- (2) Release the Joint #3 brake.

EPSON  
RC+

Command  
> brake off, 3

- (3) Turn the Arm #3 about 90 degrees so that the screws of the Arm #4 right side cover can be seen from above.
- (4) Turn off the Controller.

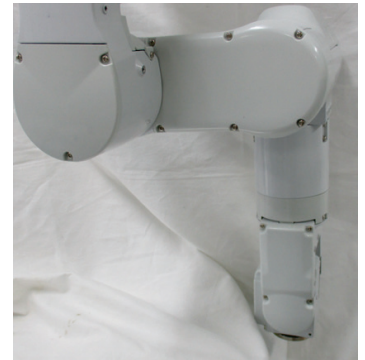

#### Removal

Remove the screws, and then remove the Arm #4 right side cover.



#### Installation

Install the Arm #4 right side cover to the Manipulator.

Tightening torque:  $0.45 \pm 0.05$  N·m



NOTE

The cover may get broken if it is fastened too tight. Be careful not to exceed the above tightening torque.

Cross recessed binding head  
machine screw: 4-M3×6

### 3.12 Arm #4 Left Side Cover

 CAUTION	<ul style="list-style-type: none"> <li>When installing the cover, be careful not to get the cables caught in it or bend them forcibly to push into the cover. Unnecessary strain on cables may result in damage to the cables, disconnection, and/or contact failure. These are extremely hazardous and may result in electric shock and/or improper function of the robot system. When routing the cables, check the cable locations at removing the cover. Be sure to place the cables back to their original locations.</li> </ul>
--	---

If the Arm #4 left side cover is overlapped by another arm, or if it is difficult to remove the cover, change the Manipulator posture by following the steps below.

- (1) Turn on the Controller.
- (2) Release the Joint #3 brake.
 

EPSON  
RC+

 Command  
 > brake off, 3
- (3) Turn the Arm #3 about 90 degrees so that the screws of the Arm #4 left side cover can be seen from above.
- (4) Turn off the Controller.



**Removal**

Remove the screws, and then remove the Arm #4 left side cover.



**Installation**

Install the Arm #4 left side cover to the Manipulator.

Tightening torque:  $0.45 \pm 0.05 \text{ N}\cdot\text{m}$

**NOTE**  Be careful not to get the cables caught in the cover. The cover may get broken if it is fastened too tight. Be careful not to exceed the above tightening torque.

Cross recessed binding head machine screw: 4-M3×6

### 3.13 Arm #5 Side Cover



- When installing the cover, be careful not to get the cables caught in it or bend them forcibly to push into the cover. Unnecessary strain on cables may result in damage to the cables, disconnection, and/or contact failure. These are extremely hazardous and may result in electric shock and/or improper function of the robot system. When routing the cables, check the cable locations at removing the cover. Be sure to place the cables back to their original locations.

If the Arm #5 side cover is facing inside the Arm #4, or if it is difficult to remove the cover, change the Manipulator posture by following the steps below.

- (1) Turn on the Controller.
- (2) Release the Joint #5 brake.

**EPSON RC+** Command  
> brake off, 5

- (3) Turn the Arm #3 so that the screws of the Arm #5 side cover can be seen from above.
- (4) Turn off the Controller.

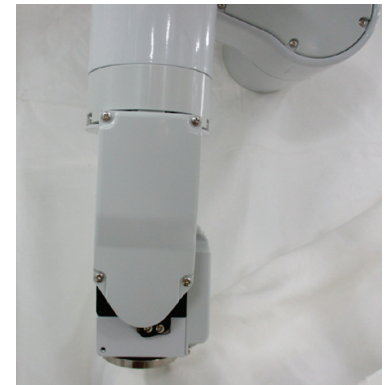

**Removal** Remove the screws, and then remove the Arm #5 side cover.

**Installation** Install the Arm #5 side cover to the Manipulator.

Tightening torque:  $0.45 \pm 0.05$  N·m

**NOTE**  The cover may get broken if it is fastened too tight. Be careful not to exceed the above tightening torque.



Cross recessed binding head machine screw: 4-M3×6

### 3.14 Arm #5 Upper Cover

 CAUTION	<ul style="list-style-type: none"> <li>When installing the cover, be careful not to get the cables caught in it or bend them forcibly to push into the cover. Unnecessary strain on cables may result in damage to the cables, disconnection, and/or contact failure. These are extremely hazardous and may result in electric shock and/or improper function of the robot system. When routing the cables, check the cable locations at removing the cover. Be sure to place the cables back to their original locations.</li> </ul>
--	---

If it is difficult to remove the cover, change the Manipulator posture by following the steps below.

- (1) Turn on the Controller.
- (2) Release the Joint #5 brake.
 

EPSON RC+	Command
--------------	---------

> brake off, 5
- (3) Turn the Arm #5 about 90 degrees so that the screws of the Arm #5 upper cover can be seen from above.
- (4) Turn off the Controller.



**Removal** Remove the screws, and then remove the Arm #5 upper cover.

**Installation** Install the Arm #5 upper cover to the Manipulator.  
Tightening torque:  $0.45 \pm 0.05 \text{ N}\cdot\text{m}$

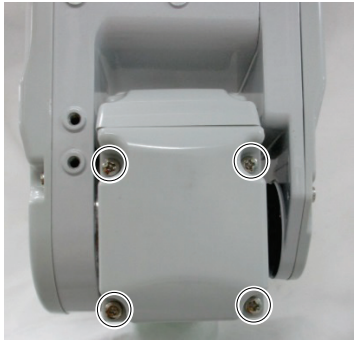

**NOTE** The cover may get broken if it is fastened too tight. Be careful not to exceed the above tightening torque.

Cross recessed binding head machine screw: 4-M3×6

### 3.15 Base Cover



CAUTION

- When installing the cover, be careful not to get the cables caught in it or bend them forcibly to push into the cover. Unnecessary strain on cables may result in damage to the cables, disconnection, and/or contact failure. These are extremely hazardous and may result in electric shock and/or improper function of the robot system. When routing the cables, check the cable locations at removing the cover. Be sure to place the cables back to their original locations.

**NOTE**  When the tool cannot reach the screws fixing the base cover while the Manipulator is installed on the table, remove the cover by removing the base from the base plate.

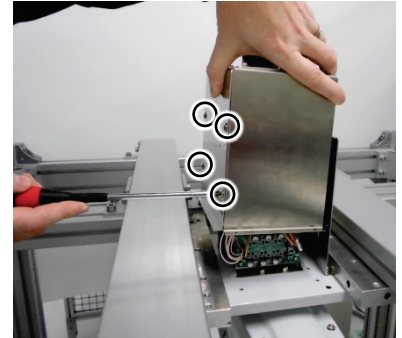

**Removal** Remove the screws, and then remove the base cover.

**Installation** Install the base cover to the Manipulator.

Tightening torque:  $0.9 \pm 0.1 \text{ N}\cdot\text{m}$

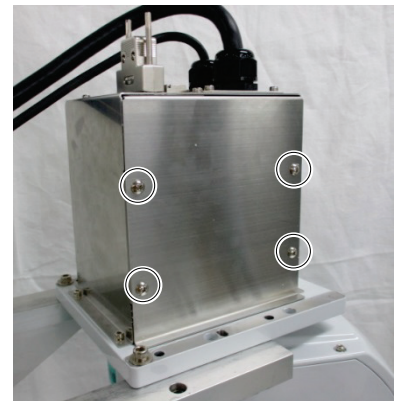

Cross recessed truss head small screws: 5-M4×5

### 3.16 Connector Plate

 CAUTION	<ul style="list-style-type: none"> <li>■ Do not remove the connector plate forcibly. It may result in damage to the cables, disconnection, and/or contact failure. These are extremely hazardous and may result in electric shock and/or improper function of the robot system.</li> <li>■ When installing the connector plate, be careful not to get the cables caught in it or bend them forcibly to push into the cover.</li> </ul> <p>Unnecessary strain on cables may result in damage to the cables, disconnection, and/or contact failure. These are extremely hazardous and may result in electric shock and/or improper function of the robot system. When routing the cables, check the cable locations at removing the connector plate. Be sure to place the cables back to their original locations.</p>
--	--

**Removal**            Remove the bolts, and then remove the connector plate.

**Installation**        Install the connector plate to the Manipulator.

Tightening torque:  $4.0 \pm 0.2 \text{ N}\cdot\text{m}$

**NOTE**



Be careful not to get the cables caught in the plate.



Hexagon socket head cap bolts:  
4-M4×8



## 4. Cable Unit and FPC Unit

### 4.1 Replacing the Cable Unit



WARNING

- Before performing any replacement procedure, turn OFF the Controller and related equipment, and then disconnect the power plug from the power source. Performing any replacement procedure with the power ON is extremely hazardous and may result in electric shock and/or malfunction of the robot system.
- Do not connect or disconnect the motor connectors while the power to the robot system is turned ON. Connecting or disconnecting the motor connectors with the power ON is extremely hazardous and may result in serious bodily injury as the Manipulator may move abnormally, and also may result in electric shock and/or malfunction of the robot system.
- Be sure to connect the AC power cable to a power receptacle. DO NOT connect it directly to a factory power source. To shut off power to the robot system, disconnect the power plug from the power source. Performing any work while connecting the AC power cable to a factory power source is extremely hazardous and may result in electric shock and/or malfunction of the robot system.
- Be careful not to get any foreign substances in the Manipulator, connectors, and pins during maintenance. Turning ON the power to the robot system when any foreign substances exist in them is extremely hazardous and may result in electric shock and/or malfunction of the robot system.
- Be sure to connect the cables properly. Do not allow unnecessary strain on the cables. (Do not put heavy objects on the cables. Do not bend or pull the cables forcibly.) Unnecessary strain on the cables may result in damage to the cables, disconnection, and/or contact failure. These are extremely hazardous and may result in electric shock and/or improper function of the robot system.
- When installing the cover, be careful not to allow the cables to interfere with the cover mounting and do not bend these cables forcibly to push them into the cover. Unnecessary strain on cables may result in damage to the cables, disconnection, and/or contact failure. Damaged cables, disconnection, or contact failure is extremely hazardous and may result in electric shock and/or improper function of the robot system.  
When routing the cables, observe the cable locations after removing the cover. Be sure to place the cables back to their original locations.



CAUTION

- When disconnecting the connectors during the replacement of the cable unit, be sure to reconnect the connectors to their proper positions. Improper connection of the connectors may result in improper function of the robot system.  
For details on the connections, refer to the *Maintenance 4.5 Connector Pin Assignments*.



CAUTION

- When installing the cover, be careful not to get the cables caught in it or bend them forcibly to push into the cover.

Unnecessary strain on cables may result in damage to the cables, disconnection, and/or contact failure. These are extremely hazardous and may result in electric shock and/or improper function of the robot system.

When routing the cables, check the cable locations at removing the cover. Be sure to place the cables back to their original locations.

	Name		Quantity	Note
Maintenance Parts	Cable unit (HP CABLE A UNIT)		1	2186101
	Wire tie	AB150	-	1675754, 1 bag (100 ties: white)
		AB200	-	1684328, 1 bag (100 ties: white)
Tools	Hexagonal wrench	width across flats: 2.5 mm	1	For M3 hexagon socket head cap bolts
		width across flats: 3 mm	1	For M4 hexagon socket head cap bolts
		width across flats: 3 mm	1	For M4 hexagon socket head cap bolts, short head
		width across flats: 4 mm	1	For M5 hexagon socket head cap bolts
		width across flats: 5 mm	1	For M6 hexagon socket head cap bolts
	Box wrench	width across flats: 5 mm	1	For D-Sub connector
	Long nose pliers		1	For removing air tubes
	Nippers		1	For cutting a wire tie
	Cross-point screwdriver (#2)		1	For cross recessed head screws
	Torque wrench		1	For tightening torque control
	Cable tie gun		1	Refer: HellermannTyton MK8
	Cable tie gun tester		1	Refer: HellermannTyton DGT500-MK8

### Removal: Cable Unit

#### Removal

- (1) Remove the following covers.

Arm #4 left side cover

Arm #3 side cover

Arm #3 upper cover

Arm #2 inside cover

Joint #2 cover

Arm #1 inside cover

Arm #3 upper side cover

Arm #3 outside cover

Joint #2 outside cover

For details, refer to *Maintenance 3. Covers*.

- (2) Turn ON the Controller.

- (3) Release the Joint #2 and #3 brakes.

EPSON RC+	Command
	>brake off, 2
	>brake off, 3

- (4) Move the Manipulator to be as shown on the right.

- (5) Turn OFF the Controller.

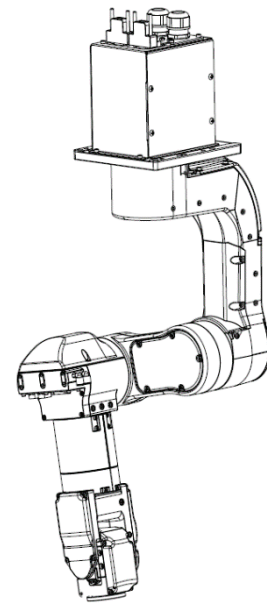

- (6) Remove the base cover.

Cross recessed truss screw: 4-M4×5

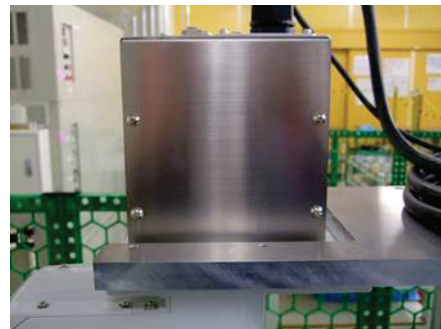

- (7) Remove the M/C cable.

For details, refer to *Maintenance 4.4 Replacing the M/C Cable*.

- (8) Remove the brake release connector.



- (9) Remove the base.

Hexagon socket head cap bolt: 9-M4×8

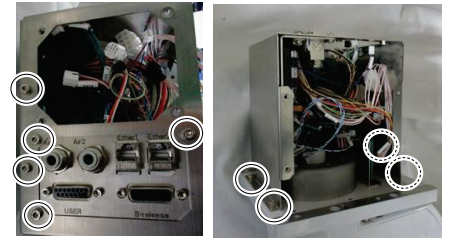

- (10) Remove the following connectors on the board inside the base and the two tubes.

Connectors:

USER1-B, USER2-B, BAT\_CN3,  
 BAT\_CN6, EB01\_CN1, EB0x\_CN2,  
 EB01\_CN3, FIL\_CN3, FIL\_CN4, PW1,  
 BRK\_CN1, BRK\_CN2, BR\_CN3

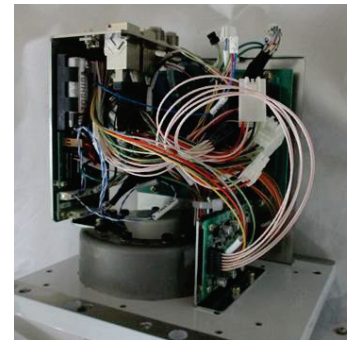

**NOTE**  Be careful that the jumper pins on the board do not come off.

- (11) Remove the filter board unit.

Hexagon socket head cap bolt: 2-M4×8

**NOTE**  Do not remove the board.

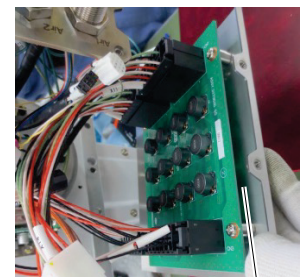

Filter board unit

- (12) Remove the D-sub connector indicated as “USER”.

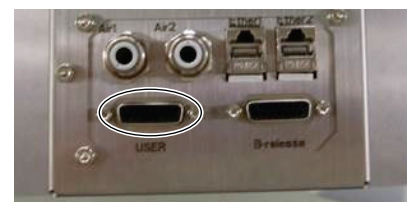

(13) Remove the ground wires.

Hexagon socket head cap bolt: 6-M4×5

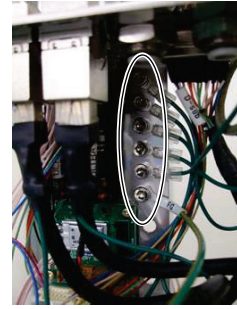

(14) Remove the user wire plate.

Hexagon socket head cap bolt: 2-M4×8

NOTE



Do not remove the board and the battery.

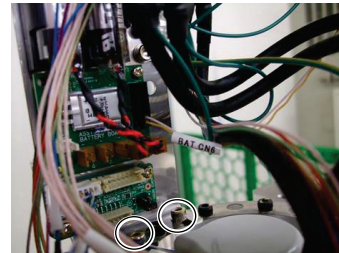

(15) Cut off the wire tie.

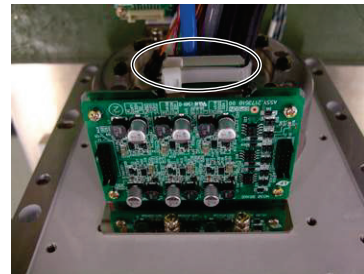

(16) Remove the base plate.

Hexagon socket head cap bolt: 8-M4×20

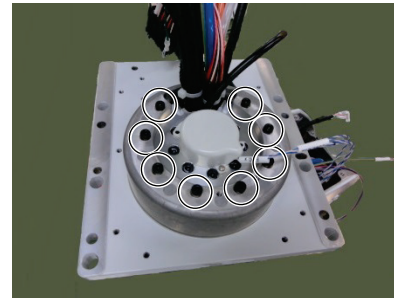

(17) Remove the following covers.

Arm #1 outside cover

Joint #1 cover

For details, refer to *Maintenance 3. Covers*.

(18) Loosen the FPC Power Connector mounting screws and remove the following connectors. .

Connector:

PW5, J6P-01, BR5, FL\_CN2, EB05\_CN1

NOTE



Be careful that the jumper pins on the board do not come off.

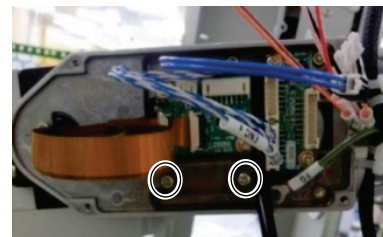

(19) Remove the ground wire (FG).

Cross recessed screw: M4×6

(20) Cut off the four wire ties fixed to the Arm #4.

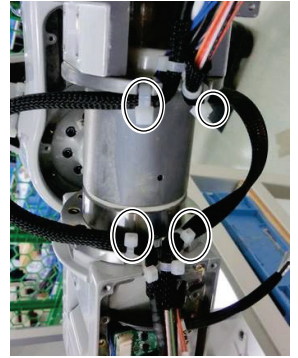

(21) Remove the Arm #3 outside cover.

Hexagon socket head cap bolt: 4-M3×15

For details, refer to *Maintenance 3. Covers*.

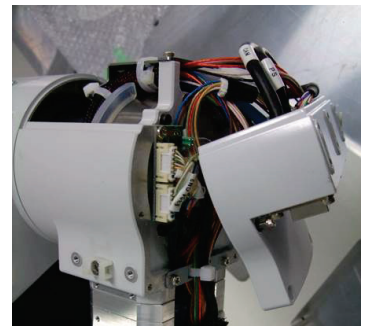
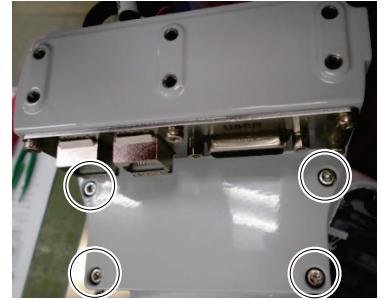

(22) Remove the following connectors.

Connector: USER1, USER2, X71, X72

(23) Remove the two air tubes.

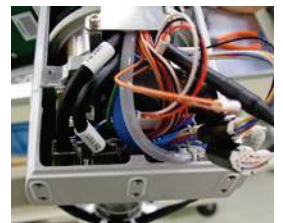

(24) Cut off wire tie of the cable fixing plate.

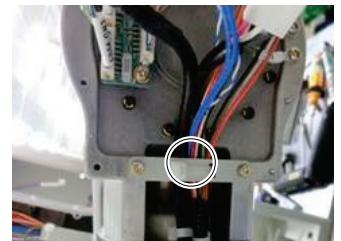

- (25) Remove the cable fixing plate and pull out the cables.

Hexagon socket head cap bolt: 2-M3×6

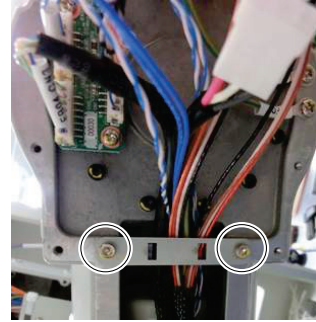

- (26) Remove the following connectors.

Connector:

PW4, BR4, EB04\_CN3, EB04\_CN1

**NOTE**  When the connector EB04\_CN3 is removed, a bundle of cables will be removed.

**NOTE**  Be careful that the jumper pins on the board do not come off.

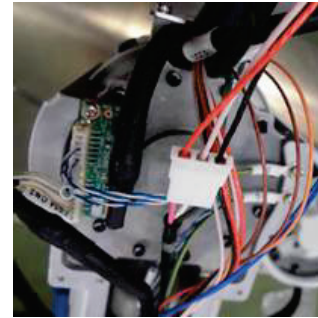

- (27) Remove the two ground wires (FG).

Cross recessed screw: 2-M4×6

- (28) Cut off the wire ties (3 ties) fixing the cables to the plate.

- (29) Remove the cable fixing plate.

Hexagon socket head cap bolt: 2-M3×6

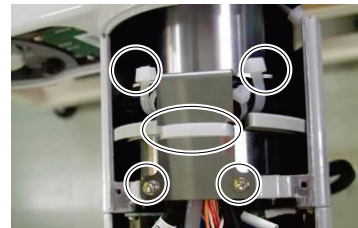

- (30) Remove the Joint #3 cover.

Cross recessed screw: 2-M3×12

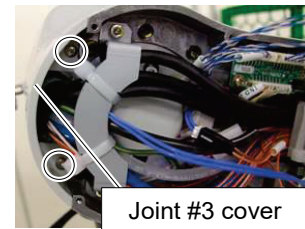

- (31) Cut off the wire tie.

For plate: 2 ties

For flange: 2 ties

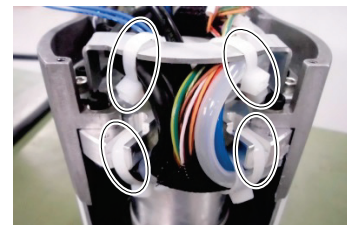

- (32) Remove the cable fixing plate.

Hexagon socket head cap bolt: 2- M4×6

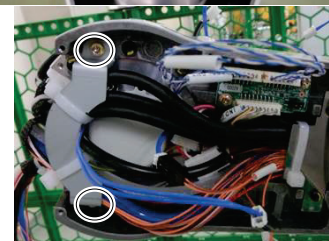



(33) Remove the connectors.

Connector:

PW2, PW3, BR2, BR3, EB02\_CN1,  
EB0x\_CN3 (comes from the Joint #2 side.)

**NOTE**  Be careful that the jumper pins on the board do not come off.

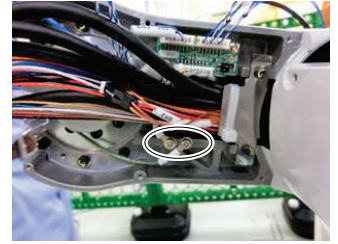

(34) Remove the ground wires (FG, 2 wires).

Cross recessed screw: 2-M4×6

(35) Remove the control board 2.

Cross recessed screw: 4-M3×6

**NOTE**  Keep the control board 2 not to lose it.

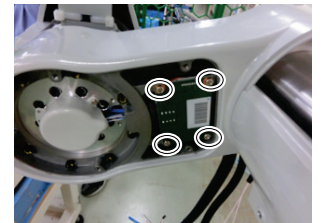

(36) Remove the connector.

Connector: GS02



(37) Remove the screws fixing the cable fixing plate.

Hexagon socket head cap bolt: 2-M3×6

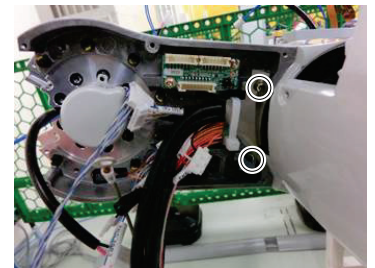

(38) Remove the Arm #2.

Hexagon socket head cap bolt: 8-M4×20

**NOTE**  When removing the Arm #2, check if the cables are caught.



(39) Cut off the wire ties (3 ties) fixing the plate and the cables.

**NOTE**  One of the fixing plates comes off. Be careful not to lose it.

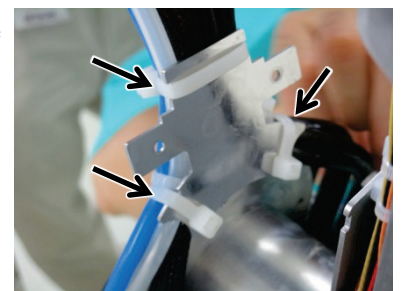

(40) Remove the cable fixing plate.

Hexagon socket head cap bolt: 2-M3×6  
(indicated with circles)

Remove the ground wire (FG).

Cross recessed screw: M4×6  
(indicated with triangles)

Cut off the wire ties (6 ties: indicated with arrows)  
fixing the plate and the cable unit.

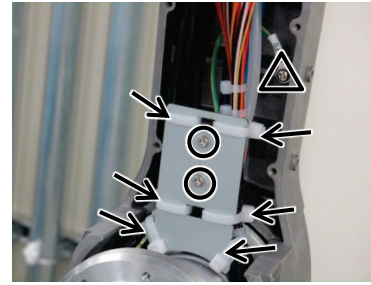

NOTE The fixing plates come off.

 Be careful not to lose them.

(41) Remove the following connector.

Connector: GS01

Cross recessed screw: 4-M3×6

(42) Remove the control board 1.

NOTE  Keep the board not to lose it.



(43) Pull the cables to the upper side of the Arm #1.



(44) Remove the ground wire.

Hexagon socket head cap bolt: M4×6

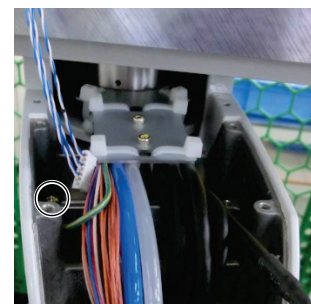

(45) Cut off the wire ties (indicated with arrows) fixing the cables.

For plate: 6 ties  
For flange: 2 ties

(46) Remove the cable fixing plate.

Hexagon socket head cap bolt: 2-M3×6  
(indicated with circles)

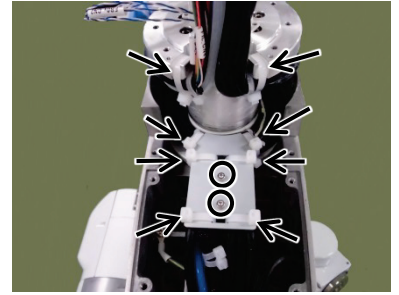

NOTE

 The fixing plate comes off. Be careful not to lose it.

(47) Remove the cables.

**Installation: Cable Unit**

**Installation**

(1) Check if you have the cable units A, B, and C shown in the photo.

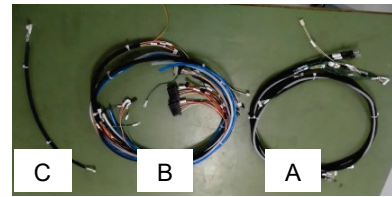

**NOTE** Be careful of the following:  
 When the wire ties are accidentally cut off or moved, the cable units cannot be installed properly.

- Do not cut off the wire ties binding the cables.
- Do not move the wire ties on the cables.

(2) Apply the grease.

**Grease**  
 Krytox: 4 g in total (approximate)



Cable unit A

**NOTE** Excessive grease increases the possibility of grease leakage from the Manipulator.

**Grease amount and application point**  
 Cable unit A: 1.5 g  
 Between the first and second wire ties from the base.



Cable unit B

Cable unit B: 1.5 g  
 Between the first and second wire ties from the base.

Apply half of the grease to the inner and outer sides of the braided tube for each.

**NOTE** Apply the grease to each cable evenly.

Base plate (inner wall of the base): 0.5 g  
 Joint #1 of Arm #1 (inner side): 0.5 g  
 If you wiped off the grease applied before replacing the cables, apply new grease only to the part where the cables touch.

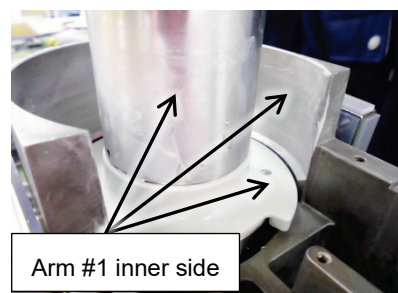
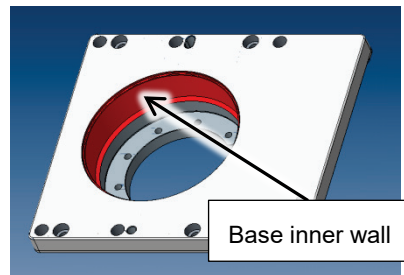

- (3) Fix the cable units A and B to the cable fixing plate.

Wire tie (AB200): 6 ties

Tightening strength:  $85 \pm 5$  N

Be careful of installation positions of the cable units A and B.

Details are given below.

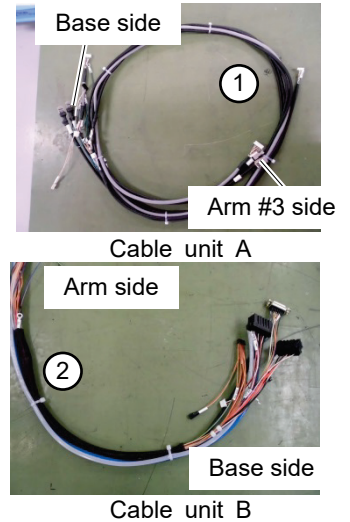

First, fix the cable unit while aligning to the fixing plate. (2 places)

Wire tie (AB200): 2 ties

- Align positions of the second wire ties from the base (1, 2) on the cable units A and B.

- Face the cable units to the following directions:

Gray colored cable of the cable unit A  
: Face to the fixing plate

Air tubes of the cable unit B  
: Face to the opposite side of fixing plate

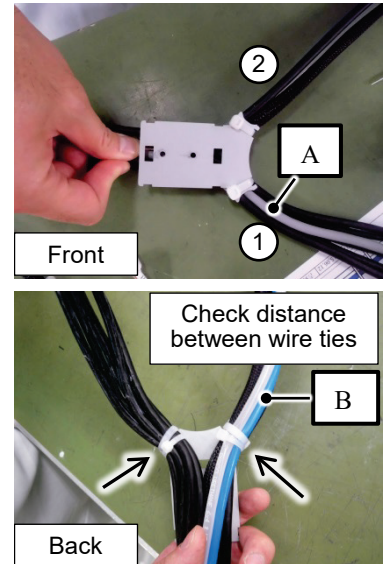

**NOTE** Be careful of fixing positions of the wire ties (indicated with arrows).

**NOTE** The wire ties fixing the cable units to the plate (1, 2) should be as close to the ones binding the cables as possible.

The life of the cables may be shorter when the wire ties are separated.

- (4) Install the cable fixing plate to the Arm #1.

Hexagon socket head cap bolt: 2-M3×6

Tightening torque:  $2.4 \pm 0.1$  N·m

**NOTE** Be careful not to tighten the screws with the cables get caught in the plate.

Then, fix the cable units to the fixing plate.

Wire tie (AB200): 4 ties

Tightening strength:  $85 \pm 5$  N

**NOTE** Be careful of positions of the wire ties (indicated with arrows).

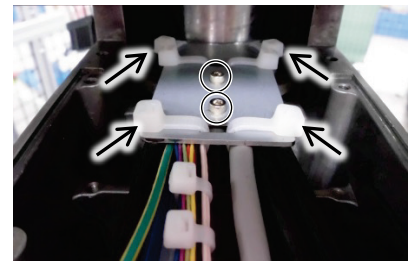

- (5) Bind the discrete cables of the cable unit B.  
 Wire tie (AB150) : 2 ties  
 Tightening strength:  $85 \pm 5$  N

Wire tie 1:  
 10 mm from the cable fixing plate.  
 Wire tie 2:  
 Leave 10 mm from the wire tie 1.

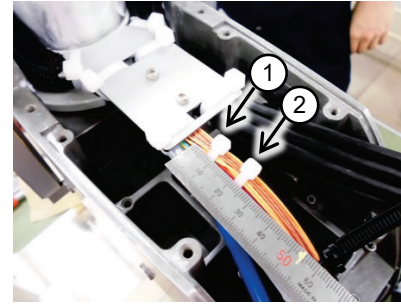

- (6) Pass the cable unit A through the Joint #1 and fix it to the flange with the wire tie.  
 Wire tie (AB200): 1 tie  
 Tightening strength:  $85 \pm 5$  N

First, insert the cable unit A to the inside of the Manipulator while bending it to make a U shape.

Then, twist the cable unit A 180 degrees to the direction of the arrow.

Twist can be checked by the position of the gray colored cable of the cable unit.

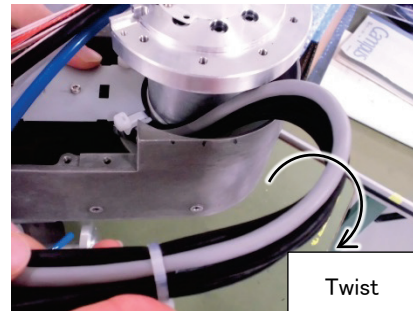
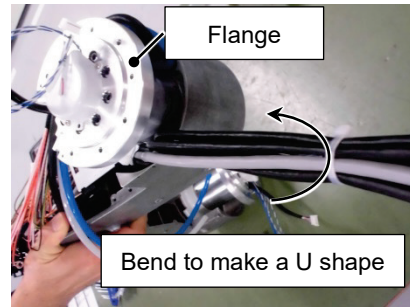

Fix the cable unit A with the wire tie (AB200) so that the gray colored cable faces the flange. At this point, tighten the wire tie to be adjacent to the one fixing the cable unit A. (See the photo on the right)

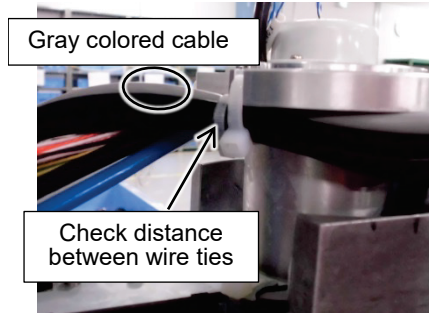

**NOTE**  The wire ties fixing the cable units to the flange should be as close to the ones binding the cables as possible. The life of the cables may be shorter when the wire ties are separated.

Refer to the figure for positions of the wire tie heads.

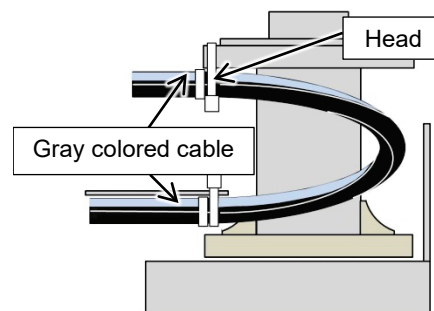

- (7) Pass the cable unit B through the Joint #1 and fix it to the flange with the wire tie.

Wire tie (AB200) : 1 tie

Tightening strength:  $85 \pm 5$  N

Insert the cable unit B to the inside of the Manipulator while bending it to make a U shape in the same manner as the cable unit A.

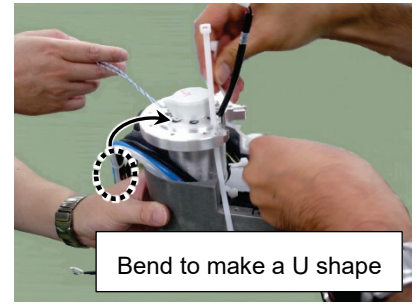

Twist the cable unit B 180 degrees to the direction of the arrow.

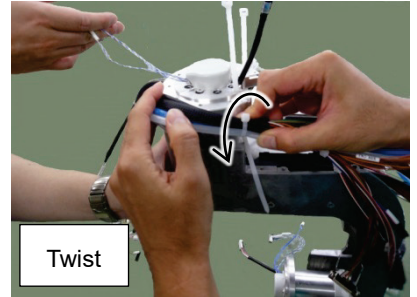



At this point, two air tubes of the cable unit B are at the opposite side of the flange.

Fix the cable unit B with the wire tie (AB200) so that the air tubes are at the opposite side of the flange.

At this point, tighten the wire tie to be adjacent to the one fixing the cable unit.

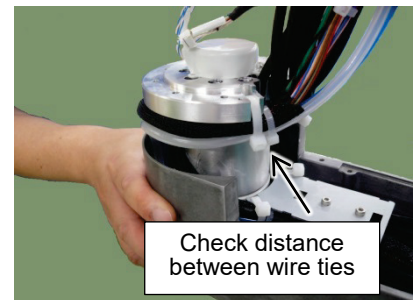
(See the figure)



**NOTE**  The wire ties fixing the cable units to the flange should be as close to the ones binding them as possible.

The life of the cables may be shorter when the wire ties are separated.

Refer to the figure for positions of the wire tie heads.

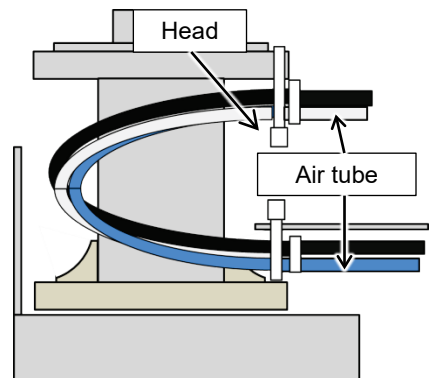

- (8) Pass the cable unit through the Arm #1.

**NOTE**  Inserting the cable unit forcibly while the connectors get caught may result in breakage of the cables and connectors. Be careful when inserting the unit.

Do not pass the following connector through the hole.

Connector: GS01

Disconnect the following connector from hole.

Connector: LED (red circle on the right photo)

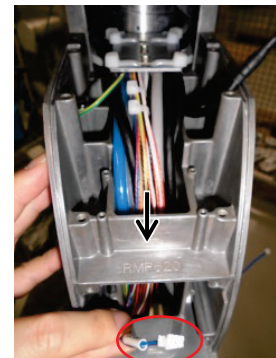

(9) Connect the ground wire.

Cross recessed screw: M4×6

Tightening torque:  $0.6 \pm 0.05$  N·m

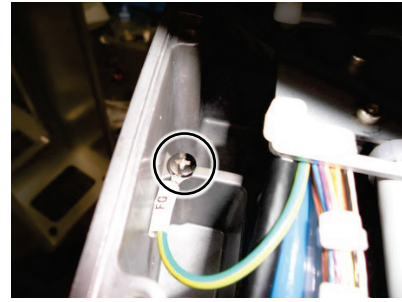

(10) Install the control board 1 and connect the connector.

Connector: GS01

Cross recessed screw: 4-M3×6

Tightening torque:  $0.45 \pm 0.05$  N·m

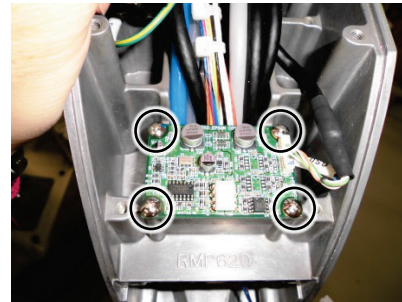

(11) Apply the grease.

Grease

Krytox: 4 g in total (approximate)

**NOTE**  Excessive grease increases the possibility of grease leakage from the Manipulator.



Grease amount and application point

Cable unit A: 1.5 g

Between the third and fourth wire ties from the base.

Cable unit B: 1.5 g

Between the third and fourth wire ties from the base.

Apply half of the grease to the inner and outer sides of the braided tube for each.

Apply the grease to each cable evenly.

Arm #1 Joint #2 (Arm #1 inner side): 0.5 g

Arm #2 Joint #2 (Arm #2 inner side): 0.5 g

If you wiped off the grease applied before replacing the cables, apply new grease only to the part where the cables touch.

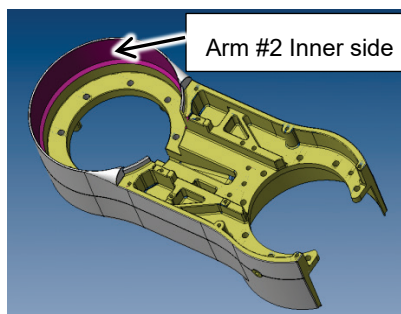
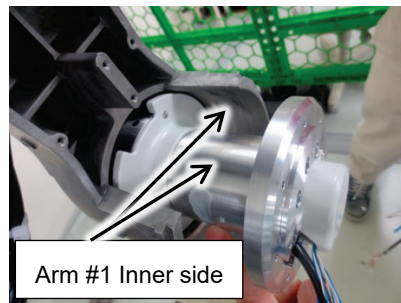



(12) Fix the cable units A and B to the cable fixing plate.

Wire tie (AB200): 2 ties

Tightening strength:  $85 \pm 5\text{N}$

- Face the cable units to the following directions:

Gray colored cable of the cable unit A  
: Face to the fixing plate

Air tubes of the cable unit B  
: Face to the opposite side of fixing plate

- Fix the cable units as close to the wire ties binding the cables as possible.

 **NOTE** The wire ties fixing the cable units to the plate should be as close to the ones binding the cables as possible.

The life of the cables may be shorter when the wire ties are separated.

Refer to the figure for positions of the wire tie heads.

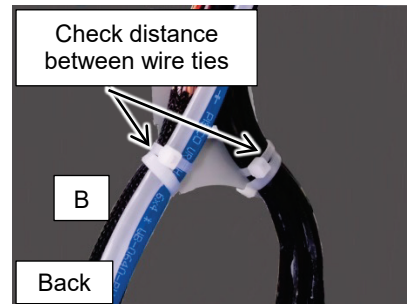
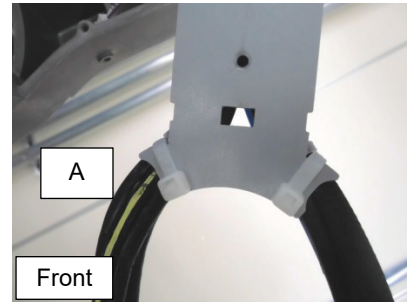

(13) Install the cable fixing plate to the Arm #1.

Hexagon socket head cap bolt: 2-M3×6

Tightening torque:  $2.4 \pm 0.1\text{ N}\cdot\text{m}$

 **NOTE** Be careful not to tighten the screws with the cables get caught in the plate.



(14) Fix the cable units A and B to the cable fixing plate.

Wire tie (AB200) :4 ties

Tightening strength:  $85 \pm 5\text{N}$

Use four wire ties (AB200) to fix the cable units and the plate.

Refer to the figure for positions of the wire tie heads.

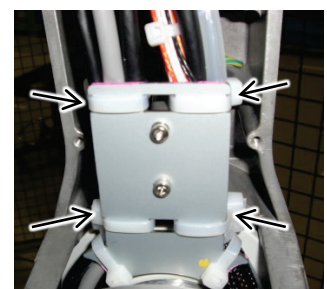

(15) Install the ground wire.

Cross recessed head screw: M4×6

Tightening torque:  $0.6 \pm 0.05\text{ N}\cdot\text{m}$

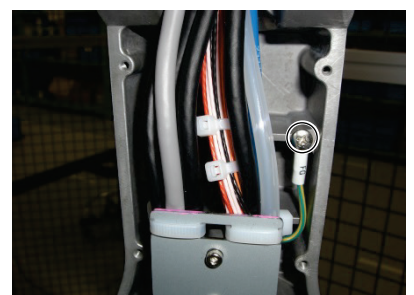

(16) Bind the discrete wires of the cable unit B.

Wire tie (AB150): 2 ties

Tightening strength:  $85 \pm 5$  N

Wire tie 1:

10 mm from the cable fixing plate.

Wire tie 2:

Leave 10 mm from the wire tie 1.

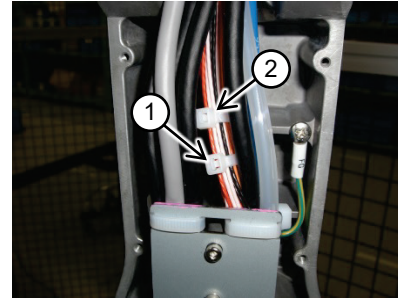

(17) Pass the cable unit A through the Joint #2.

Insert the cable unit A to the inside of the Manipulator while bending it to make a U shape.

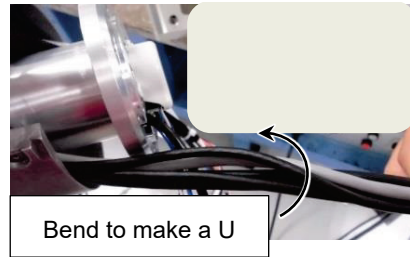

Twist the cable unit A 180 degrees to the direction of the arrow.

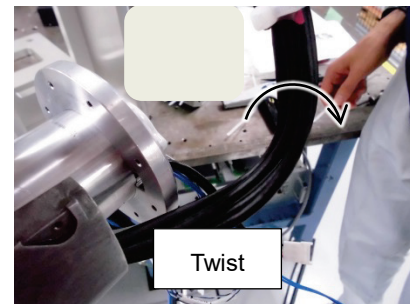

Check that the gray colored cable of the cable unit is at the flange side.

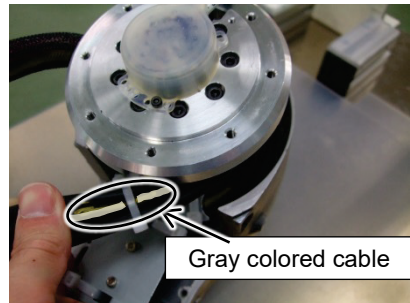

(18) Fix the cable unit A to the cable fixing plate with the wire ties.

Wire tie (AB200): 1 tie

Tightening strength:  $85 \pm 5$  N

Use the plate shown in the photo.

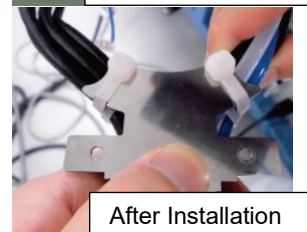
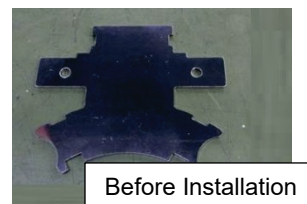

Fix the cable unit A with the wire tie so that the gray colored cable on the unit is at the opposite side of the plate.

In addition, tighten the wire tie to be adjacent to the one fixing the cable unit A.

(See the figure on the right)

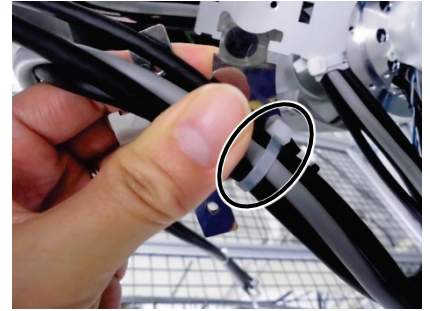

**NOTE**  The wire ties fixing the cable unit to the plate should be as close to the ones binding the cables as possible.

The life of the cables may be shorter when the wire ties are separated.

Be careful of positions of the wire tie heads.

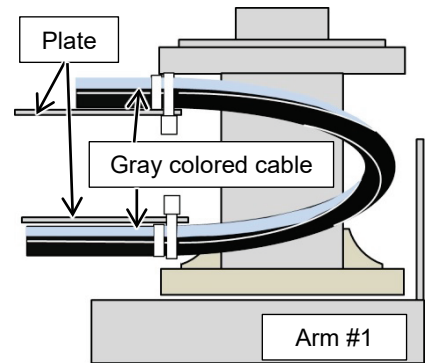

(19) Pass the cable unit B to the Joint #2.

Insert the cable unit B to the inside of the Manipulator while bending it to make a U shape in the same manner as the cable unit A.

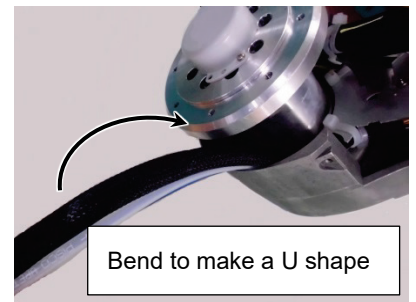

Twist the cable unit B 180 degrees to the direction of the arrow.

At this point, two air tubes of the cable unit B are at the opposite side of the flange.

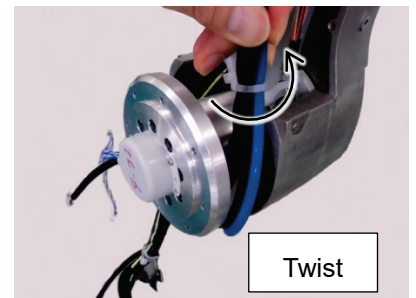

(20) Fix the cable unit B to the cable fixing plate with the wire ties.

Wire tie (AB200): 1 tie

Tightening strength:  $85 \pm 5\text{N}$

Fix the cable unit B with the wire tie (AB200) so that the air tubes of the unit are at the side of the plate.

In addition, tighten the wire tie to be adjacent to the one fixing the cable unit B.  
(See the figure on the right)

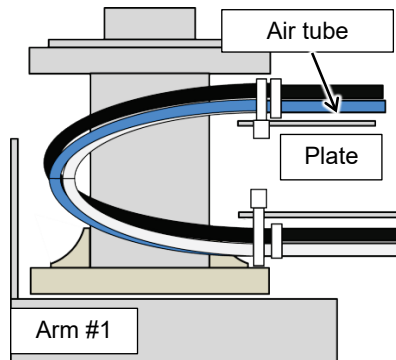
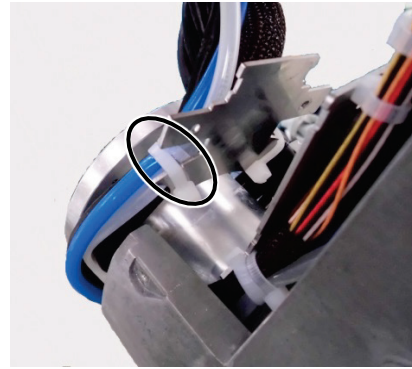

**NOTE**  The wire ties fixing the cable unit to the plate should be as close to the ones binding the cables as possible.  
The life of the cables may be shorter when the wire ties are separated.

Be careful of positions of the wire tie heads.

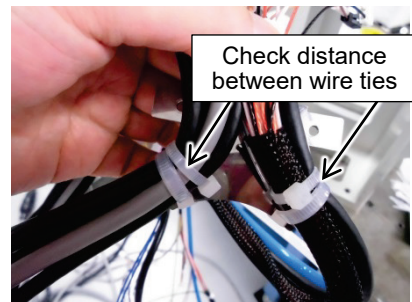

(21) Fix the cable units A and B to the cable fixing plate with the wire tie.

Wire tie (AB200) :1 tie

Tightening strength:  $85 \pm 5\text{N}$

Be careful of position of the wire tie head.

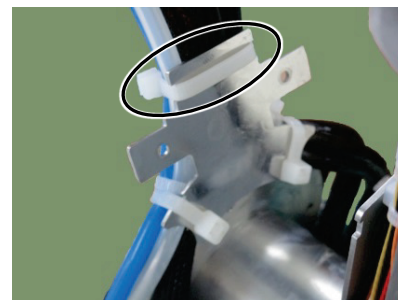

- (22) Fix the Arm #2 to the Joint #2 while aligning the cable unit to the direction of the cables coming from the Joint #2.

Hexagon socket head cap bolt: 8-M4×20

Tightening torque:  $5.5 \pm 0.25$  N·m

**NOTE**



Be careful of the direction of the Arm #2.

The photos on the right are examples for the cable unit removal step (3). If you removed the Arm #2 with a different arm orientation, the direction of the motor cables is different.

Be careful not to get the cables coming from the Joint #2 caught.

Have at least two people to perform this step.

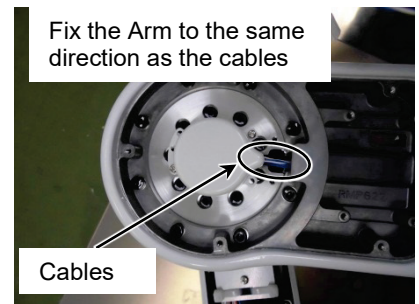
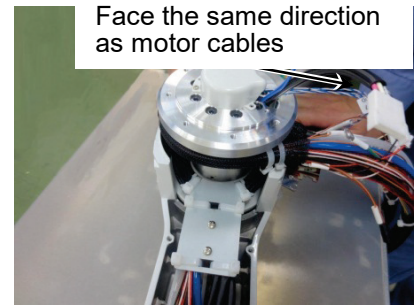

- (23) Pass the connector GS02 to the hole as shown in the photo.



- (24) Connect the connector GS02 to the control board 2, and then install the control board 2 to the Arm #2.

Cross recessed head screw: 2-M3×6

Tightening torque:  $0.45 \pm 0.05$  N·m

**NOTE**



Be careful not to get the cables caught.

It may result in cable breakage.

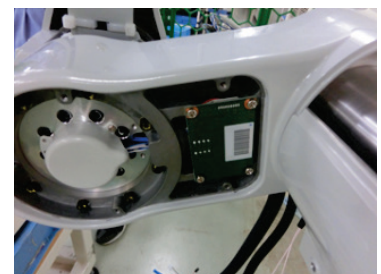

(25) Install the cable fixing plate.

Hexagon socket head cap bolt: 2-M3×6

Tightening torque:  $2.0 \pm 0.1$  N·m

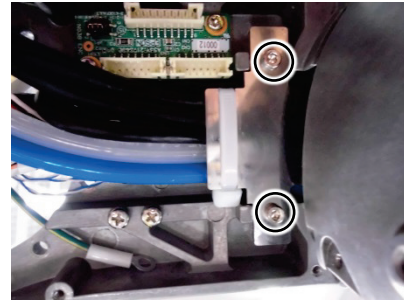

(26) Connect the following connectors.

Connector:

PW2, PW3, BR2, BR3, EB02\_CN1,

EB0x\_CN3 (comes from the Joint #2 side)

NOTE  Be careful that the jumper pins on the board do not come off.

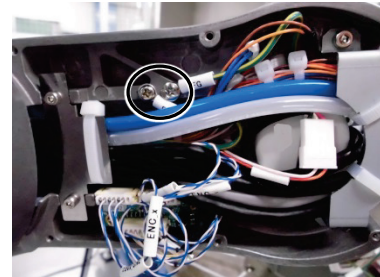

(27) Fix the ground wire.

Cross recessed head screw: 2-M4×6

Tightening torque:  $0.6 \pm 0.05$  N·m

(28) Apply the grease.

Grease

Krytox: 4 g in total (approximate)

NOTE  Excessive grease increases the possibility of grease leakage from the Manipulator.

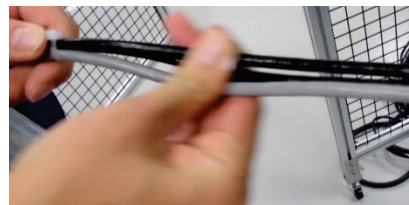

Grease amount and application point

Cable unit A: 1.5 g

Between the fifth and sixth wire ties from the base.



Cable unit B: 1.5 g

Between the fifth and sixth wire ties from the base.

Apply the grease to each cable evenly.

Joint #3 of Arm #2 and #3: 0.5 g

If you wiped off the grease applied before replacing the cables, apply new grease only to the part where the cables touch.

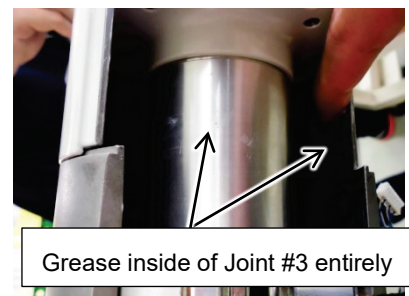

Grease inside of Joint #3 entirely

(29) Pass the cable unit through the Joint #3.

Be careful of the following:

- The cable unit should be passed through the Joint #3 in U-shape like Joint #1 and #2.
- Ensure that the gray colored cable on the cable units can be seen.

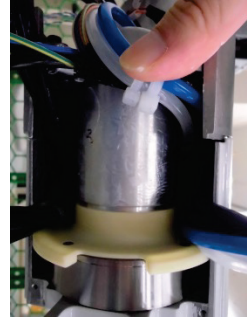

(30) Fix the cable units A and B to the cable fixing plate.

Wire tie (AB200): 2 ties  
Tightening strength:  $85 \pm 5$  N

Cable unit A:

Fix the cable unit with the wire tie (AB200) so that the gray colored cable on the cable faces the opposite side of the flange.

Cable unit B:

Fix the cable unit with the wire tie (AB200) so that the air tubes are at the opposite side of the flange.

Fix the cable units so that the wire ties are adjacent to the ones binding the cable units A and B.

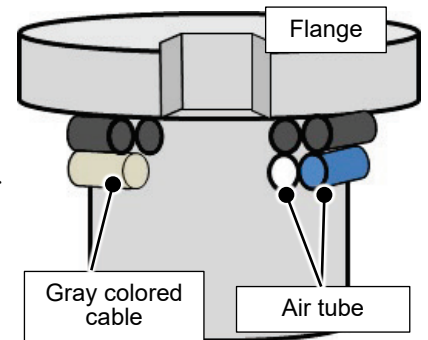
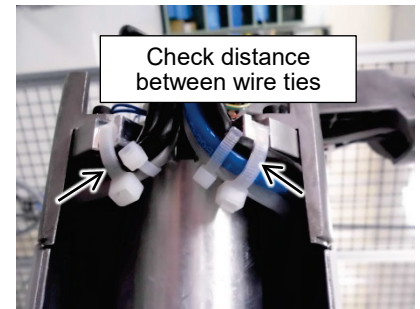

**NOTE** The wire ties fixing the cable units to the flange should be as close to the ones binding the cables as possible.

The life of the cables may be shorter when the wire ties are separated.

Be careful of positions of the wire tie heads.

(31) Install the cable fixing plate to the Arm #2.

Fix the cable unit to the cable fixing plate with the wire ties.

Hexagon socket head cap bolt: 2-M4×6  
Tightening torque:  $2.0 \pm 0.1$  N·m

Wire tie (AB200): 2 ties  
Tightening strength:  $85 \pm 5$  N

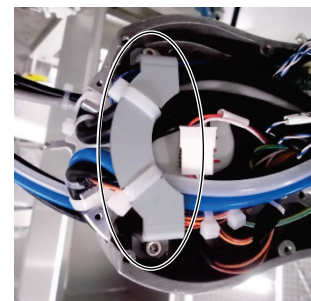

(32) Bind the discrete cables of the cable unit B.

Wire tie (AB150) : 4 wires

Tightening strength :  $85 \pm 5$  N

Wire tie 1:

10 mm from the cable fixing plate.

Wire tie 2:

Leave 10 mm from the wire tie 1.

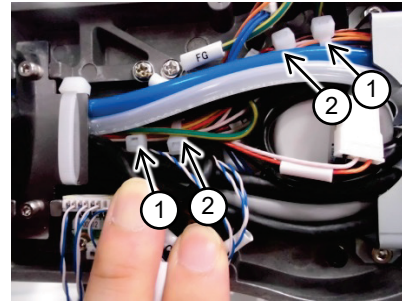

(33) Fix the cable units A and B to the cable fixing plate.

Wire tie (AB200): 3 ties

Tightening strength:  $85 \pm 5$  N

Use the plate shown in the photo.



Twist the cable unit A 180 degrees in the direction indicated with the arrow so that the gray colored cable faces the Arm #3. (See the photo)

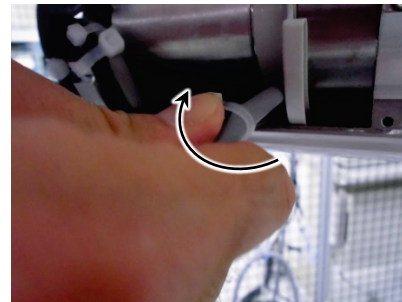

Twist the cable unit B 180 degrees in the direction of the arrow so that the two air tubes face the Arm #3. (See the photo)

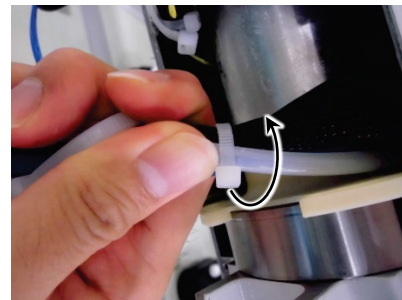



Fix the cable unit A and B to the plate with the wire tie (AB200).

At this point, fix the cable units so that the wire ties are adjacent to the ones binding the cable units A and B. (See the photo)

The wire ties fixing the cable units to the plate should be as close to the ones binding the cables as possible.

The life of the cables may be shorter when the wire ties are separated.

Be careful of positions (indicated with the arrow) of the wire tie heads.

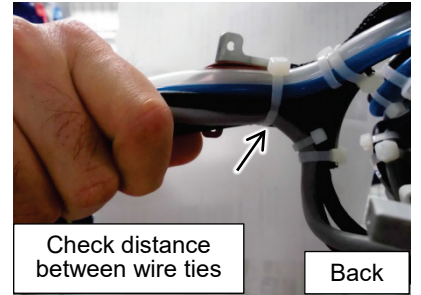
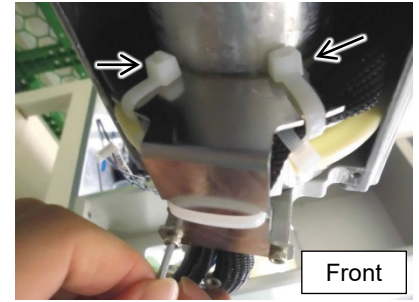

(34) Install the cable fixing plate.

Hexagon socket head cap bolt: 2-M3×6

Tightening torque:  $2.0 \pm 0.1$  N·m

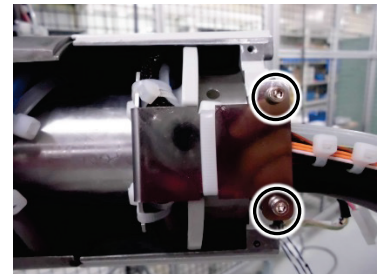

(35) Bind the discrete cables of the cable unit B.

Wire tie (AB150): 2 ties

Tightening strength:  $85 \pm 5$  N

Wire tie 1:

10 mm from the cable fixing plate.

Wire tie 2:

Leave 10 mm from the wire tie 1.

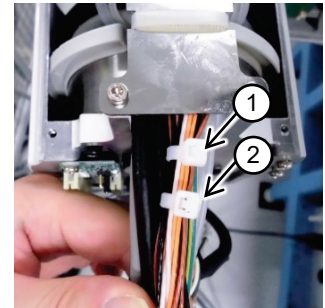

(36) Install the Joint #3 cover.

Cross recessed head screw: 2-M3×12

Tightening torque:  $0.45 \pm 0.05$  N·m

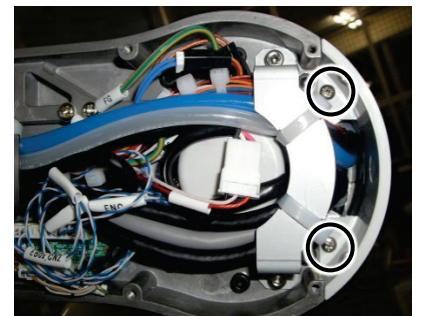

(37) Connect the connectors.

Connector:

PW4, BR4, EB04\_CN3, EB04\_CN1

EB04\_CN3 is the connector for the cable unit “C” in the step (1).

**NOTE** Be careful that the jumper pins on the board do not  
 come off.

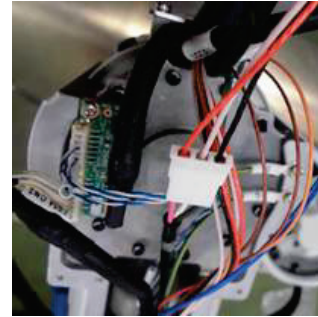

(38) Fix the ground wire. (2 wires)

Cross recessed head screw: 2-M4×6

Tightening torque:  $0.6 \pm 0.05 \text{ N}\cdot\text{m}$

(39) Fix the cable unit B and C to cable fixing plate with the wire tie.

Wire tie (AB150) : 1 tie

Tightening strength:  $85 \pm 5 \text{ N}$

Then, fix the plate using screws.

Hexagon socket head cap bolt: 2-M3×6

Tightening torque:  $2.0 \pm 0.1 \text{ N}\cdot\text{m}$

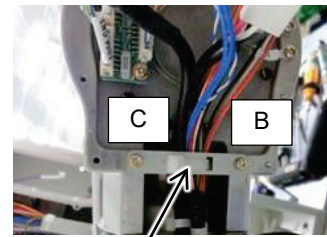

Wire Tie

(40) Install the following connectors and the two air tubes.

Connector: USER1, USER2, X71, X72

Connection point

USER1 → Ether1

USER2 → Ether2

Air tube (white) → Valve 1

Air tube (blue) → Valve 2

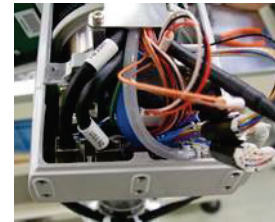

(41) Install the Arm #3 outside cover.

Be careful not to get the cables caught in the cover.

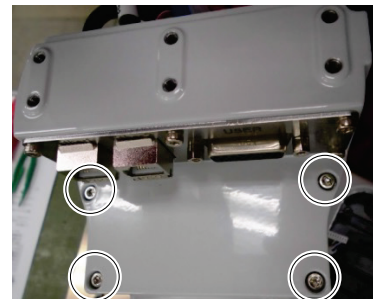

(42) Fix the cable units with the wire ties (4 ties).

Wire tie (AB200) : 2 ties (Arm #3 side)

Wire tie (AB150) : 2 ties (Arm #4 side)

Wire tie fixing strength:  $85 \pm 5\text{N}$

Use wire tie binding the cable unit B and C as a mark for fix position.

Wire tie using as a mark and wire tie fixing on the flange should be as close as possible.

The life of the cables may be shorter when the wire ties are separated.

Be careful of positions of the wire tie heads.

Cut off the wire ties using as a mark after fixing cables on the flange.

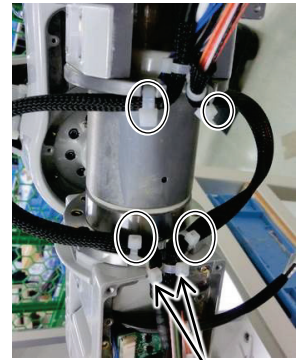

Cut Off

(43) Wipe off the grease which was applied before replacing the cables from the Joint #4 actuator unit.

Apply new grease.

Grease

Krytox : 1 g in total (approximate)

NOTE  Excessive grease increases the possibility of grease leakage from the Manipulator.

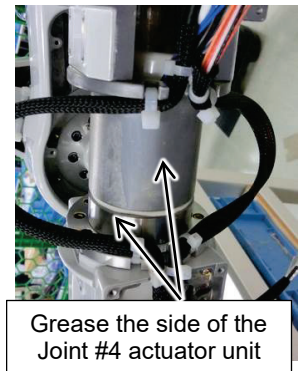

Grease the side of the Joint #4 actuator unit

(44) Fix the ground wire.

Cross recessed head screw: M4×6

Tightening torque:  $0.6 \pm 0.05\text{ N}\cdot\text{m}$

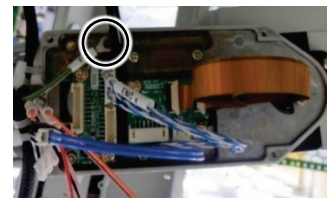

(45) Connect the connectors.

Connector:

PW5, J6P-01, BR5, FL\_CN2, EB05\_CN1

NOTE  Be careful that the jumper pins on the board do not come off.



(46) Install the following covers.

Arm #1 outside cover

Joint #1 cover

For details, refer to *Maintenance 4.4 Replacing the M/C Cable*.

- (47) Pass the cable to the base plate hole and install the base plate.

Hexagon socket head cap bolt: 8-M4×20

Tightening torque:  $5.5 \pm 0.25 \text{ N}\cdot\text{m}$

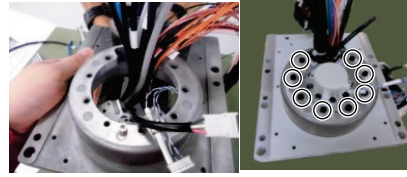

- (48) Fix the cables coming from the Arm #1 to the fixing plate.

Wire tie (AB200): 1 tie

Tightening strength:  $85 \text{ N} \pm 5 \text{ N}$

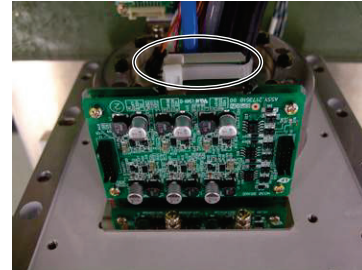

- (49) Fix the user wire plate.

Hexagon socket head cap bolt: 2-M4×8

Tightening torque:  $4.0 \pm 0.2 \text{ N}\cdot\text{m}$

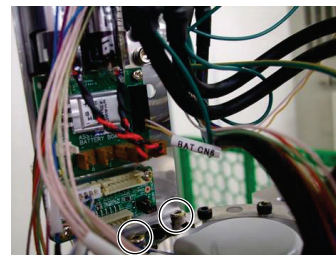

- (50) Install the ground wire terminals.

Hexagon socket head cap bolt: 6-M4×5

Tightening torque:  $4.0 \pm 0.2 \text{ N}\cdot\text{m}$

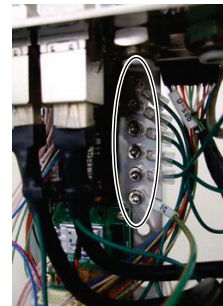

- (51) Install the D-sub connector to the connector indicated as “USER”.



- (52) Install the filter board unit.

Hexagon socket head cap bolt: 2-M4×8

Tightening torque:  $4.0 \pm 0.2 \text{ N}\cdot\text{m}$

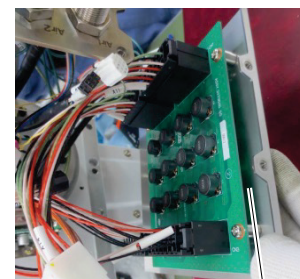

Filter board unit

(53) Install the following connectors and two air tubes.

Connector:

USER1-B, USER2-B, BAT\_CN3, BAT\_CN6,  
EB01\_CN1, EB0x\_CN2, EB01\_CN3, FIL\_CN3,  
FIL\_CN4, PW1, BRK\_CN1, BRK\_CN2,  
BR\_CN3

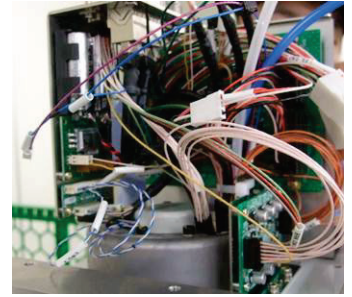

Connection point

USER1-B → Ether1

USER2 -B → Ether2

Air tube (white) → Valve 1

Air tube (blue) → Valve 2

**NOTE**  Be careful that the jumper pins on the board do not come off.

(54) Install the base.

Hexagon socket head cap bolt: 9-M4×8

Tightening torque:  $4.0 \pm 0.2 \text{ N}\cdot\text{m}$

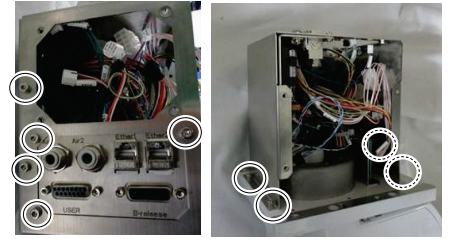

(55) Connect the brake release connector.

**NOTE**  The connector of the connection cable and the adjacent user cable connector have the same shape. Be careful not to connect the wrong connector.



User cable connector

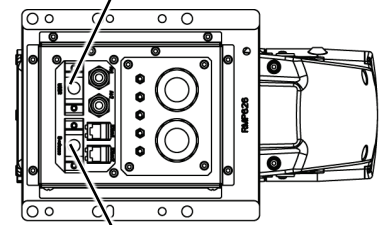

Brake release connector

(56) Install the M/C cable.

For details refer to *Maintenance 4.4 Replacing the M/C Cable*.

(57) Install the base cover.

Cross recessed truss screw: 4-M4×5

Tightening torque:  $0.9 \pm 0.1$  N·m



(58) Install the following covers.

Arm #4 left side cover

Arm #3 side cover

Arm #3 upper cover

Arm #2 inside cover

Joint #2 cover

Arm #1 inside cover

Arm #3 upper side cover

Arm #2 outside cover

Joint #2 outside cover

For details, refer to *Maintenance 3. Covers*.

(59) Perform the calibration.

For details, refer to *Maintenance 8. Calibration*.

(60) During initial operation, excess grease for cables may leak from the space between the Joint #1, #2, #3, and #4 (see the figure below). In that situation, please wipe off the leaked grease.

It is not necessary to apply the additional grease.



NOTE When wiping off the grease, turn OFF the Controller.

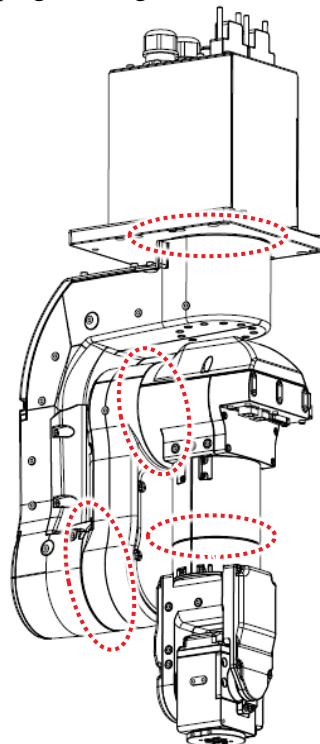

## 4.2 Replacing the Relay Cables



- Before performing any replacement procedure, turn OFF the Controller and related equipment, and then disconnect the power plug from the power source. Performing any replacement procedure with the power ON is extremely hazardous and may result in electric shock and/or malfunction of the robot system.
- Do not connect or disconnect the motor connectors while the power to the robot system is turned ON. Connecting or disconnecting the motor connectors with the power ON is extremely hazardous and may result in serious bodily injury as the Manipulator may move abnormally, and also may result in electric shock and/or malfunction of the robot system.
- Be sure to connect the AC power cable to a power receptacle. DO NOT connect it directly to a factory power source. To shut off power to the robot system, disconnect the power plug from the power source. Performing any work while connecting the AC power cable to a factory power source is extremely hazardous and may result in electric shock and/or malfunction of the robot system.
- Be careful not to get any foreign substances in the Manipulator, connectors, and pins during maintenance. Turning ON the power to the robot system when any foreign substances exist in them is extremely hazardous and may result in electric shock and/or malfunction of the robot system.
- Be sure to connect the cables properly. Do not allow unnecessary strain on the cables. (Do not put heavy objects on the cables. Do not bend or pull the cables forcibly.) Unnecessary strain on the cables may result in damage to the cables, disconnection, and/or contact failure. These are extremely hazardous and may result in electric shock and/or improper function of the robot system.
- When installing the cover, be careful not to allow the cables to interfere with the cover mounting and do not bend these cables forcibly to push them into the cover. Unnecessary strain on cables may result in damage to the cables, disconnection, and/or contact failure. Damaged cables, disconnection, or contact failure is extremely hazardous and may result in electric shock and/or improper function of the robot system.  
When routing the cables, observe the cable locations after removing the cover. Be sure to place the cables back to their original locations.



- When disconnecting the connectors during the replacement of the cable unit, be sure to reconnect the connectors to their proper positions. Improper connection of the connectors may result in improper function of the robot system.  
For details on the connections, refer to the *Maintenance 4.5 Connector Pin Assignments*.



CAUTION

- When installing the cover, be careful not to get the cables caught in it or bend them forcibly to push into the cover.

Unnecessary strain on cables may result in damage to the cables, disconnection, and/or contact failure. These are extremely hazardous and may result in electric shock and/or improper function of the robot system.

When routing the cables, check the cable locations at removing the cover. Be sure to place the cables back to their original locations.



The relay cables (HP\_Harness\_A\_01 to 07) are reusable.

Replace them when the cables or the connector latches are damaged during replacement of the cable unit.

	Name		Quantity	Note
Maintenance Parts	Relay cable	HP Harness A 01	1	2176213
		HP Harness A 02	1	2176214
		HP Harness A 03	1	2176215
		HP Harness A 04	1	2176216
		HP Harness A 05	1	2176217
		HP Harness A 06	1	2176218
		HP Harness A 07	1	2176220
	Wire tie	AB150	-	1675754 1 bag (100 ties: white)
		AB200	-	1684328 1 bag (100 ties: white)
Tools	Hexagonal wrench	width across flats: 2.5 mm	1	For M3 hexagon socket head cap bolts
		width across flats: 3 mm	1	For M4 hexagon socket head cap bolts
		width across flats: 3 mm	1	For M4 hexagon socket head cap bolts, short head
		width across flats: 4 mm	1	For M5 hexagon socket head cap bolts
		width across flats: 5 mm	1	For M6 hexagon socket head cap bolts
	Box wrench	width across flats: 5 mm	1	For D-Sub connector
	Long nose pliers		1	For removing air tubes
	Nippers		1	For cutting a wire tie
	Cross-point screwdriver (#2)		1	For cross recessed head screws
	Torque wrench		1	For tightening torque control
	Cable tie gun		1	Refer: HellermannTyton MK8
	Cable tie gun tester		1	Refer: HellermannTyton DGT500-MK8

### 4.2.1 HP\_Harness\_A\_01

HP\_Harness\_A\_01



#### Removal

- (1) Remove the Arm #4 left side cover.  
For details, refer to *Maintenance 3. Covers*.
- (2) Remove the following connectors.  
Connector: EB05\_CN3, FL01\_CN1

#### Installation

- (1) Check if you have HP\_Harness\_A\_01.
- (2) Install the following connectors.  
Connector: EB05\_CN3, FL01\_CN1
- (3) Install the following connectors.  
Connector: EB05\_CN3, FL01\_CN1
- (4) Calibrate the Joint #6.  
For details, refer to *Maintenance 8. Calibration*.

## 4.2.2 HP\_Harness\_A\_02

HP\_Harness\_A\_02



## Removal

- (1) HP\_Harness\_A\_02 is connected to the actuator unit of each axis.  
Follow the steps according to the unit you are going to replace.

When replacing the Joint #1 actuator unit:

Remove the parts by following the instructions below so that the encoder cover of the Joint #1 actuator unit can be seen.

Reference: *Maintenance 5.1 Replacing the Joint #1 Actuator Unit*

When replacing the Joint #2 actuator unit:

Remove the Joint #2 actuator unit.

Reference: *Maintenance 5.2 Replacing the Joint #2 Actuator Unit*

When replacing the Joint #3 actuator unit:

Remove the Arm #2 outside cover.

Reference: *Maintenance 3. Covers.*

Remove the parts so that the encoder cover of the Joint #3 actuator unit can be seen.

Remove the connector ENCB0x\_CN2 which comes from the Joint #3 actuator unit side.

When replacing the Joint #4 actuator unit:

Remove the Joint #4 actuator unit.

Reference: *Maintenance 5.4 Replacing the Joint #4 Actuator Unit*

When replacing the Joint #5, #6 actuator unit:

Remove the Arm #4 side arm.

Reference: *Maintenance 4.3. Replacing the FPC Unit*

When replacing the Joint #6 actuator unit:

Remove the Arm #5 upper cover and the Arm #5 side cover.

Reference: *Maintenance 3. Covers.*

Remove the connector (ENCB0x\_CN2).

- (2) Remove the encoder cover. (common to all joints)

Cross recessed head screw: 2-M2.5×6

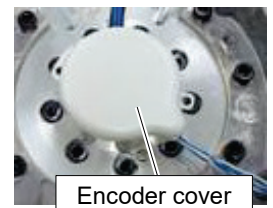

- (3) Remove the connector ENC\_x. (common to all joints)

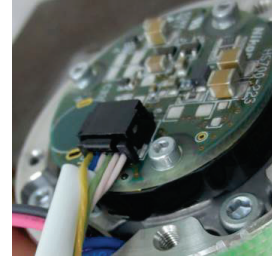

## Installation

- (1) Check if you have HP\_Harness\_A\_02.
- (2) Connect the connector ENC\_x to the encoder.  
(common to all joints)

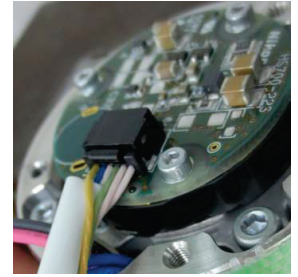

- (3) Install the encoder cover (common to all joints)  
Cross recessed head screw: 2-M2.5×6

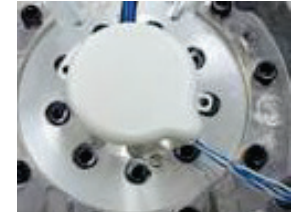

- (4) HP\_Harness\_A\_02 is connected to the actuator unit of each axis.  
Follow the steps according to the unit you are going to replace.

When replacing the Joint #1 actuator unit:

Install the base cover.

Reference: *Maintenance 5.1 Replacing the Joint #1 Actuator Unit*

When replacing the Joint #2 actuator unit:

Install the Joint #2 actuator unit.

Reference: *Maintenance 5.2 Replacing the Joint #2 Actuator Unit*

When replacing the Joint #3 actuator unit:

Connect the connector coming from the Joint #3 actuator unit (ENCB0x\_CN2) to the encoder board 2.

Install the Arm #2 outside cover.

Reference: *Maintenance 3. Covers*

When replacing the Joint #4 actuator unit:

Install the Joint #4 actuator unit.

Reference: *Maintenance 5.4 Replacing the Joint #4 Actuator Unit*

When replacing the Joint #5, #6 actuator unit:

Install the Arm #4 side arm.

Reference: *Maintenance 4.3 Replacing the FPC Unit*

When replacing the Joint #5, #6 actuator unit:

Install the Arm #4 side arm.

Reference: *Maintenance 4.3 Replacing the FPC Unit*

When replacing the Joint #6 actuator unit:

Connect the connector (ENCB0x\_CN2) to the FPC board 2.

Install the Arm #5 upper cover and the Arm #5 side cover.

Reference: *Maintenance 3. Covers.*

- (5) Calibrate the joints whose cables were replaced.

For details, refer to *Maintenance 8. Calibration.*

### 4.2.3 HP\_Harness\_A\_03

HP\_Harness\_A\_03



#### Removal

- (1) Remove the filter board unit.

Hexagon socket head cap bolt: 4-M4×8

**NOTE**  The cable is connected to the filter board unit. When removing the cover, be careful not to pull the cable forcibly.

- (2) Remove the following connectors.

Connector: X11, X12, FIL\_CN1

#### Installation

- (1) Check if you have HP\_Harness\_A\_03.

- (2) Connect the following connectors.

Conenctor: X11, X12, FIL\_CN1

- (3) Install the filter board unit.

Hexagon socket head cap bolt: 4-M4×8

Tightening torque:  $4.0 \pm 0.2$  N·m

**NOTE**  Be careful not to get the cables caught in the cover.

#### 4.2.4 HP\_Harness\_A\_04

HP\_Harness\_A\_04

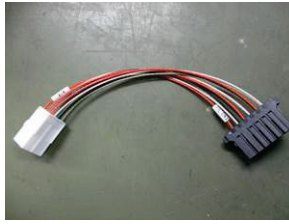

#### Removal

- (1) Remove the filter board unit.

Hexagon socket head cap bolt: 4-M4×8

**NOTE**  The cable is connected to the filter board unit. When removing the cover, be careful not to pull the cable forcibly.

- (2) Remove the following connectors.

Connector: X14, FIL\_CN2

#### Installation

- (1) Check if you have HP\_Harness\_A\_04.

- (2) Connect the following connectors.

Connector: X14, FIL\_CN2

- (3) Install the filter board unit.

Hexagon socket head cap bolt: 4-M4×8

Tightening torque:  $4.0 \pm 0.2$  N·m

**NOTE**  Be careful not to get the cables caught in the cover.

#### 4.2.5 HP\_Harness\_A\_05

HP\_Harness\_A\_05



#### Removal

- (1) Remove the base cover.  
For details, refer to *Maintenance 3. Covers*.
- (2) Remove the D-sub connector on the B-release side.
- (3) Remove the following connectors.  
Connector: LED, BR010, BR\_CN3, BRK\_CN1

#### Installation

- (1) Check if you have HP\_Harness\_A\_05.
- (2) Install the D-sub connector to the B-release side.
- (3) Install the following connectors.  
Connector: LED, BR010, BR\_CN3, BRK\_CN1
- (4) Install the base cover.  
For details, refer to *Maintenance 3. Covers*.



#### 4.2.6 HP\_Harness\_A\_06

HP\_Harness\_A\_05



##### Removal

- (1) Remove the Arm #5 side cover.

For details, refer to *Maintenance 3. Covers*.

- (2) Remove the following connectors.

Connector: BR6, FL\_CN2

##### Installation

- (1) Check if you have HP\_Harness\_A\_06.

- (2) Install the following connectors.

Connector: BR6, FL\_CN2

- (3) Install the Arm #5 side cover.

For details, refer to *Maintenance 3. Covers*.

### 4.2.7 HP\_Harness\_A\_07

HP\_Harness\_A\_05

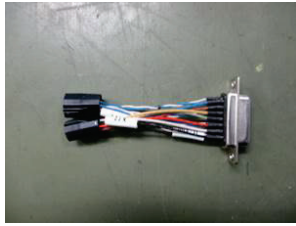

#### Removal

- (1) Remove the Arm #3 outside cover.

For details, refer to *Maintenance 3. Covers*.

- (2) Remove the following connectors.

Connector: X71, X72

- (3) Remove the D-sub connector.

#### NOTE



After removing the D-sub connector, keep the D-sub fixing plate not to lose it.

#### Installation

- (1) Check if you have HP\_Harness\_A\_07.

- (2) Install the D-sub connector.

NOTE The attached nut and washer are not used. Please dispose of them.



Use the D-sub fixing plate.

- (3) Connect the following connectors.

Connector: X71, X72

- (4) Install the Arm #3 outside cover.

For details, refer to *Maintenance 3. Covers*.

### 4.3 Replacing the FPC Unit



- Before performing any replacement procedure, turn OFF the Controller and related equipment, and then disconnect the power plug from the power source. Performing any replacement procedure with the power ON is extremely hazardous and may result in electric shock and/or malfunction of the robot system.
- Do not connect or disconnect the motor connectors while the power to the robot system is turned ON. Connecting or disconnecting the motor connectors with the power ON is extremely hazardous and may result in serious bodily injury as the Manipulator may move abnormally, and also may result in electric shock and/or malfunction of the robot system.
- Be sure to connect the AC power cable to a power receptacle. DO NOT connect it directly to a factory power source. To shut off power to the robot system, disconnect the power plug from the power source. Performing any work while connecting the AC power cable to a factory power source is extremely hazardous and may result in electric shock and/or malfunction of the robot system.
- Be careful not to get any foreign substances in the Manipulator, connectors, and pins during maintenance. Turning ON the power to the robot system when any foreign substances exist in them is extremely hazardous and may result in electric shock and/or malfunction of the robot system.
- Be sure to connect the cables properly. Do not allow unnecessary strain on the cables. (Do not put heavy objects on the cables. Do not bend or pull the cables forcibly.) Unnecessary strain on the cables may result in damage to the cables, disconnection, and/or contact failure. These are extremely hazardous and may result in electric shock and/or improper function of the robot system.
- When installing the cover, be careful not to allow the cables to interfere with the cover mounting and do not bend these cables forcibly to push them into the cover. Unnecessary strain on cables may result in damage to the cables, disconnection, and/or contact failure. Damaged cables, disconnection, or contact failure is extremely hazardous and may result in electric shock and/or improper function of the robot system.  
When routing the cables, observe the cable locations after removing the cover. Be sure to place the cables back to their original locations.



- When disconnecting the connectors during the replacement of the cable unit, be sure to reconnect the connectors to their proper positions. Improper connection of the connectors may result in improper function of the robot system.  
For details on the connections, refer to the *Maintenance 4.5 Connector Pin Assignments*.



CAUTION

- When installing the cover, be careful not to get the cables caught in it or bend them forcibly to push into the cover.

Unnecessary strain on cables may result in damage to the cables, disconnection, and/or contact failure. These are extremely hazardous and may result in electric shock and/or improper function of the robot system.

When routing the cables, check the cable locations at removing the cover. Be sure to place the cables back to their original locations.

	Name	Quantity	Note
Maintenance Parts	FPC unit	1	1696704
Tools	Hexagonal wrench (width across flats: 2.5 mm)	1	For M3 hexagon socket head cap bolts
	Long nose pliers	1	For removing air tubes
	Cross-point screwdriver (#2)	1	For cross recessed head screws
	Torque wrench	1	For tightening torque control

## Removal

- (1) Turn OFF the Controller.
- (2) Remove the following covers.
  - Arm #5 side cover
  - Arm #4 left side cover
  - Arm #3 side cover

For details, refer to *Maintenance 3. Covers*.

- (3) Remove the following connectors.

## Connector:

- PW5 (Joint #5 power cable)
- J6P\_01 (FPC power connector)
- BR5 (Joint #5 brake)
- EB05\_CN1 (encoder board)
- FL\_CN2 (FPC board)
- FL01\_CN1 (FPC board)
- EB05\_CN3 (encoder board)
- EB0x\_CN2 (Joint #5 encoder)

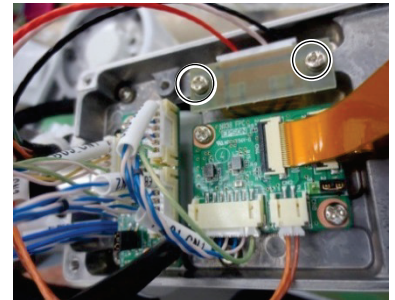

Loosen the screws.  
Cross recessed screw: 2-M3×6

## NOTE

 Be careful that the jumper pins on the board do not come off.

- (4) Remove the encoder board.  
Cross recessed screw: 2-M3×6

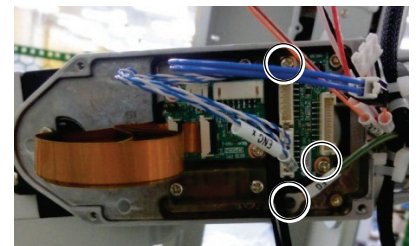

- (5) Remove the ground wire.  
Cross recessed screw: M4×6

- (6) Remove the FPC board.  
Cross recessed screw: 2-M3×6

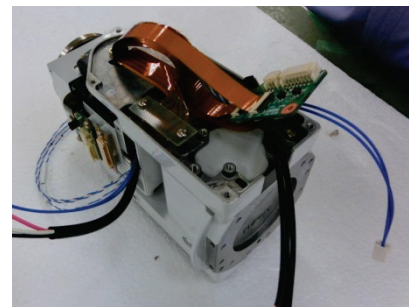

- (7) Remove the FPC power connector.  
Cross recessed screw: 2-M3×6

- (8) Remove all FPC connectors to the FPC board.

Lift up the black latch to remove the connector easily.

**NOTE** Do not pull the FPC forcibly.  
 It may cause damage on the FPC and the board, and may result in electric shock and/or malfunction of the robot system.

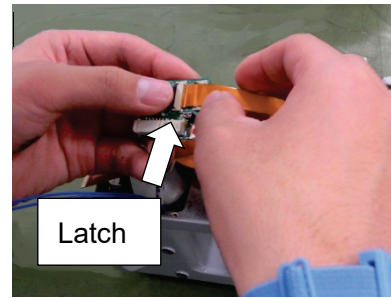

- (9) Remove the bolts fixing the Arm #4 side arm.

Hexagon socket head cap bolt: 4-M3×8

- (10) Remove the bolts fixing the support for FPC.

Hexagon socket head cap bolt: 2-M3×6

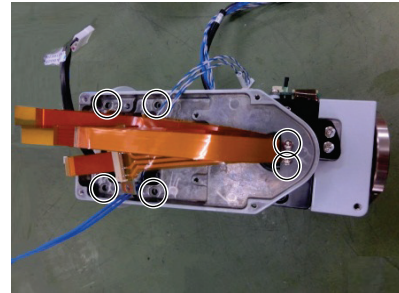

- (11) Remove the FPC from the Arm #4 side arm.

Fold the FPC power connector in order to pass through the hole.

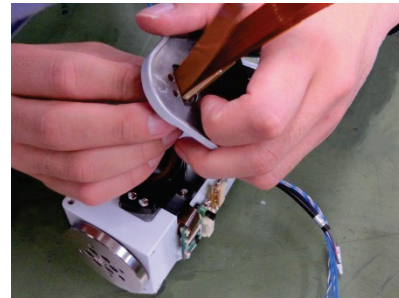

- (12) Remove the FPC guide.

Cross recessed screw: 2-M3×12

- (13) Remove the FPC case.

Cross recessed screw: 4-M3×6



- (14) Remove the connectors connected to the FPC board and the FPC power connector of the Arm #5.

FPC power connector  
 EB0x\_CN2 (Joint #6 encoder)  
 FL\_CN2 (Joint #6 brake)

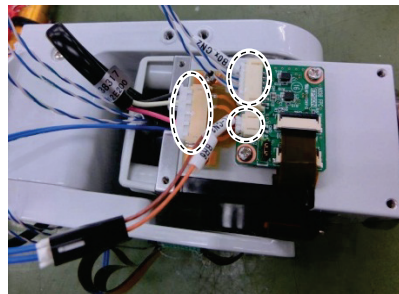

(15) Remove the FPC board from the Arm #5.

Cross recessed screw: 2-M3×6

(16) Remove the FPC power cable from the Arm #5.

Cross recessed screw: 2-M3×6

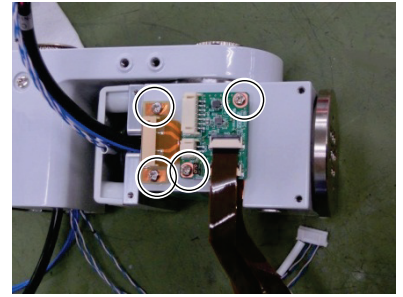

(17) Remove all FPC (5 pcs) connected to the FPC board.

Lift up the black latch to remove the connector easily.

**NOTE** Do not pull the FPC forcibly.  
 It may cause damage on the FPC and the board, and may result in electric shock and/or malfunction of the robot system.

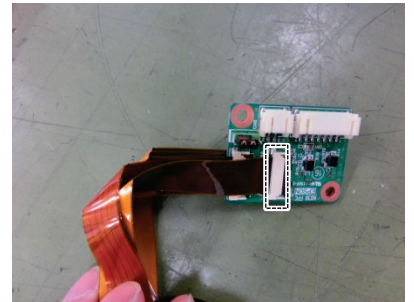

Installation

- (1) Turn OFF the Controller.
- (2) Check the installation direction of the FPC unit.  
The FPC coming from the upper part of the FPC case is for the Arm #4, and the one coming from the side of the FPC case is for the Arm #5.

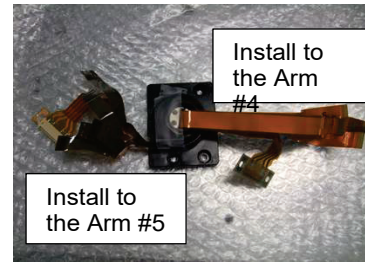

**NOTE** The FPC unit is fixed by tape with FPC stored in the FPC case. Do not remove the tape until the Arm #4 side arm is installed to keep FPC stored in the case.

- (3) Install the FPC to the FPC board of the Arm #5.  
Layer the FPC on top of one another so that the black parts come to the back side of the board (where two connectors are located). See the photo for the installation order of FPC.

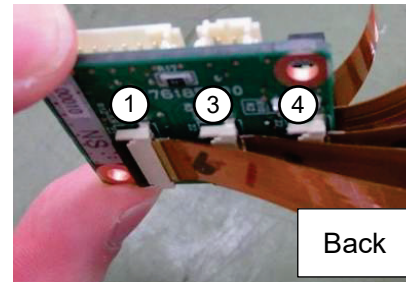

Insert the FPC with the black latch lifted up, and then lower the latch to fix it.

**NOTE** Connect the FPC correctly.  
Operating the Manipulator with incorrect connection may cause malfunction.

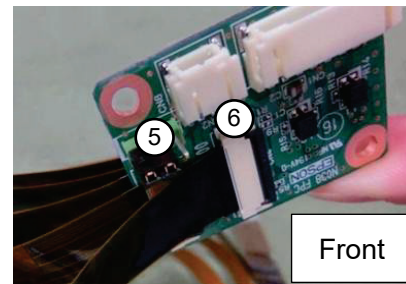

Insert the FPC connectors firmly to the end.

- (4) Install the FPC power connector to the Arm #5.  
Cross recessed screw 2-M3×6  
Tightening torque: 0.3±0.05 N·m  
Make sure that the orange part of FPC is facing the front side.

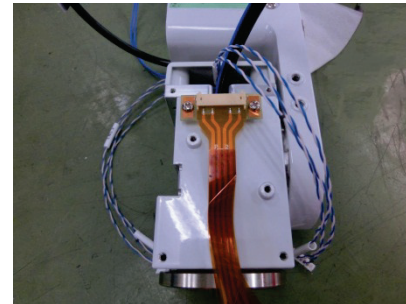

- (5) Install the FPC board with the FPC to the Arm #5.  
Cross recessed screw: 2-M3×6  
Tightening torque: 0.45±0.05N·m

**NOTE** Layer the FPC on top of one another so that the one with the FPC power connector indicated as “2” in the photo comes to the second from the back. If the installation order is incorrect, the FPC will get twisted.

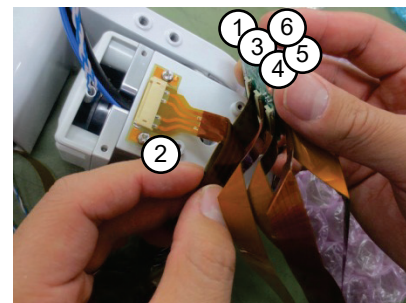



- (6) Fold the FPC one by one, and then put them in layers.

Fold the FPC along the crease one by one.  
Then, layer the folded FPC along the groove.

**NOTE**  If the FPC are folded at once, they may get twisted or it may cause wrong wiring.

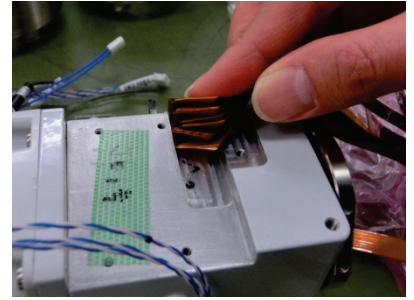

- (7) Align the FPC case to the Arm #5.

While holding the FPC with the FPC case, set the FPC coming from the side of the FPC case along the groove on the case.



Fix the FPC case to the Arm #5.

Cross recessed screw: 4-M3×6

Tightening torque:  $0.45 \pm 0.05\text{N}\cdot\text{m}$

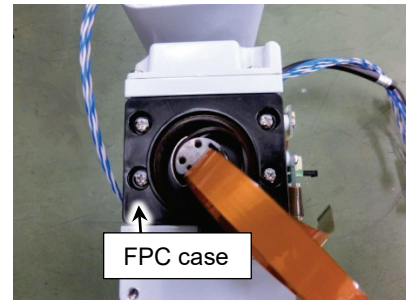

- (8) Install the FPC guide. Make sure that the FPC inside the case do not have deflection.

Cross recessed screw: 2-M3×12

Tightening torque:  $0.45 \pm 0.05\text{N}\cdot\text{m}$

Remove the tape fixing the FPC and the case, and then turn the support fixing the FPC at the center of the case to check if the folded FPC have deflection.

If deflection was found, please contact the supplier of your region.

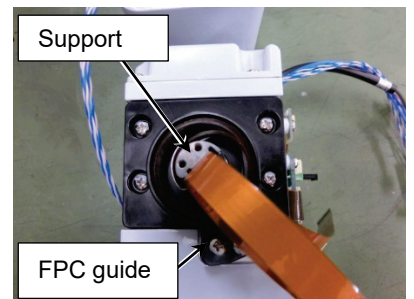

- (9) Pass the FPC to the semicircular hole on the Arm #4 side arm.

Pass the FPC while not applying excessive force to it, and aligning the hole on the support and the installation hole on the Arm #4 side arm.

Pass the FPC which has the power connector so that it has deflection.

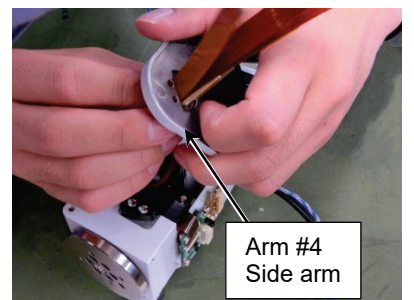

- (10) Pass the three cables coming from the Joint #5 motor unit to the Arm #4 side arm.  
Fix the FPC support to the Arm #4 side arm.  
Hexagon socket head cap bolt: 2-M3×6  
Tightening torque:  $2 \pm 0.1\text{N}\cdot\text{m}$

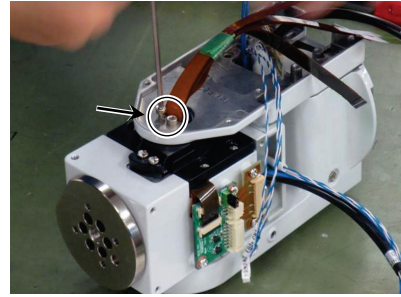

- (11) Install the Arm #4 side arm to the Arm #4.  
Hexagon socket head cap bolt: 4-M3×8  
Tightening torque:  $2 \pm 0.1\text{N}\cdot\text{m}$   
When installing, be careful not to get the cables caught.

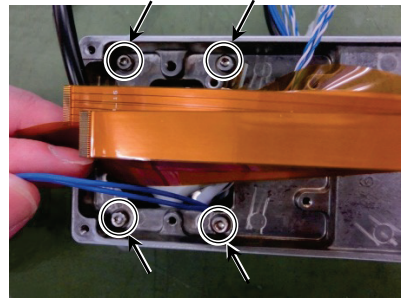

- (12) Connect the FPC to the FPC board of the Arm #4.  
Layer the FPC on top of one another neatly so that the orange parts come to the front side of the board (where two connectors are located). See the photo for the installation order of FPC. (1, 3, and 4 are at the back side of the board)  
Insert the FPC with the black latch lifted up, and then lower the latch to fix it.

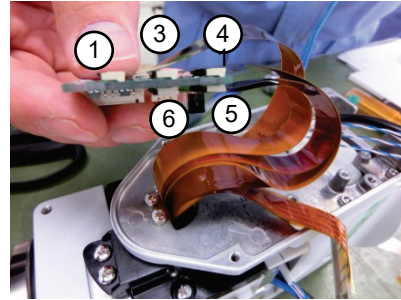

**NOTE**  Connect the FPC correctly.  
Operating the Manipulator with incorrect connection may cause malfunction.

Insert the FPC connectors firmly to the end.

- (13) Install the FPC power connector.  
Install so that the pattern surface of the power connector is facing down and the FPC with the power connector is at the second from the bottom.  
Cross recessed screw: 2-M3×6  
Tightening torque:  $0.45 \pm 0.05\text{N}\cdot\text{m}$

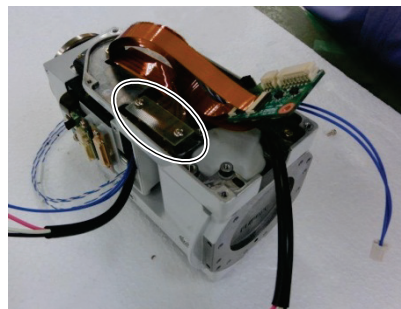

- (14) Install the FPC board.  
Cross recessed screw: 2-M3×6  
Tightening torque:  $0.45 \pm 0.05\text{N}\cdot\text{m}$

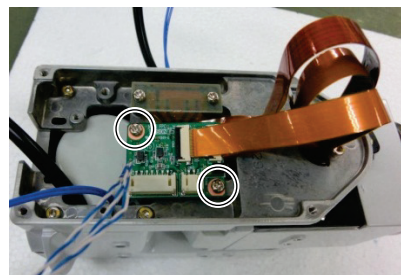

(15) Install the ground wire.

Cross recessed screw: M4×6

Tightening torque:  $0.9 \pm 0.1\text{N}\cdot\text{m}$

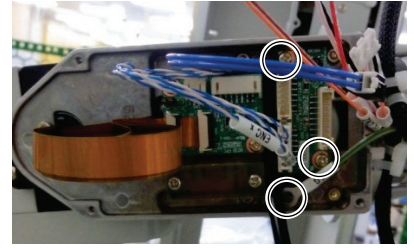

(16) Install the encoder board.

Cross recessed screw: 2-M3×6

Tightening torque:  $0.45 \pm 0.05\text{ N}\cdot\text{m}$

(17) Connect the following connectors inside the Arm #4.

Connector:

- PW5 (Joint #5 power cable)
- J6P\_01 (FPC power connector)
- BR5 (Joint #5 brake)
- EB05\_CN1 (encoder board)
- FL\_CN2 (FPC board)
- FL01\_CN1 (FPC board)
- EB05\_CN3 (encoder board)
- EB0x\_CN2 (Joint #5 encoder)

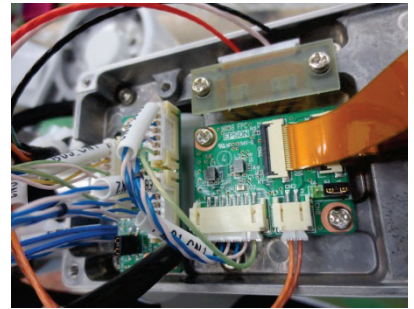

**NOTE**  Be careful that the jumper pins on the board do not come off.

(18) Connect the following connectors inside the Arm #5.

Connector:

- FPC power connector
- EB0x CN2 (Joint #6 encoder)
- FL-CN2 (Joint #6 brake)

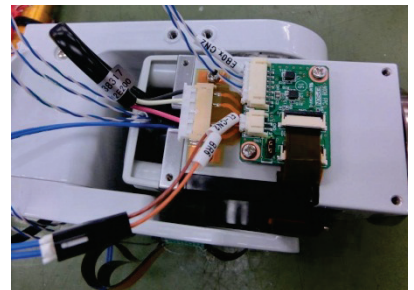

(19) Installing the following covers.

- Arm #5 side cover
- Arm #4 left side cover
- Arm #3 side cover

For details, refer to *Maintenance 3. Covers*.

**NOTE**  When installing the covers, be careful not to get the cables caught in the covers.

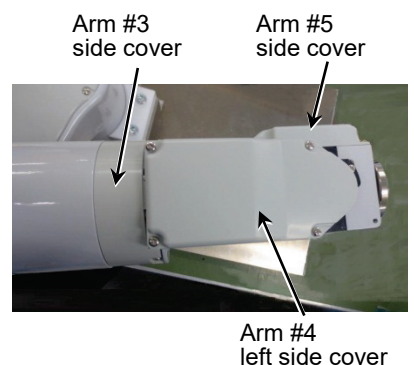

## 4.4 Replacing the M/C Cable



- Before performing any replacement procedure, turn OFF the Controller and related equipment, and then disconnect the power plug from the power source. Performing any replacement procedure with the power ON is extremely hazardous and may result in electric shock and/or malfunction of the robot system.
- Do not connect or disconnect the motor connectors while the power to the robot system is turned ON. Connecting or disconnecting the motor connectors with the power ON is extremely hazardous and may result in serious bodily injury as the Manipulator may move abnormally, and also may result in electric shock and/or malfunction of the robot system.
- Be sure to connect the AC power cable to a power receptacle. DO NOT connect it directly to a factory power source. To shut off power to the robot system, disconnect the power plug from the power source. Performing any work while connecting the AC power cable to a factory power source is extremely hazardous and may result in electric shock and/or malfunction of the robot system.
- Be careful not to get any foreign substances in the Manipulator, connectors, and pins during maintenance. Turning ON the power to the robot system when any foreign substances exist in them is extremely hazardous and may result in electric shock and/or malfunction of the robot system.
- Be sure to connect the cables properly. Do not allow unnecessary strain on the cables. (Do not put heavy objects on the cables. Do not bend or pull the cables forcibly.) Unnecessary strain on the cables may result in damage to the cables, disconnection, and/or contact failure. These are extremely hazardous and may result in electric shock and/or improper function of the robot system.
- When installing the cover, be careful not to allow the cables to interfere with the cover mounting and do not bend these cables forcibly to push them into the cover. Unnecessary strain on cables may result in damage to the cables, disconnection, and/or contact failure. Damaged cables, disconnection, or contact failure is extremely hazardous and may result in electric shock and/or improper function of the robot system.  
When routing the cables, observe the cable locations after removing the cover. Be sure to place the cables back to their original locations.



CAUTION

- When disconnecting the connectors during the replacement of the cable unit, be sure to reconnect the connectors to their proper positions. Improper connection of the connectors may result in improper function of the robot system. For details on the connections, refer to *Maintenance 4.5 Connector Pin Assignment*.
- When installing the cover, be careful not to allow the cables to interfere with the cover mounting and do not bend these cables forcibly to push them into the cover. Unnecessary strain on cables may result in damage to the cables, disconnection, and/or contact failure. These are extremely hazardous and may result in electric shock and/or improper function of the robot system. When routing the cables, check the cable locations after removing the cover. Be sure to place the cables back to their original locations.

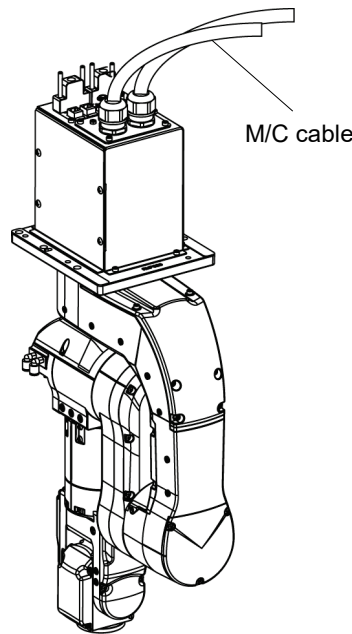

		Name		Quantity	Note
Maintenance Parts	M/C cable	3 m	Straight	1	1696711
			L-shaped	1	1696714
		5 m	Straight	1	1696712
			L-shaped	1	1696715
		10 m	Straight	1	1696713
			L-shaped	1	1696716
		15 m	Straight	1	1745266
			L-shaped	1	1745268
20 m	Straight	1	1745267		
	L-shaped	1	1745269		
Tools	Hexagonal wrench (width across flats: 3 mm)			1	For M4 hexagon socket head cap bolts

Removal

- (1) Turn OFF the Controller power.
- (2) Disconnect the following connectors from the Controller.

Power cable connector

Signal cable connector

- (3) Remove the base cover from the base.

For details, refer to *Maintenance: 3. Covers*.

- (4) Remove the connectors.

Connector: X11, X12, X14, BR010, X010, X020, X040, LED, GS01

NOTE



Each connector is numbered and has a different shape.

Do not disconnect the battery connectors (BAT\_CN3, BAT\_CN6).  
Otherwise, calibration will be required.

For details, refer to *Maintenance: 8. Calibration*.

- (5) Remove the connector sub plate.

For details, refer to *Maintenance: 3. Covers*.

NOTE



Do not remove the M/C cable from the connector plate.

Installation

- (1) Install the connector plate to the base.

For details, refer to *Maintenance: 3. Covers*.

- (2) Connect the connectors of the new M/C cable to these of the cable unit.

Connector: X11, X12, X14, BR010, X010, X020, X040, LED, GS01

- (3) Install the base cover to the base.

For details, refer to *Maintenance: 3. Covers*.

- (4) Connect the following connectors to the Controller.

Power cable connector

Signal cable connector

- (5) Turn ON the Controller power.

- (6) Check operation to see if the Manipulator's position and posture are out of position.  
Move the Manipulator to two or three points (poses) of the registered points.

- (7) If the battery connectors (BAT\_CN3, BAT\_CN6) were disconnected, calibrate all the Joints.

For details, refer to *Maintenance: 8. Calibration*.

- (8) If the Manipulator is off position, calibrate all the joints.

For details, refer to *Maintenance: 8. Calibration*.

## 4.5 Connector Pin Assignment

### 4.5.1 Signal Cable

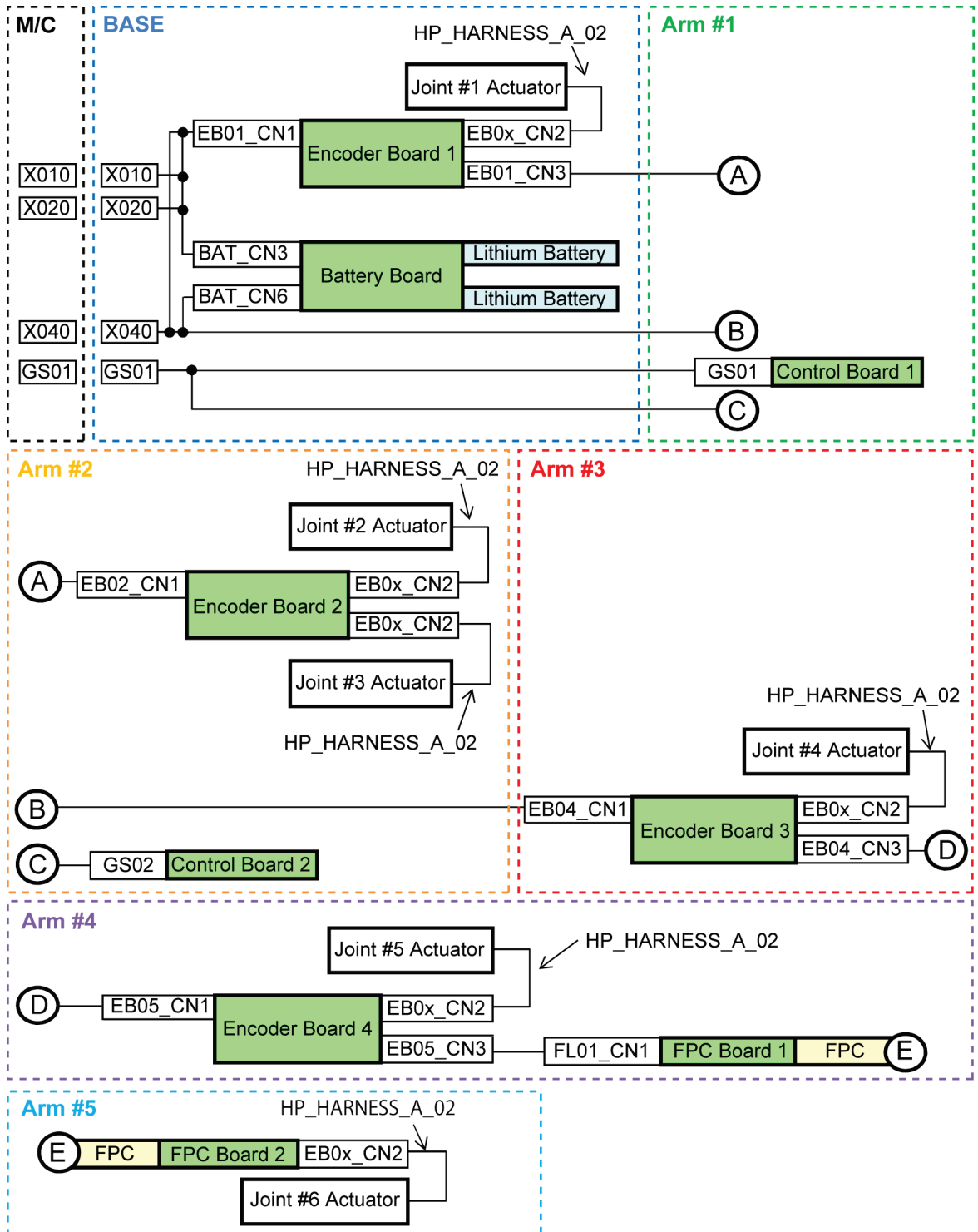

4.5.2 Power Cable

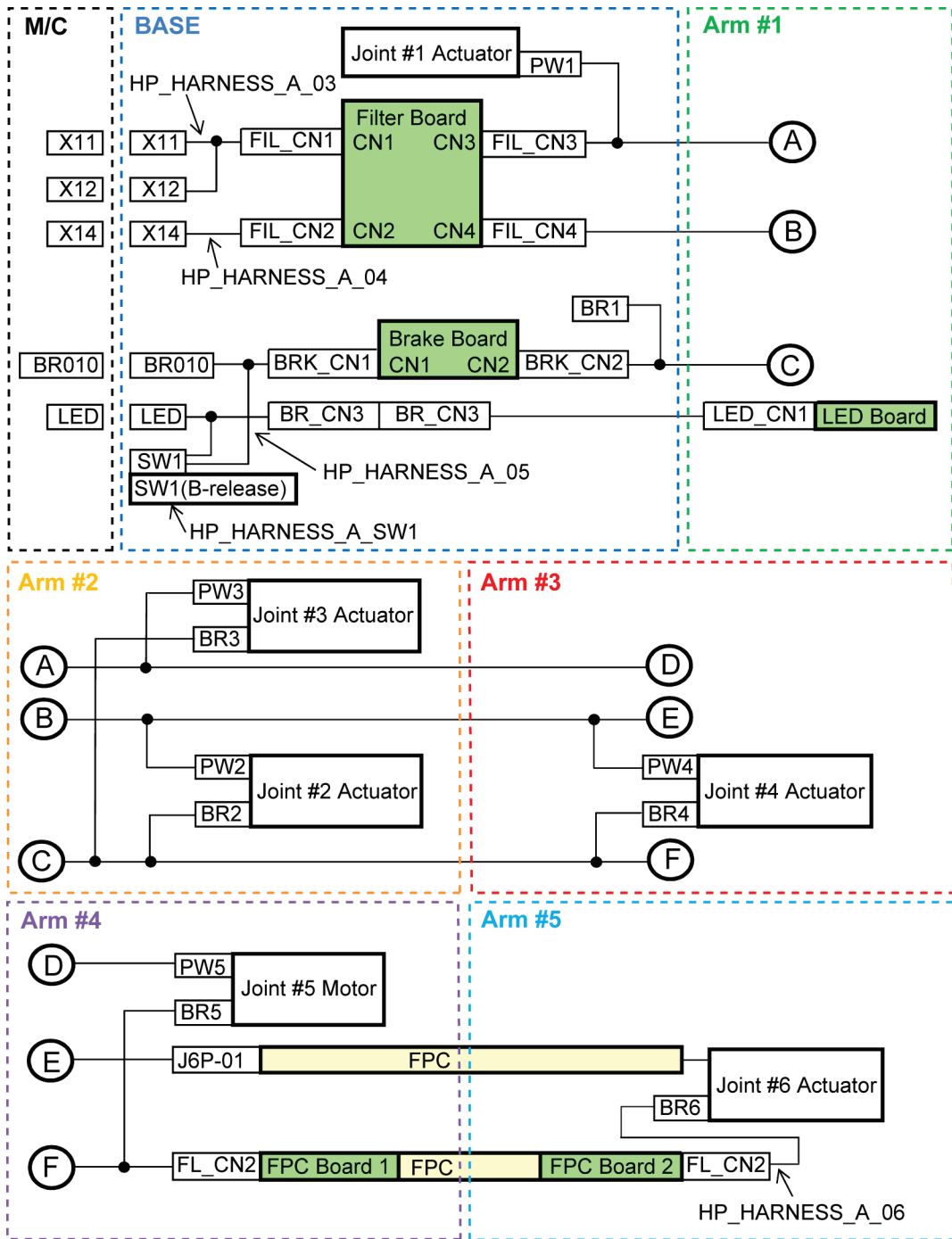



4.5.3 User Cable

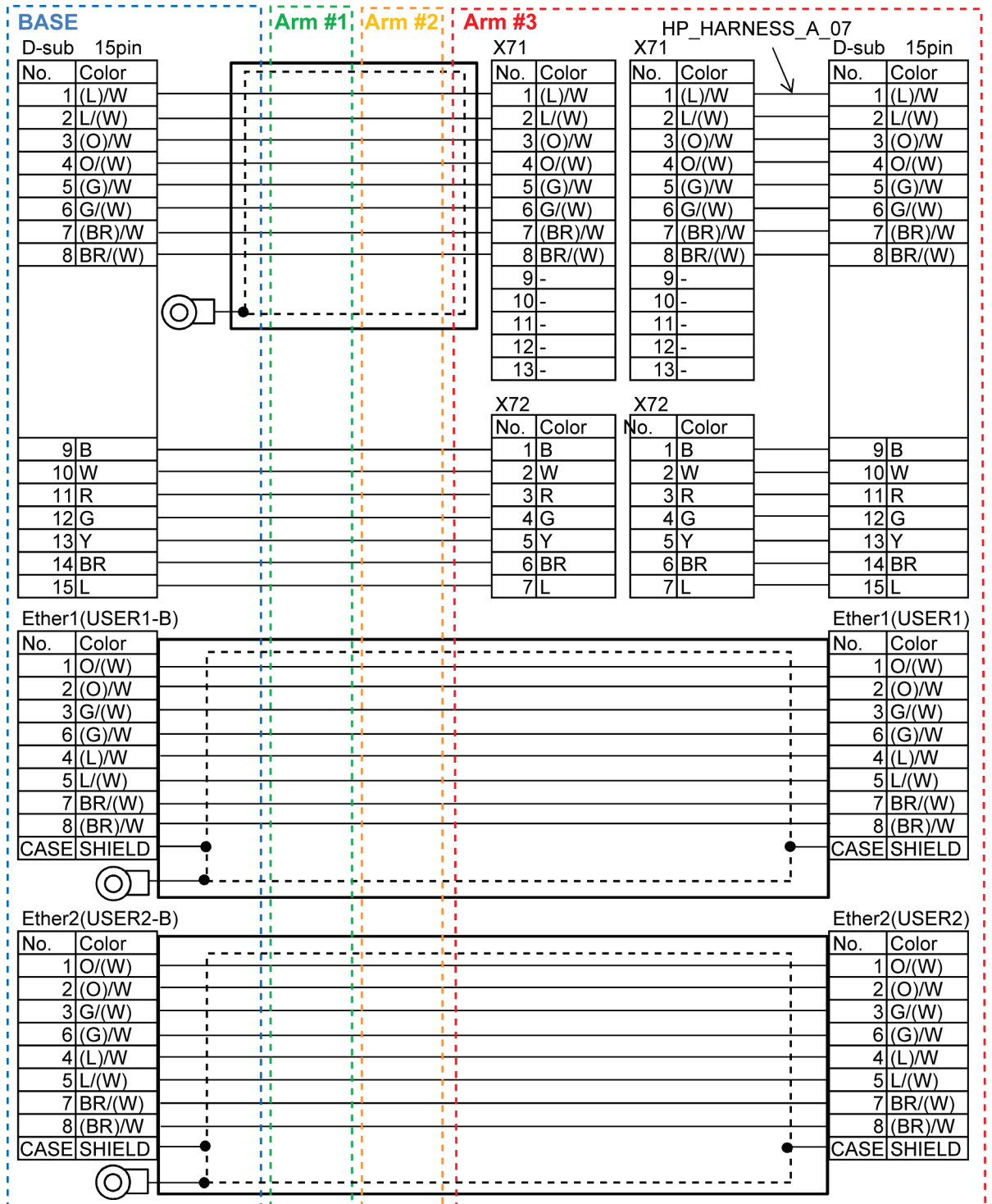

#### 4.5.4 Color of Cables

The following table shows the codes and cable colors indicated in the pin assignments.



4.5.1 Signal Cable

4.5.2 Power Cable

4.5.3 User Cable

Code	Cable color
B	Black
W	White
R	Red
G	Green
Y	Yellow
BR	Brown
L	Blue
V	Violet
A	Azure
O	Orange
GL	Gray
P	Pink

## 5. Actuator Units

 <b>WARNING</b>	<ul style="list-style-type: none"> <li>■ Do not connect or disconnect the motor connectors while the power to the robot system is turned ON. Connecting or disconnecting the motor connectors with the power ON is extremely hazardous and may result in serious bodily injury as the Manipulator may move abnormally, and also may result in electric shock and/or malfunction of the robot system.</li> <li>■ To shut off power to the robot system, disconnect the power plug from the power source. Be sure to connect the AC power cable to a power receptacle. DO NOT connect it directly to a factory power source.</li> <li>■ Before performing any replacement procedure, turn OFF the Controller and related equipment, and then disconnect the power plug from the power source. Performing any replacement procedure with the power ON is extremely hazardous and may result in electric shock and/or malfunction of the robot system.</li> </ul>
 <b>CAUTION</b>	<ul style="list-style-type: none"> <li>■ Be careful not to apply excessive shock to the actuator units and motor shaft during replacement procedures. The shock may shorten the life of the actuator units and motor and/or damage them.</li> <li>■ Never disassemble the parts (units). Disassembled the parts will cause a positional gap and cannot be used again.</li> </ul>

After parts (units) have been replaced, the Manipulator cannot perform positioning properly because a gap exists between the origin stored in the parts and its corresponding origin stored in the Controller.

After replacing the parts, it is necessary to match these origins.

The process of aligning the two origins is called “Calibration”.

Refer to *Maintenance 8. Calibration* and follow the steps to perform calibration.

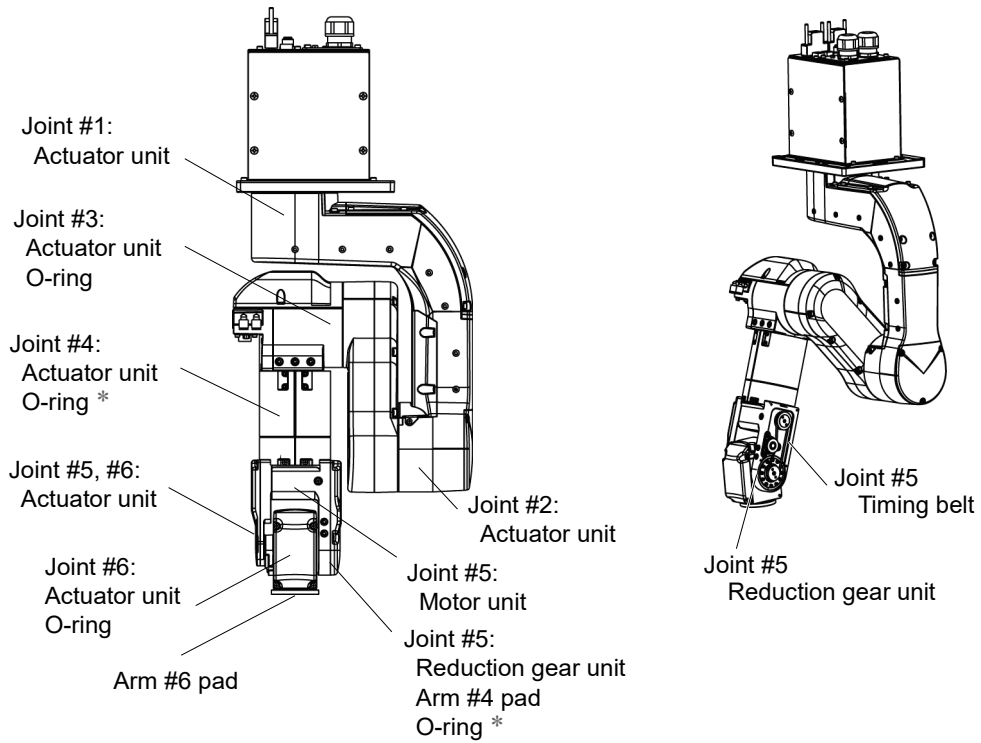

\* : Joint #4 and #5 O rings are common.

NOTE



The Joint #5 is not equipped with the actuator unit. Replace the following parts for each.  
Motor unit, reduction gear unit, timing belt

## 5.1 Replacing the Joint #1 Actuator Unit

 <b>CAUTION</b>	<ul style="list-style-type: none"> <li>■ This procedure has possibility of hands and fingers being caught and/or damage or malfunction to the Manipulator. Be very careful when performing maintenance.</li> <li>■ Before removing the Joint #1 actuator unit, move the Arm #2 about 90 degrees from the origin position. If the Arm #2 is not tilted, the actuator unit cannot be replaced.</li> <li>■ When removing the Arm #1, there must be two or more people to work on it so that at least one of them can support the arm while the others are removing the bolts. Removing the bolts without supporting the arm may result in the arm falling, bodily injury, and/or malfunction of the robot system.</li> </ul>
---	---

	Name		Quantity	Note
Maintenance Parts	Joint #1 actuator unit		1	1696678
	Wire tie (AB200)		-	1684328 : 1 bag (100 ties: white)
Tools	Hexagonal wrench	width across flats: 2.5 mm	1	For M3 hexagon socket head cap bolts
		width across flats: 3 mm	1	For M4 hexagon socket head cap bolts
	Cross-point screwdriver (#2)		1	For cross recessed head screws
	Torque wrench		1	For tightening torque control
	Nippers		1	For cutting the wire ties
	Cable tie gun		1	Refer: HellermannTyton MK8
	Cable tie gun tester		1	Refer: HellermannTyton DGT500-MK8

The Joint #1 is not equipped with the brake. When performing maintenance, be careful not to exceed the motion range of the Joint #1.

Before removing the Joint #1 actuator unit, move the Arm #2 about 90 degrees from the origin position.



Joint #1 Actuator Unit

Removal: Joint #1 Actuator Unit

 <b>CAUTION</b>	<p>■ This procedure has possibility of hands and fingers being caught and/or damage or malfunction to the Manipulator. Be very careful when operating the Manipulator.</p>
---	--

Removal:

- (1) Turn ON the Controller.
- (2) Release the Joint #3 brake.
 

EPSON  
RC+

 Command  
     > brake off, 3
- (3) Tilt the angle of the Arm #2 about 90 degrees from the origin posture.
- (4) Turn OFF the Controller.
- (5) Remove the base cover.
 

For details, refer to *Maintenance 3. Covers*.
- (6) Remove the M/C cable.
 

For details, refer to *Maintenance 4.4 Removing the M/C Cable*.
- (7) Remove the following connectors and two air tubes.

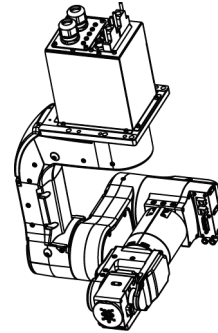

Connector:

USER1-B, USER2-B, BAT\_CN3, BAT\_CN6, EB01\_CN1, EB0x\_CN2, EB01\_CN3, FIL\_CN3, FIL\_CN4, PW1, BR\_CN3

NOTE

Be careful that the jumper pins on the board do not come off.

- (8) Remove the filter board unit.
 

Hexagon socket head cap bolt: 4-M4×8

NOTE

The cables are connected to the filter board unit. When removing the board, be careful not to pull the cables forcibly.

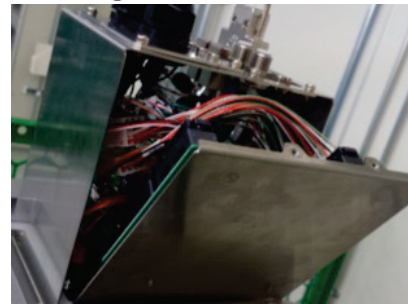
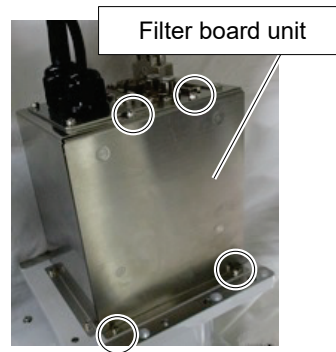

- (9) Remove the connectors connected to the filter board unit.

Connector: FIL\_CN3, FIL\_CN4

(10) Remove the filter board unit.

(11) Remove the D-sub connectors on the cover.

Brake release connector

(12) Remove the D-sub connector from “USER” connector.

User cable connector

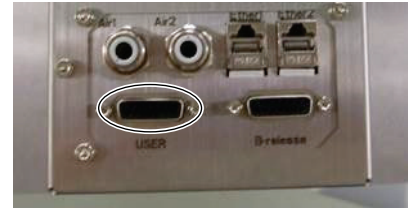

(13) Remove the ground wire terminals.

Hexagon socket head cap bolt: 6-M4×5

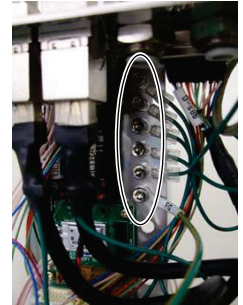

(14) Remove the base.

Hexagon socket head cap bolt: 4-M4×8

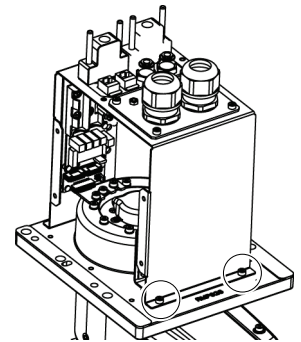

(15) Remove the connectors on the brake board.

Connector: BRK\_CN1, BRK\_CN2

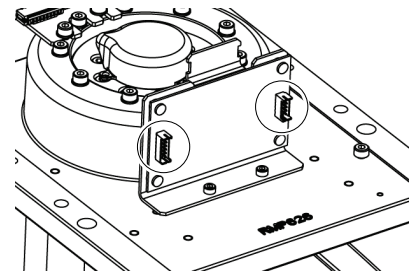

(16) Cut off the wire tie on the brake board plate

**NOTE**  When cutting off the wire tie, be careful not to damage the cables.

Do not cut off of the wire ties other than the one bundling the cables.

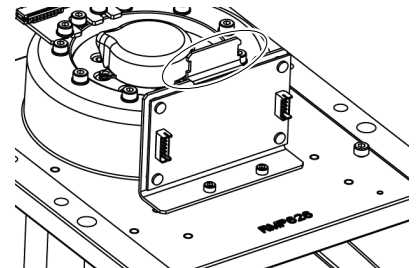

(17) Remove the user wire plate.

Hexagon socket head cap bolt: 2-M4×8

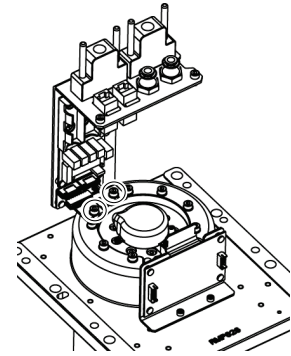

(18) Remove the base from the Joint #1 actuator unit.

Hexagon socket head cap bolt:  
8-M4×20 (with plain washer)

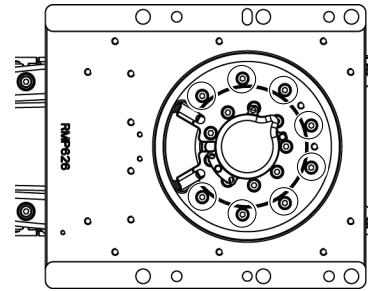

Pull up the base and pass the cable from the base hole to remove.

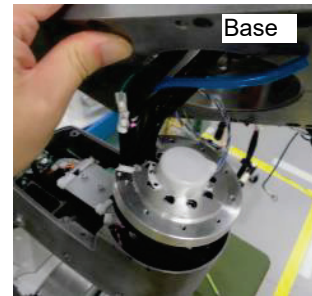

(19) Remove the following covers.

Arm #1 outside cover

Joint #1 cover

For details, refer to *Maintenance 3. Covers*.

(20) Remove the cable fixing plate from the Arm #1.

Hexagon socket head cap bolt: 2-M3×6

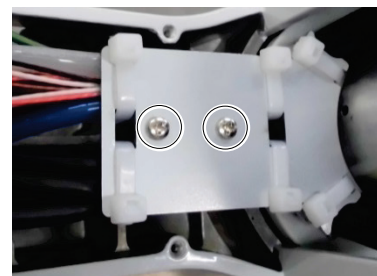

(21) Remove the Joint #1 actuator unit from the Arm #1.

Hexagon socket head cap bolt:  
12-M3×15 (with plain washer)

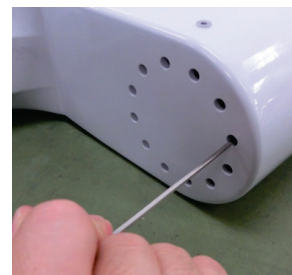



(22) Cut off the wire ties on the flange of the Joint #1 actuator unit to remove the cables.

NOTE  Be careful that the jumper pins on the board do not come off.

When cutting off the wire ties, be careful not to damage the cables.

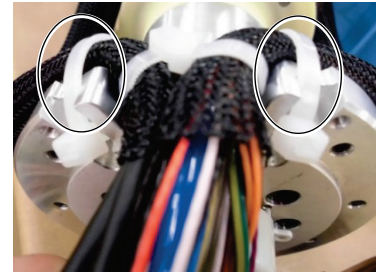

Installation: Joint #1 Actuator Unit

Installation (1) Install the Joint #1 actuator unit to the Arm #1.

Hexagon socket head cap bolt:  
12-M3×15 (with plain washer)

Tightening torque:  $2.4 \pm 0.1$  N·m

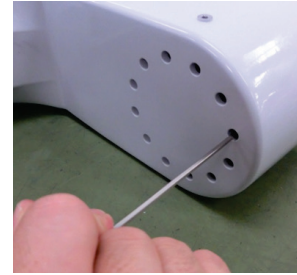

NOTE Apply the grease to the cable contacting part on the actuator unit.



If you wiped off the grease on the base plate and Joint #1, apply the grease to the cable contacting part.

For details, refer to *Maintenance 4.1. Replacing the Cable Unit: Installation (2)*.

Insert the attached O-ring to the groove on the reduction gear unit's circular spline, and then fix the actuator.

Apply a thin coat of grease (SK-1A) to the O-ring.

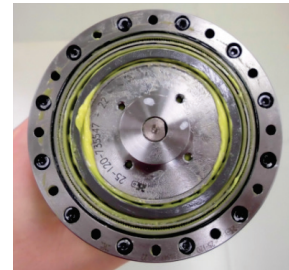

Fix the actuator unit so that the cutout on the white cover of the Joint #1 actuator unit faces the cable fixing plate.



(2) Install the cable fixing plate to the Arm #1.

Hexagon socket head cap bolt:  
2-M3×6 (with plain washer)

Tightening torque:  $2.0 \pm 0.1$  N·m

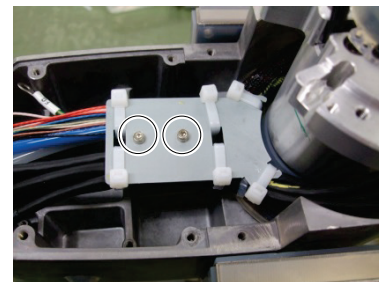

NOTE Install the cables around the Joint #1 actuator unit in U shape.



(3) Install the cables bundled with the wire ties to the Joint #1 actuator unit.

Wire tie: AB200 2ties

Tightening strength:  $85 \pm 5$  N

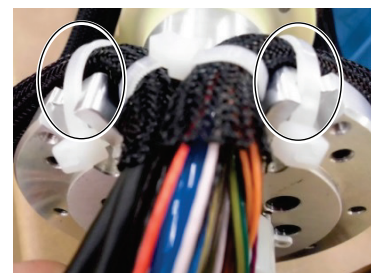

NOTE Install the wire ties according to the marks put in the removal step (22).



The cables need to be twisted 180 degrees.

For details, refer to *Maintenance 4.1 Replacing the Cable Unit: Installation (6), (7)*.

- (4) Install the following covers.

Arm #1 outside cover

Joint #1 cover

For details, refer to *Maintenance 3. Covers*.

- (5) Install the base to the Joint #1 actuator unit.

Hexagon socket head cap bolt:  
8-M4×20 (with plain washer)

Tightening torque:  $5.5 \pm 0.25 \text{ N}\cdot\text{m}$

Mount the base on the Joint #1 actuator unit after passing the cable to the base hole.

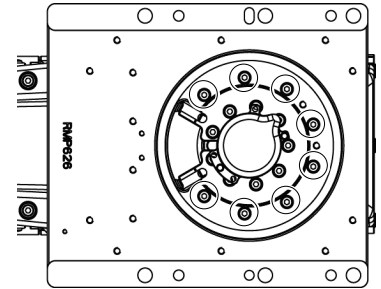

- (6) Install the user wire plate to the base.

Hexagon socket head cap bolt: 2-M4×8

Tightening torque:  $4.0 \pm 0.2 \text{ N}\cdot\text{m}$

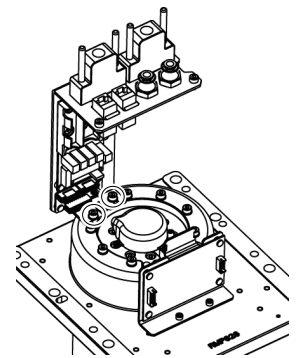

- (7) Bundle the cables coming from the Arm #1 and fix them to the brake board plate with a wire tie.

Wire tie (AB200) 1 tie

Tightening strength:  $85 \pm 5 \text{ N}$

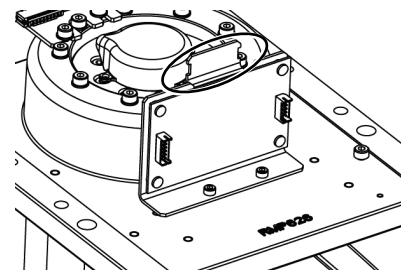

- (8) Connect the following connectors to the brake board.

Connector: BRK\_CN1, BRK\_CN2

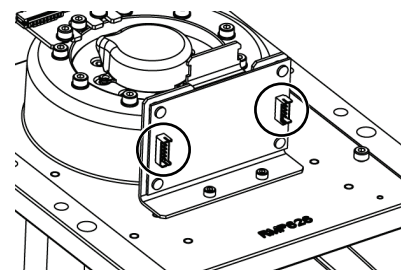

(9) Install the ground wire terminals.

Hexagon socket head cap bolt: 6-M4×5

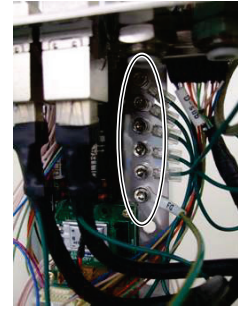

(10) Connect the D-sub connector to “USER”.

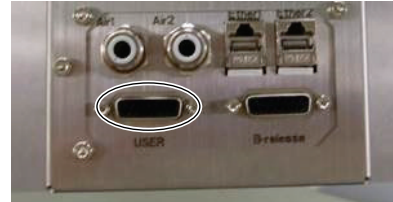

(11) Install the base.

Hexagon socket head cap bolt: 4-M4×8

Tightening torque:  $4.0 \pm 0.2 \text{ N}\cdot\text{m}$

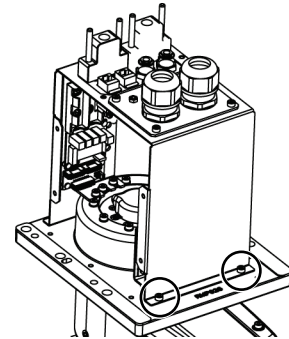

(12) Connect the following connectors to the filter board unit.

Connector: FIL\_CN3, FIL\_CN4

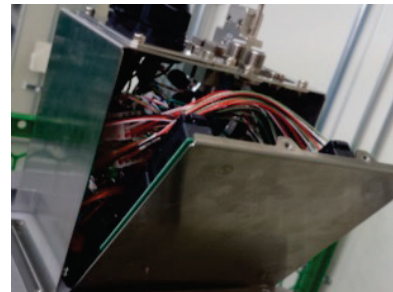

(13) Install the filter board unit.

Hexagon socket head cap bolt: 4-M4×8

Tightening torque:  $4.0 \pm 0.2 \text{ N}\cdot\text{m}$

(14) Connect the following connectors and two air tubes to the base cover from the cover side.

Connector:

USER1-B, USER2-B, BAT\_CN3, BAT\_CN6, EB01\_CN1, EB0x\_CN2,  
EB01\_CN3, PW1, BR\_CN3

NOTE



Be careful that the jumper pins on the board do not come off.

(15) Install the M/C cable.

For details, refer to *Maintenance 4.4 Replacing the M/C Cable*.

(16) Install the base cover.

For details, refer to *Maintenance 3. Covers*.

(17) Connect the following D-sub connectors to the base.

User cable connector

Brake release connector

**NOTE**  The connector of the connection cable and the adjacent user cable connector have the same shape. Be careful not to connect the wrong connector.

## 5.2 Replacing the Joint #2 Actuator Unit

 CAUTION	<ul style="list-style-type: none"> <li>■ This procedure has possibility of hands and fingers being caught and/or damage or malfunction to the Manipulator. Be very careful when performing maintenance.</li> <li>■ Before removing the Joint #2 actuator unit, move the Arms #2 and #3 about 90 degrees from the origin position. If the Arms are not tilted, the actuator unit cannot be replaced.</li> </ul>
--	--

	Name		Quantity	Note
Maintenance Parts	Joint #2 actuator unit		1	1696697
Tools	Hexagonal wrench	width across flats: 2.5 mm	1	For M3 hexagon socket set screws
		width across flats: 3 mm	1	For M4 hexagon socket set screws
	Cross-point screwdriver (#2)		1	For cross recessed head screws
	Torque wrench		1	For tightening torque control

The brake is mounted on each joint to prevent the arm from lowering due to its own weight while the Controller power is OFF or the motor is OFF status. The brake does not work during replacement. Be careful when performing maintenance work.

Before removing the Joint #2 actuator unit, move the Arms #2 and #3 about 90 degrees from the origin position.

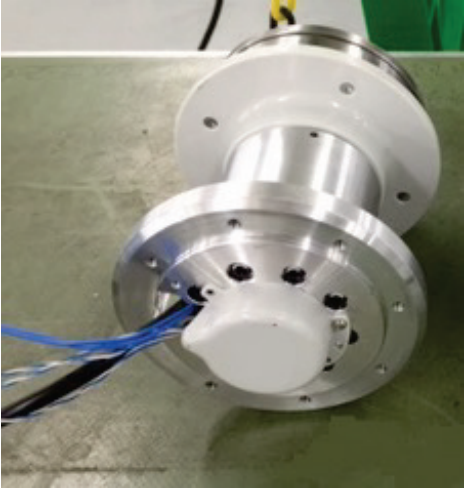

Joint #2 Actuator Unit

## Removal: Joint #2 Actuator Unit



- This procedure has possibility of hands and fingers being caught and/or damage or malfunction to the Manipulator. Be very careful when operating the Manipulator.

## Removal

- (1) Turn ON the Controller.
- (2) Release the Joint #2 and #3 brakes.
 

EPSON  
RC+

 Command
  - > brake off, 2
  - > brake off, 3
- (3) Tilt the angle of the Arms #2 and #3 about 90 degrees from the origin posture.
- (4) Turn OFF the Controller.
- (5) Remove the following covers.

Arm #1 inside cover.

Joint #2 cover    Joint #2 outside cover

Arm #2 outside cover    Arm #2 inside cover

For details, refer to *Maintenance 3. Covers*.

- (6) Remove the cable fixing plate from the Arm #1.

Hexagon socket head cap bolt: 2-M3×6

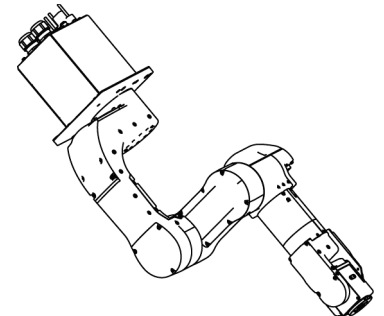

- (7) Remove the ground wire inside the Arm #1.

Ground wire (green/yellow): 1 wire

Cross recessed head screws: M4×6

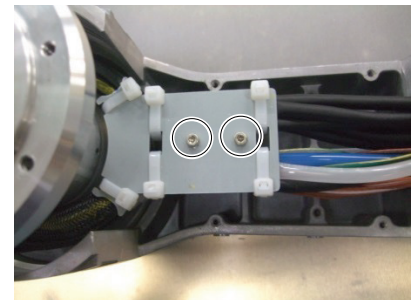

- (8) Remove the following connectors from the Arm #2.

Connector:

EB0C\_CN2 (2 connectors),

EB02\_CN1 (on the encoder board),

PW2, BR2

**NOTE** Be careful not to remove the connectors for the Joint #3 actuator unit.

**NOTE** Be careful that the jumper pins on the board do not come off.

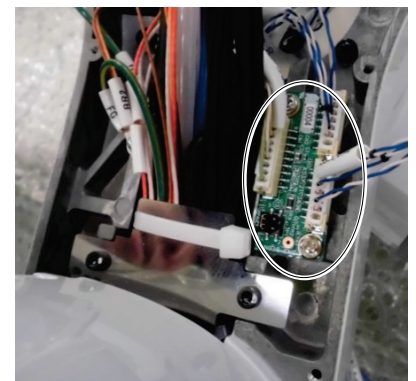

- (9) Remove the ground wires inside the Arm #2.

Ground wire (green/yellow): 2 wire

Cross recessed head screw: 2-M4×6

- (10) Remove the cable fixing plate from the Arm #2.

Hexagon socket head cap bolt: 2-M3×6



- (11) Remove the control board inside the Arm #2.

Cross recessed head screw: 4-M3×6

**NOTE**  The connector (GS02) is connected to the back side of the board. Remove the board slowly, and then remove the connector (GS02).

For details, refer to *Maintenance 7. Boards*.

- (12) Remove the Joint #2 actuator unit from the Arm #2.

Hexagon socket head cap bolt:  
8-M4×20 (with plain washer)

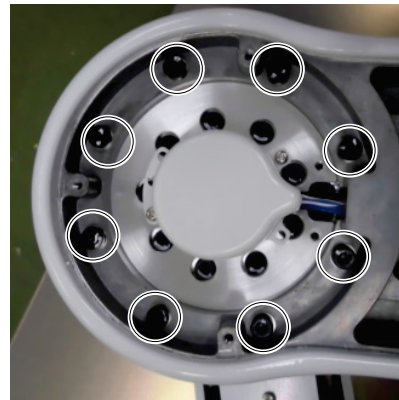
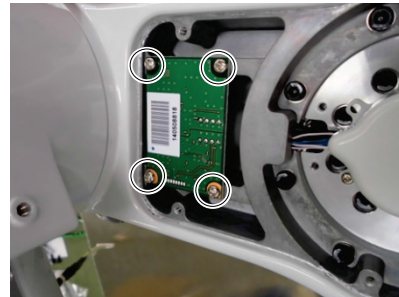

- (13) Remove the Joint #2 actuator unit from the Arm #1.

Hexagon socket head cap bolt:  
12-M3×15

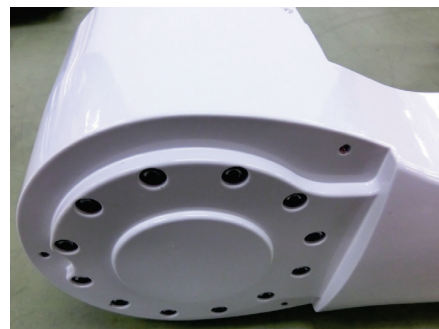



### Installation: Joint #2 actuator unit

#### Installation

- (1) Install the Joint #2 actuator unit to the Arm #2.

Hexagon socket set screw: 12-M3×15

Tightening torque:  $2.4 \pm 0.1$  N·m

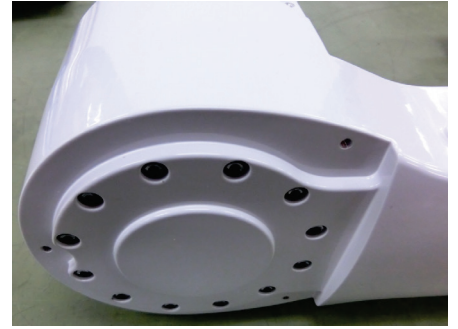



Apply the grease to the cable contacting part on the actuator unit.

If you wiped off the grease on the base plate and Joint #1, apply the grease to the cable contacting parts.

For details, refer to *Maintenance 4.1. Replacing the Cable Unit: Installation (11)*.

**NOTE**  Install the cables around the Joint #2 actuator unit in U shape.

**NOTE**  Insert the attached O-ring to the groove on the reduction gear unit's circular spline, and then fix the actuator.

**NOTE**  Apply a thin coat of grease (SK-1A) to the O-ring.

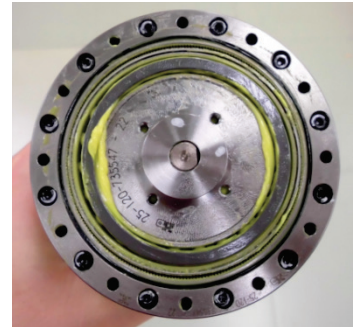

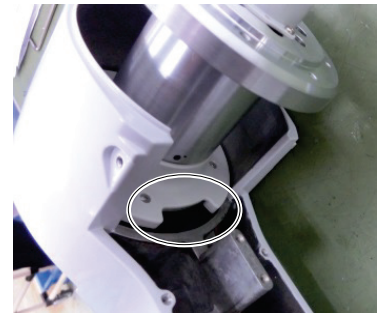

Turn the cutout on the white cover of the Joint #1 actuator unit to face the cable fixing plate and fix the actuator unit.

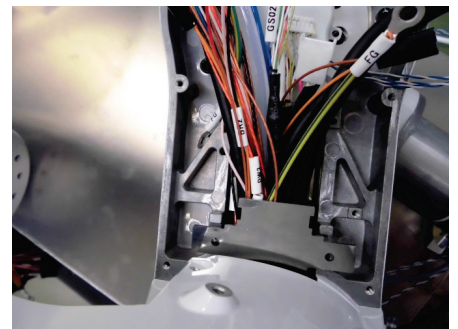

**NOTE**  Set the cable fixing plate to the groove on the installation part, and then install the Arm #2 over the Joint #2 actuator unit while holding the plate by hand.

For details, refer to *Maintenance 4.1. Replacing the Cable Unit: Installation (22) to (24)*.



NOTE  Be careful not to get the cables caught between the Arm #1 and #2.

For details, refer to *Maintenance 4.1. Replacing the Cable Unit: Installation (22) to (24).*

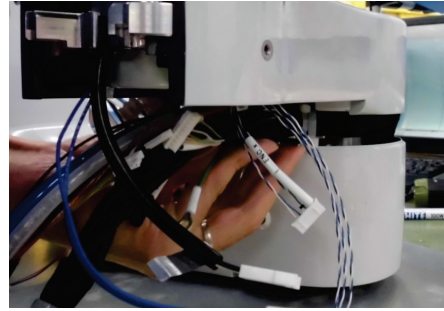

NOTE  Fix the Arm #2 to the Joint #2 actuator unit, while installing the cables coming from the Joint #2 actuator unit along the groove on the Arm #2. (See the photo)

For details, refer to *Maintenance 4.1. Replacing the Cable Unit: Installation (22) to (24).*

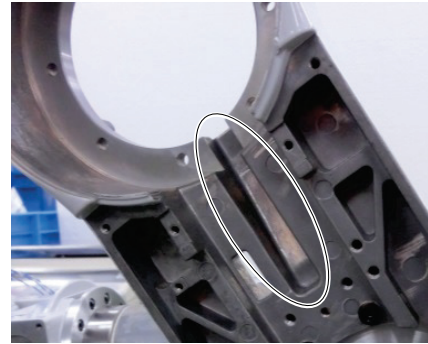

- (2) Install the Joint #2 actuator unit to the Arm #2.

Hexagon socket head cap bolt:  
8-M4×20 (with plain washer)

Tightening torque:  $5.5 \pm 0.25 \text{ N}\cdot\text{m}$

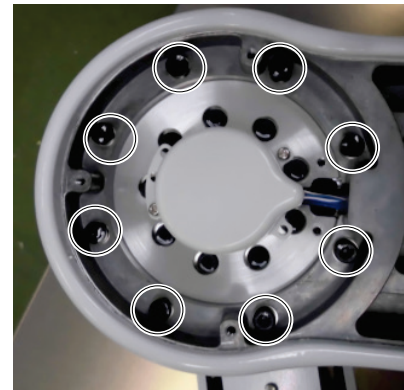

- (3) Mount the control board on the Arm #2.

Cross recessed head screw: 4-M3×6

- (4) Connect next connector on the back side of the board.

Connector: GS02

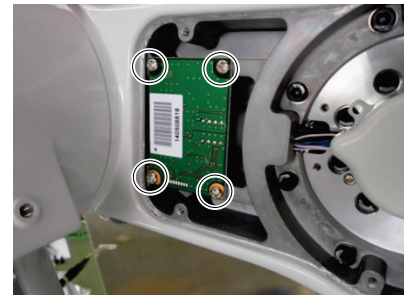

- (5) Install the cable fixing plate to the Arm #2.

Hexagon socket head cap bolt: 2-M3×6

Tightening torque:  $2.0 \pm 0.1 \text{ N}\cdot\text{m}$



- (6) Connect the following connectors inside the Arm #2.

Connector:

EB0C\_CN2 (2 connectors),  
EB02\_CN1 (on the encoder board),  
PW2, BR2

**NOTE**  
 EB0C\_CN2 can be connected to either connector.

**NOTE**  
 Be careful that the jumper pins on the board do not come off.

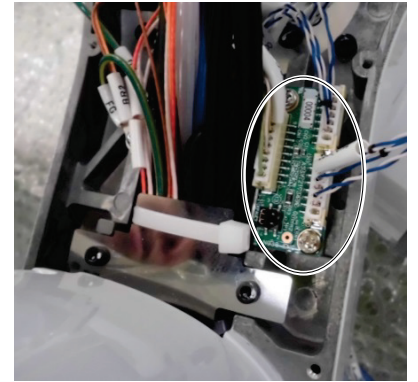

- (7) Install the cable fixing plate to the Arm #2.

Hexagon socket head cap bolt: 2-M3×6  
Tightening torque:  $2.0 \pm 0.1$  N·m

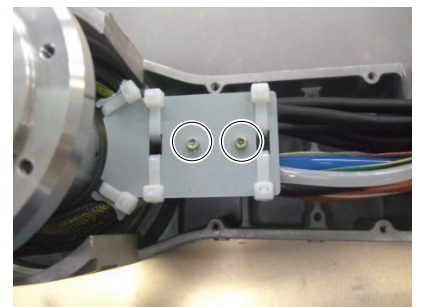

- (8) Install the ground wire inside the Arm #2.

Ground wire (green/yellow) 2 wire  
Cross recessed head screw: 2-M4×6  
Tightening torque:  $0.9 \pm 0.1$  N·m

- (9) Install the ground wire inside the Arm #2.

Ground wire (green/yellow) 1 wire  
Cross recessed head screw: 1-M4×6  
Tightening torque:  $0.9 \pm 0.1$  N·m

- (10) Install the following covers to the Arm #1 and #2.

Arm #1 inside cover.

Joint #2 cover                      Joint #2 outside cover

Arm #2 outside cover    Arm #2 inside cover

For details, refer to *Maintenance 3. Covers*.

**NOTE**  
 When fixing the covers, be careful not to get the cables caught between them.

### 5.3 Replacing the Joint #3 Actuator Unit

 CAUTION	<ul style="list-style-type: none"> <li>■ This procedure has possibility of hands and fingers being caught and/or damage or malfunction to the Manipulator. Be very careful when performing maintenance.</li> <li>■ Before removing the Joint #3 actuator unit, move the Arm #2 about 90 degrees from the origin position.</li> </ul> <p>If the Arm #2 is not tilted, the actuator unit cannot be replaced.</p>
--	--

	Name		Quantity	Note
Maintenance Parts	Joint #3 actuator unit		1	1696698
	Wire tie (AB200)		-	1684328 1 bag (100 ties: white)
Tools	Hexagonal wrench	width across flats: 2.5 mm	1	For M3 hexagon socket set screws
		width across flats: 3 mm	1	For M4 hexagon socket set screws
	Cross-point screwdriver (#2)		1	For cross recessed head screws
	Torque wrench		1	For tightening torque control
	Nippers		1	For cutting the wire ties
	Cable tie gun		1	Refer: HellermannTyton MK8
	Cable tie gun tester		1	Refer: HellermannTyton DGT500-MK8

The brake is mounted on each joint to prevent the arm from lowering due to its own weight while the Controller power is OFF or the motor is OFF status. The brake does not work during replacement. Be careful when performing maintenance work.

Before removing the Joint #3 actuator unit, move the Arm #2 about 90 degrees from the origin position.



Joint #3 Actuator Unit

## Removal: Joint #3 actuator unit



- This procedure has possibility of hands and fingers being caught and/or damage or malfunction to the Manipulator. Be very careful when operating the Manipulator.

## Removal

- (1) Turn ON the Controller.
- (2) Release the Joint #3 brake.
 

EPSON  
RC+

 Command  
> brake off, 3
- (3) Tilt the angle of the Arm #2 about 90 degrees from the origin posture.
- (4) Turn OFF the Controller.
- (5) Remove the Arm #2 outside cover.

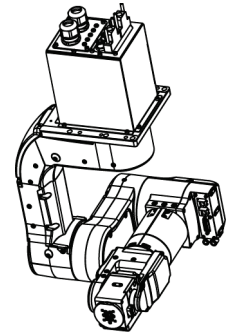

For details, refer to *Maintenance 3. Covers*.

- (6) Remove the following connectors from the Arm #2.

Connector:

- EB0C\_CN2 (2 connectors),
- EB02\_CN1 (on the encoder board),
- PW3, BR3

**NOTE** Be careful not to remove the connectors for the Joint #2 actuator unit.

**NOTE** Be careful that the jumper pins on the board do not come off.



- (7) Remove the cable fixing plate.

Hexagon socket head cap bolt: 2-M4×6

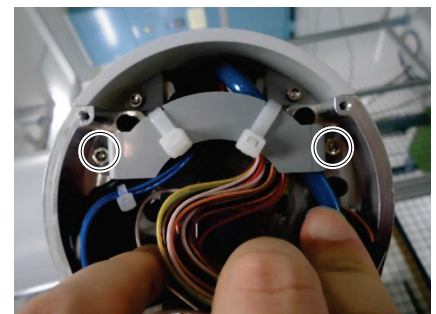

- (8) Remove the following covers.

Joint #3 cover

Arm #3 upper cover.

For details, refer to *Maintenance 3. Covers*.

- (9) Before cutting off the wire ties, put a mark on the surface of cables with a permanent marker so that the fixed positions can be checked later.

Cut off the wire ties on the flange of the Joint #3 actuator unit, and then remove the cables.

**NOTE**  When cutting off the wire tie, be careful not to damage the cables.

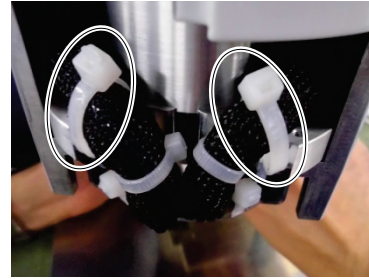

- (10) Remove the cable fixing plate from the Arm #3.

Hexagon socket head cap bolt: 2-M3×6

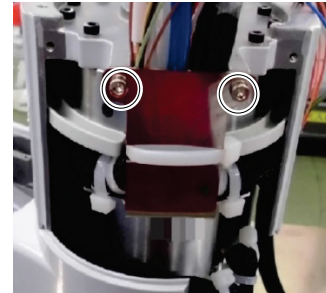

- (11) Remove the Arm #3 outside cover.

Hexagon socket head cap bolt: 4-M3×15

- (12) Remove the connectors and two air tubes from the cover.

Connectors: USER1, USER2, X71, X72

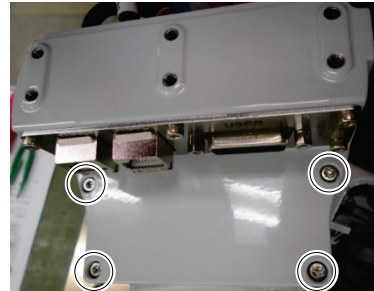

- (13) Remove the encoder board and the ground wires connected to the Arm #3.

Encoder board:

Cross recessed head screw: 2-M3×6

Ground wire (green/yellow) 2 wires

Cross recessed screw: 2-M3×6

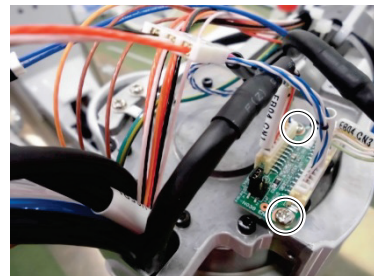

- (14) Remove the Joint #3 actuator unit from the Arm #3.

Hexagon socket head cap bolt:  
12-M3×15 (with plain washer)

NOTE  There is an O-ring between the Arm #3 and the Joint #3 actuator unit.

Remove the O-ring together with the actuator unit.

O-ring: Inner diameter  $\phi$  69.57 mm  
Wire diameter  $\phi$  1.78 mm

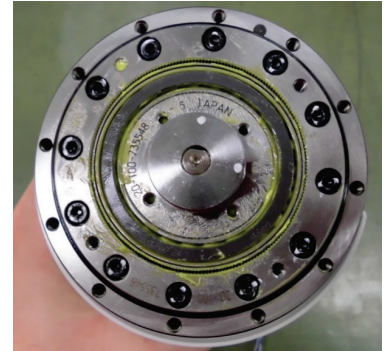
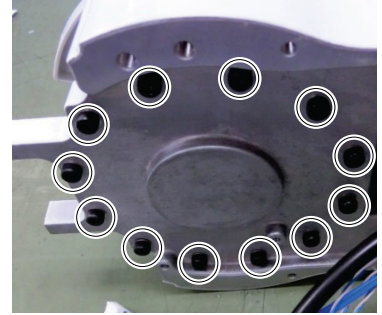

- (15) Remove the Joint #3 actuator unit from the Arm #2.

Hexagon socket head cap bolt:  
8-M4×18 (with plain washer)

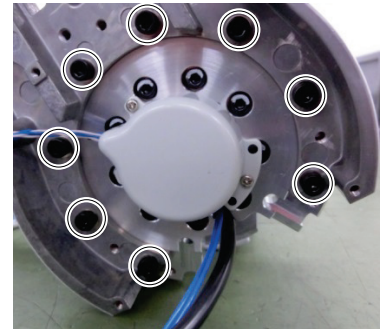

**Installation: Joint #3 actuator unit**

**Installation**

(1) Install the Joint #3 actuator unit to the Arm #2.

Hexagon socket head cap bolt:  
8-M4×18 (with plain washer)

Tightening torque:  $5.5 \pm 0.25$  N·m

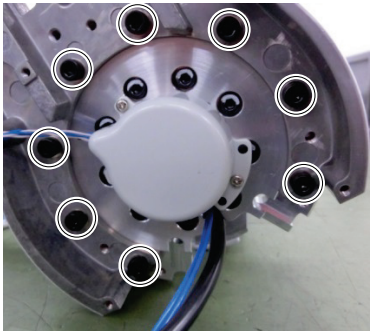

**NOTE**  Be careful of the assembly direction of the Joint #3 actuator unit.

Install the actuator unit so that the cutout on the actuator flange matches the direction of the cutout on the Arm #2.

**NOTE**  Apply the grease to the cable contacting part on the actuator unit.

If you wiped off the grease on the Joint #2 and #3, apply the grease to the cable contacting parts.

For details, refer to *Maintenance 4.1. Replacing the Cable Unit.*

(2) Install the O-ring to the Joint #3 actuator unit.

Install the actuator unit to the Arm #3.

O-ring: Inner diameter  $\phi$  69.57 mm  
Wire diameter  $\phi$  1.78 mm

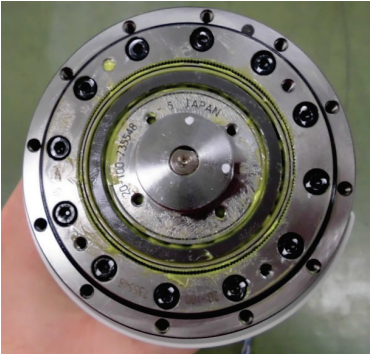

**NOTE**  Apply a thin coat of grease (SK-1A) to the O-ring.

Hexagon socket set screw:  
12-M3×15 (with plain washer)

Tightening torque:  $2.4 \pm 0.1$  N·m

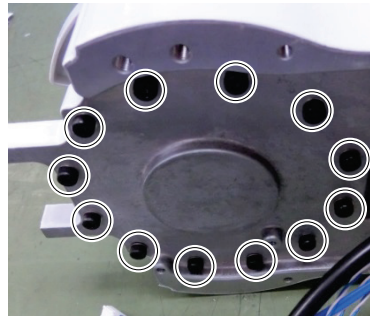

(3) Install the encoder board and the ground wires to the Arm #3.

Encoder board  
Cross recessed screw: 2-M3×6

Ground wire (green/yellow) 2 wires  
Cross recessed screw: 2-M3×6

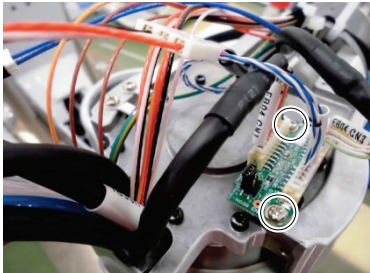



- (4) Install the Arm #3 outside cover.

Hexagon socket head cap bolt: 4-M3×15

Tightening torque:  $2.0 \pm 0.1 \text{ N}\cdot\text{m}$

- (5) Mount the connectors and two air tubes on the cover.

Connectors: USER1, USER2, X71, X72

- (6) Install the cable fixing plate to the Arm #3.  
Pass the cables between the protruding parts.

Hexagon socket head cap bolt: 2-M3×6

Tightening torque:  $2.0 \pm 0.1 \text{ N}\cdot\text{m}$

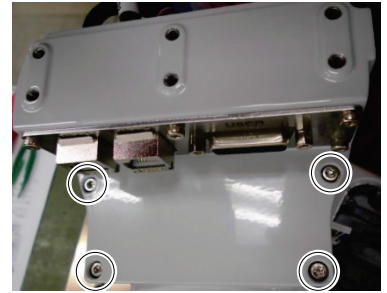

- (7) Fix the cables to the flange of the Joint #3 actuator unit with the wire ties.

Install the cables so that the head parts of the wire ties face the cable fixing plate side on the Arm #3.

Wire tie (AB200) 2 tie

Tightening strength:  $85 \pm 5 \text{ N}$

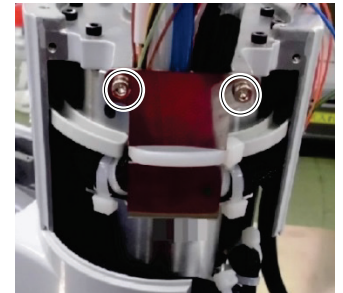

NOTE Install the wire ties according to the marks put in the removal step (8).



Set the cables around the Joint #3 actuator unit in U shape.

The cables need to be twisted 180 degrees.

For details, refer to *Maintenance 4.1. Replacing the Cable Unit: Installation (29), (30)*.

- (8) Install the cable fixing plate to the Arm #2.

Hexagon socket head cap bolt: 2-M4×6

Tightening torque:  $4.0 \pm 0.2 \text{ N}\cdot\text{m}$

- (9) Install the following covers.

Joint #3 cover

Arm #3 upper cover.

For details, refer to *Maintenance 3. Covers*.

NOTE



Be careful not to twist the cables or get them caught in the Arm.

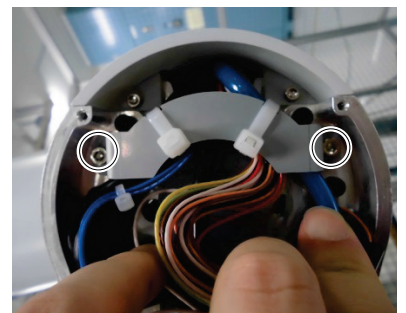

(10) Install the following connectors.

Connector:

EB0C\_CN2 (2 connectors),

EB02\_CN1 (on the encoder board),

PW3, BR3

 NOTE Be careful that the jumper pins on the board do not come off.

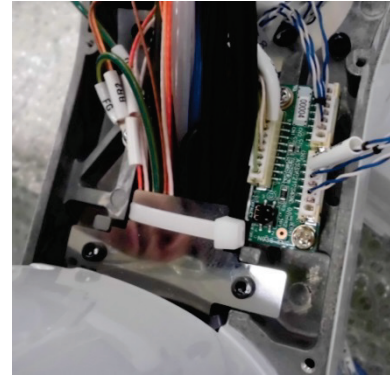

(11) Install the Arm #2 outside cover.

For details, refer to *Maintenance 3. Covers*.

## 5.4 Replacing the Joint #4 Actuator Unit

 <b>CAUTION</b>	<ul style="list-style-type: none"> <li>■ This procedure has possibility of hands and fingers being caught and/or damage or malfunction to the Manipulator. Be very careful when performing maintenance.</li> <li>■ Before removing the Joint #4 actuator unit, move the Arm #3 about 90 degrees from the origin position.</li> </ul> <p>If the Arm is not tilted, the actuator unit cannot be replaced.</p>
---	---

	Name		Quantity	Note
Maintenance Parts	Joint #4 actuator unit		1	1696699
	Wire tie (AB200)		-	1684328 1 bag (100 ties: white)
Tools	Hexagonal wrench	width across flats: 2 mm	1	For M2.5 hexagon socket head cap bolts
		width across flats: 2.5 mm	1	For M3 hexagon socket head cap bolts
	Cross-point screwdriver (#2)		1	For cross recessed head screws
	Nippers		1	For cutting the wire ties
	Cable tie gun		1	Refer: HellermannTyton MK8
	Cable tie gun tester		1	Refer: HellermannTyton DGT500-MK8

The brake is mounted on each joint to prevent the arm from lowering due to its own weight while the

Controller power is OFF or the motor is OFF status. The brake does not work during replacement. Be careful when performing maintenance work.

Before removing the Joint #4 actuator unit, move the Arm #3 about 90 degrees from the origin position.

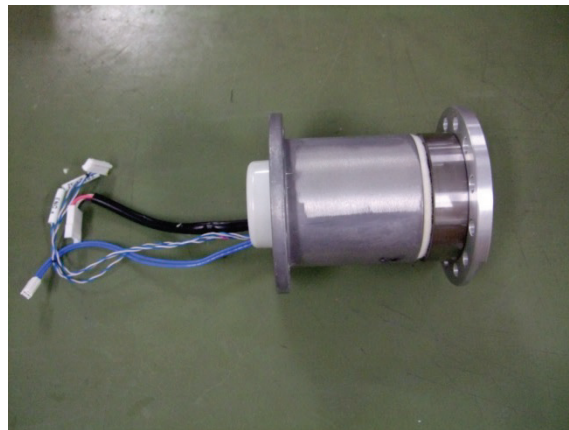

Joint #4 Actuator Unit

### Removal: Joint #4 Actuator Unit

#### Removal

- (1) Turn ON the Controller.
- (2) Release the Joint #3 brake.

**EPSON** Command  
**RC+** > brake off, 3

- (3) Tilt the angle of the Arm #3 about 90 degrees from the origin posture.
- (4) Turn OFF the Controller.

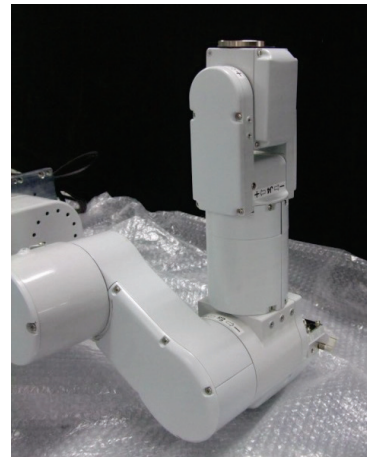

- (5) Remove the following covers.

- Arm #4 left side cover
- Arm #4 right side cover
- Arm #3 side cover (2 covers)
- Arm #3 upper side cover (2 covers)

For details, refer to *Maintenance 3. Covers*.

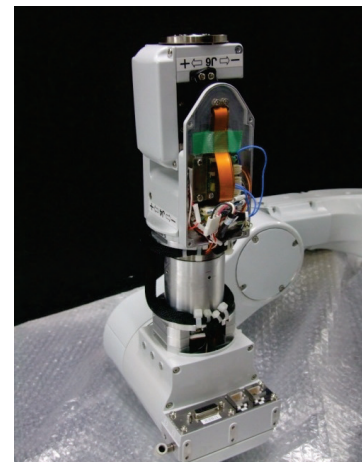

- (6) Remove the Arm #3 upper side covers.

#### NOTE



Be careful not to cut off the cables.

For details, refer to *Maintenance 3. Covers*.

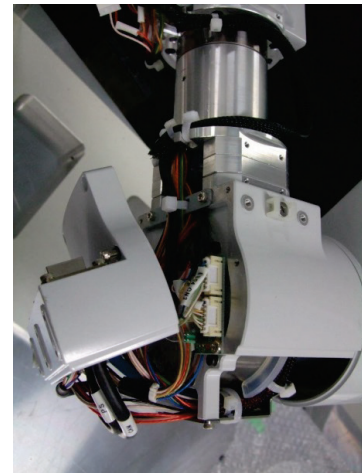

- (7) Before cutting off the wire ties, put a mark on the surface of the cables near the wire tie with a permanent marker.

Also, fix the braided tube with wire ties to prevent disconnection.

Cut off the wire ties bundling the cables.

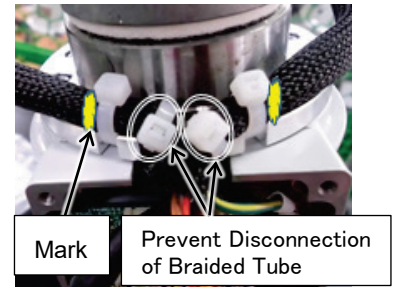

When cutting of the wire ties, be careful not to damage the cables.

Do not cut off of the wire ties other than the ones bundling the cables.

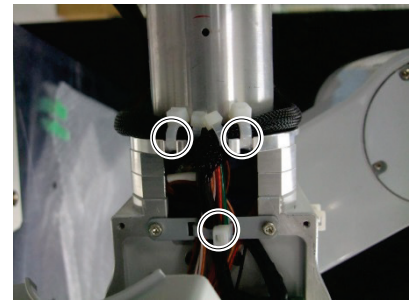

- (8) Remove the cable fixing plate.

Hexagon socket head cap bolt: 2-M3×6

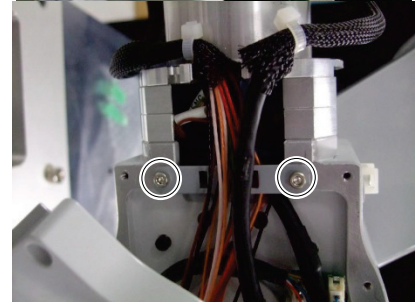

- (9) Remove the following connectors connected to the Joint #4 actuator unit.

Connector: EB0x\_CN2, PW4, BR4  
(Push the latch and pull to remove.)



Be careful that the jumper pins on the board do not come off.

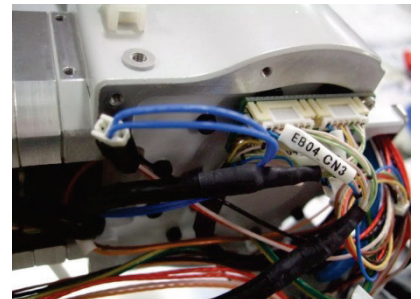

- (10) Loosen the FPC Power Connector mounting screws.

Remove the connector and ground wire from the Arm #4.

Connector:  
PW5, J6P-01, BR5, FL\_CN2, EB05\_CN1

Ground wire (green/yellow) :  
Cross recessed screw: M4×6

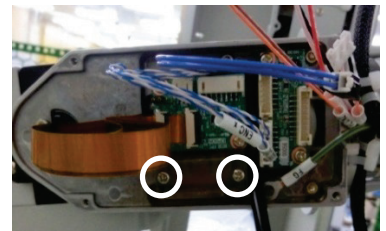

Be careful that the jumper pins on the board do not come off.

(11) Remove the Arm #4.

Hexagon socket head cap bolt:  
10-M3×8 (with plain washer)

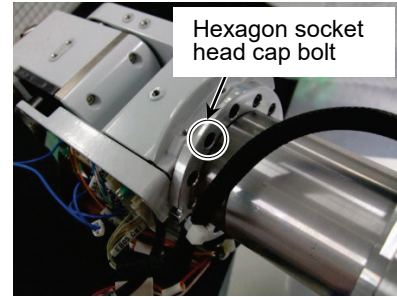

(12) Remove the Joint #4 actuator unit from the Arm #3.

Hexagon socket head cap bolt:  
10-M3×10 (with plain washer)

There is a positioning pin (2- $\phi$ 3×8) between the Arm #3 and the Joint #4 actuator unit.  
Be careful not to lose it.

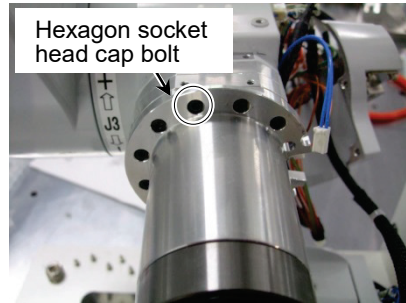

## Installation: Joint #4 Actuator Unit

## Installation

- (1) Insert the positioning pin to the Arm #3.  
Install the Joint #4 actuator unit to the Arm #3.

Positioning pin: 2- $\phi$ 3 $\times$ 8

Hexagon socket head cap bolt:  
10-M3 $\times$ 10 (with plain washer)

Tightening torque: 2.4  $\pm$  0.1 N·m

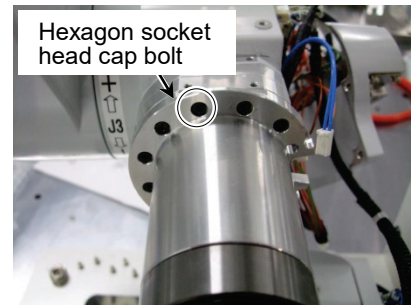

- (2) Check if there is an O-ring on the Joint #4 actuator unit.

O-ring: Inner diameter  $\phi$  51.0 mm  
Wire diameter  $\phi$  1.5 mm

## NOTE



Apply a thin coat of grease (SK-2) to the O-ring.

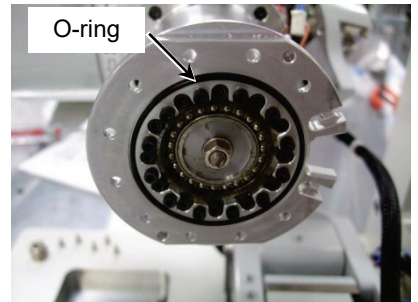

- (3) Install the Arm #4.

Align the positions of the cables coming from the Arm #4 and the groove on the flange.

Hexagon socket head cap bolt:  
10-M3 $\times$ 8 (with plain washer)

Tightening torque: 2.4  $\pm$  0.1 N·m

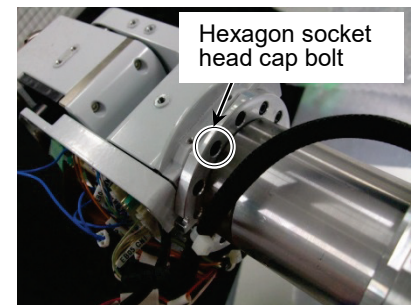

## NOTE



Apply the grease to the cable contacting part on the actuator unit.

For details, refer to *Maintenance 4.1. Replacing the Cable Unit*.

- (4) Connect the following connectors.

Connector: EB0x\_CN2, PW4, BR4

## NOTE



Be careful that the jumper pins on the board do not come off.



- (5) Temporarily fix the cables to the cable fixing plate with the wire ties, and then fix the plate to the Arm #3.

Hexagon socket head cap bolt: 2-M3 $\times$ 6  
Tightening torque: 2.0  $\pm$  0.1 N·m

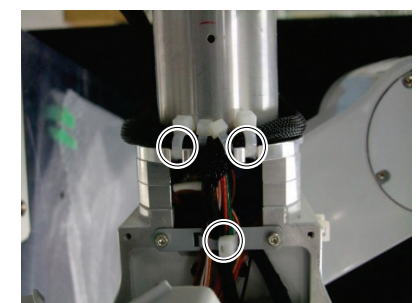

- (6) Fix the cables with the wire ties according to the marks put in the removal step (7).

Wire tie (AB200) : 3 ties

Wire tie (AB150) : 2 ties

Tightening strength:  $85 \pm 5\text{N}$

Position:

Joint #4 actuator unit:

Arm #3 side flange: 2 ties (AB200)

Arm #4 side flange: 2 ties (AB150)

Cable fixing plate: 1 tie (AB200)

For details, refer to *Maintenance 4.1. Replacing the Cable Unit: Installation (42)*.

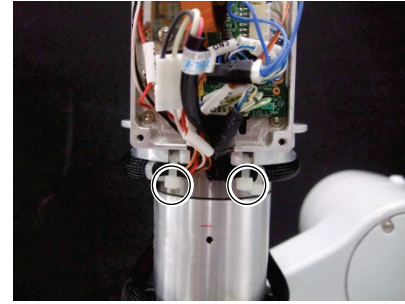

- (7) Mount connector and ground wire on the Arm#4.

Connectors: PW5, J6P-01, BR5, FL\_CN2, EB05\_CN1

Ground wire (green/yellow): Cross recessed screw: 2-M3×6

- (8) Install the following covers in that order.

Arm #3 outside cover

Arm #3 upper cover

Arm #3 upper side cover (2 covers)

Arm #3 side cover (2 covers)

Arm #4 right side cover

Arm #4 left side cover

For details, refer to *Maintenance 3. Covers*.

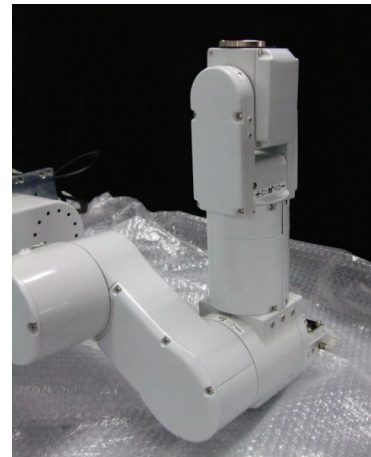



- (9) Calibrate the Joint #4.

For details, refer to *Maintenance 8. Calibration*.



## 5.5 Joint #5

 <b>CAUTION</b>	<ul style="list-style-type: none"> <li>■ This procedure has possibility of hands and fingers being caught and/or damage or malfunction to the Manipulator. Be very careful when performing maintenance.</li> </ul>
---	--

NOTE  The Joint #5 is not equipped with the actuator unit. Replace the following parts for each. Motor unit, reduction gear unit, timing belt

### 5.5.1 Replacing the Motor Unit

	Name		Quantity	Note
Maintenance Parts	Joint #5 motor unit		1	1696700
	Belt tensile jig*		1	1696718
	Wire tie (AB150)		-	1675754 1 bag (100 ties: white)
Tools	Hexagonal wrench	width across flats: 1.5 mm	1	For M3 hexagon socket set screws
		width across flats: 2.5 mm	1	For M3 hexagon socket head cap bolts
	Cross-point screwdriver (#2)		1	For cross recessed head screws
	Torque wrench		1	For tightening torque control
	Nippers		1	For cutting the wire ties
	Belt tension meter		1	Refer: Unitta U-505
	Cable tie gun		1	Refer: HellermannTyton MK8
	Cable tie gun tester		1	Refer: HellermannTyton DGT500-MK8

\* The belt tensile jig is an assembly jig. Use this jig when adjusting belt tension.

The brake is mounted on each joint to prevent the arm from lowering due to its own weight while the Controller power is OFF or the motor is OFF status. The brake does not work during replacement. Be careful when performing maintenance work.

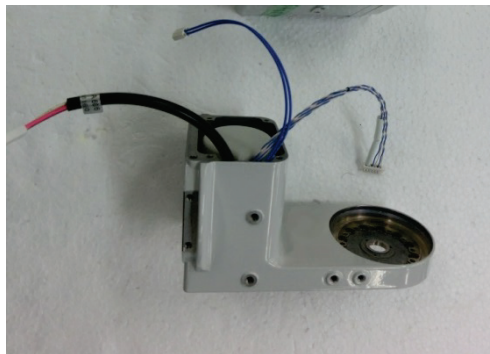

Joint #5 Motor Unit

Removal: Joint #5 motor unit

Removal

- (1) Turn ON the Controller.
- (2) Release the Joint #2 and #3 brakes.
- (3) Tilt the angle between the Arms #2 and #3 about 45 degrees.
- (4) Turn OFF the Controller.
- (5) Remove the following covers.

```

EPSON Command
RC+ > brake off, 2
    > brake off, 3
    
```

- Arm #4 right side cover
- Arm #4 left side cover
- Arm #3 side cover

For details, refer to *Maintenance 3. Covers.*

- (6) Remove the Joint #5 timing belt.

For details, refer to *Maintenance 5.5.3 Replacing the Timing Belt*

- (7) Remove the boards on the Arm #4.

- Board: Encoder board 4
- FPC board 1

For details, refer to *Maintenance 7. Boards.*

- (8) Before cutting off the wire ties, put a mark on the both side of wire tie fixed part with a permanent marker. Also, fix the braided tube with wire ties to prevent disconnection.

Cut off the wire ties from the flange on the Joint #4 actuator unit.

When cutting off the wire ties, be careful not to damage the cables.

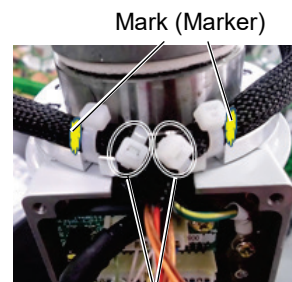
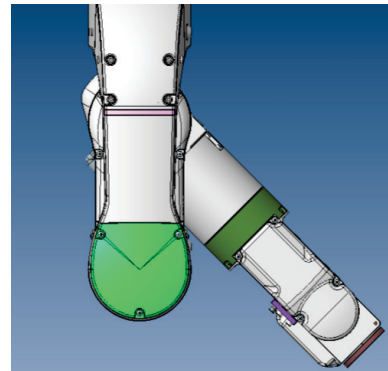

Wire Tie for Prevent Disconnection of Braided Tube

- (9) Remove the wire ties on the Joint #4 actuator unit. (2 ties on the Arm #4 side flange)

When cutting off the wire ties, be careful not to damage the cables.



Do not cut off of the wire ties other than the ones bundling the cables.

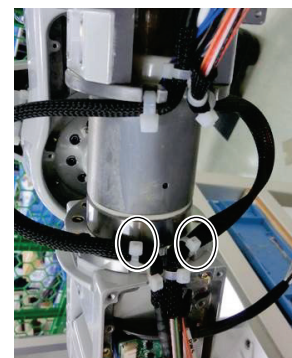

- (10) Separate the Joint #4 actuator unit from the Arm #4.

Hexagon socket head cap bolt:  
10-M3×8 (with plain washer)



- (11) Remove the FPC unit from the Joint #6 actuator unit.

For details, refer to *Maintenance 4.3. Replacing the FPC Unit.*

- (12) Remove the timing belt from the Joint #5, #6 actuator unit.

For details, refer to *Maintenance 5.5.3 Replacing the Timing Belt: Removal*

- (13) Remove the two pulleys from the Joint #5, #6 actuator unit.

Hexagon socket set screw: 4-M3×8

- (14) Remove the Joint #5 reduction gear unit.

For details, refer to *Maintenance 5.5.2 Replacing the Reduction Gear Unit.*

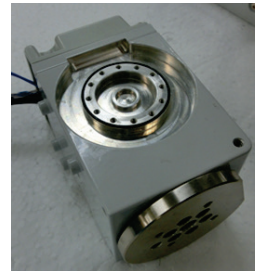

Installation: Joint #5 motor unit

- Installation (1) Install the Joint #5 reduction gear unit to the Joint #6 actuator unit.

For details, refer to *Maintenance 5.5.2 Replacing the Reduction Gear Unit, installation steps.*

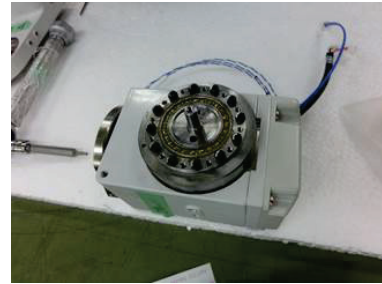

- (2) Install the Joint #5 reduction gear unit to the Joint #5 motor unit.

For details, refer to *Maintenance 5.5.2 Replacing the Reduction Gear Unit, installation steps.*

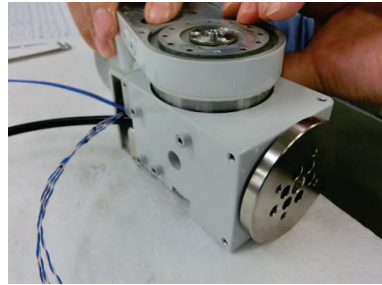

- (3) Install the two pulleys to the Joint #5, #6 actuator unit.

Hexagon socket set screw: 4-M3×8

NOTE  Be careful of the installation direction of the pulleys.

Install the non-flanged pulley to the shaft on the Joint #5 reduction gear unit side.



Install both pulleys to the shaft with set screws while pressing the protruding parts on the surface to the bearing. Rotate the pulleys so that the set screws touch the D-cut surface on the shaft.

Fix the pulleys while aligning the end face of the shaft and that of the pulley.

- (4) Install the FPC unit to the Joint #6 actuator unit.

For details, refer to *Maintenance 4.3. Replacing the FPC Unit.*

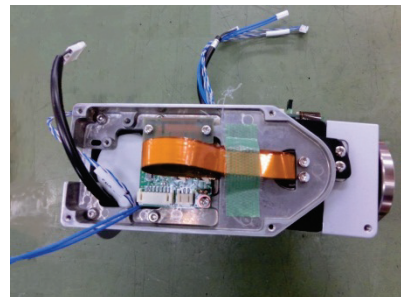

- (5) Install the timing belt to the Joint #5, #6 actuator unit.

For details, refer to *Maintenance 5.5.3 Replacing the Timing Belt*

- (6) Install the Joint #5 motor to the Joint #4 actuator unit.

Hexagon socket head cap bolt:  
10-M3×8 (with plain washer)

Tightening torque:  $2.4 \pm 0.1$  N·m



- (7) Fix the cables to the flange of the Joint #4 actuator unit with the wire ties according to the marks put in the removal step (8).

Wire tie (AB150): 2 ties

Tightening strength:  $85 \text{ N} \pm 5 \text{ N}$

Cut off the wire ties attached for preventing disconnection of braided tube.



- (8) Install the board unit to the Arm #4.

Board: Encoder board 4  
FPC board 1

For details, refer to *Maintenance 7. Boards*.

- (9) Install the following covers.

Arm #4 right side cover

Arm #4 left side cover

Arm #3 side cover

For details, refer to *Maintenance 3. Covers*.

- (10) Perform the calibration.

For details, refer to *Maintenance 8. Calibration*.

## 5.5.2 Replacing the Reduction Gear Unit

	Name	Quantity	Note
Maintenance Parts	Joint #5 reduction gear unit	1	1696702
	Belt tensile jig*	1	1696718
	Wire tie (AB150)	-	1675754 1 bag (100 ties: white)
Tools	Hexagonal wrench	width across flats: 1.5 mm	1 For M3 hexagon socket set screws
		width across flats: 2.0 mm	1 For M2.5 hexagon socket head cap bolts
		width across flats: 2.5 mm	1 For M3 hexagon socket head cap bolts
	Cross-point screwdriver (#2)	1	For cross recessed head screws
	Torque wrench	1	For tightening torque control
	Belt tension meter	1	Refer: Unitta U-505
	Nippers	1	For cutting the wire ties
	Cable tie gun	1	Refer: HellermannTyton MK8
Cable tie gun tester	1	Refer: HellermannTyton DGT500-MK8	

The brake is mounted on each joint to prevent the arm from lowering due to its own weight while the Controller power is OFF or the motor is OFF status. The brake does not work during replacement. Be careful when performing maintenance work.

## Removal: Joint #5 reduction gear unit

- Removal:
- (1) Turn ON the Controller.
  - (2) Release the Joint #2 and #3 brakes.
  - (3) Tilt the angle between the Arms #2 and #3 about 45 degrees.
  - (4) Turn OFF the Controller.
  - (5) Remove the following covers.

EPSON RC+ Command  
 > brake off, 2  
 > brake off, 3

Arm #4 right side cover  
 Arm #4 left side cover  
 Arm #3 side cover

For details, refer to *Maintenance 3. Covers*.

- (6) Remove the timing belt.  
 For details, refer to *Maintenance 5.5.3 Replacing the Timing Belt*.
- (7) Remove the boards on the Arm #4.  
 Board: Encoder board 4  
 FPC board 1

For details, refer to *Maintenance 7. Boards*.

- (8) Cut off the wire ties on the Joint #4 actuator unit.  
 (Flange of the Arm #4 side)

For details, refer to *Maintenance 5.5.1 Replacing the Motor Unit: Removal (8)*.

When cutting off the wire ties, be careful not to damage the cables.

- (9) Separate the Joint #4 actuator unit from the Arm #5.

Hexagon socket set screw: 10-M3×8 (with plain washer)

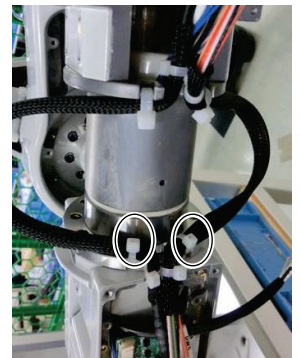
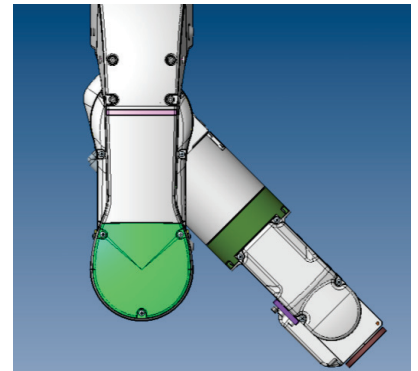

- (10) Remove the FPC unit.

For details, refer to *Maintenance 4.3. Replacing the FPC Unit.*

- (11) Remove the timing belt.

For details, refer to *Maintenance 5.5.3 Replacing the Timing Belt.*

- (12) Remove the non-flanged pulley shown in the photo.

Hexagon socket set screw: 2-M3×8

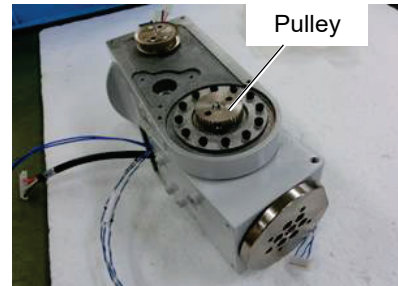

- (13) Remove the bolts fixing the Joint #5, #6 actuator unit.

Hexagon socket head cap bolt:  
12-M2.5×8 (with plain washer)

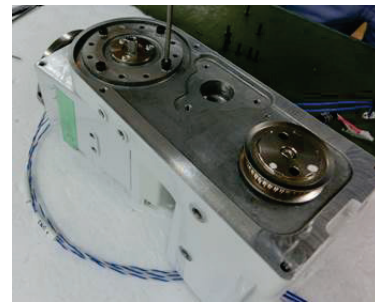

- (14) Pull the Joint #6 actuator unit by hand, and pull out the shaft from the bearing.

**NOTE**  The shaft and the wave generator of the reduction gear unit are integrated. The wave generator may come off.

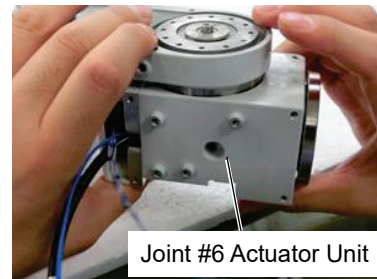

The O-ring (inner diameter  $\varnothing 24$  mm, wire diameter  $\varnothing 1.5$  mm) will come off when the Joint #6 actuator unit is removed.

- (15) Remove the bearing holder.

Cross recessed flat head machine screw:  
3-M2×5



- (16) Remove the wave generator from the reduction gear unit.

**NOTE**  Hold the shaft by hand to pull.





(17) Remove the circular spline.

Hexagon socket head cap bolt: 12-M2.5×6



(18) Remove the flexspline.

Hexagon socket head cap bolt: 9-M3×8



(19) Remove the cross roller bearing.

Hexagon socket head cap bolt: 12-M2.5×6

 NOTE The following parts will also be removed when the cross roller bearing is removed.

Wave washer

Bearing (695)

O-ring (inner diameter  $\varnothing 36$  mm, wire diameter  $\varnothing 1$  mm)



Installation: Joint #5 reduction gear unit

- Installation (1) Assemble the bearing to the cross roller bearing.  
After assembling the bearing, set the wave washer on it.

Bearing: 695

Wave washer: Inner diameter  $\varnothing$  10 mm  
Outside diameter  $\varnothing$  20 mm



- (2) Install the O-ring to the Joint #6 actuator unit.  
Install the cross roller bearing.

O-ring: Inner diameter  $\varnothing$  36 mm  
Wire diameter  $\varnothing$  1 mm

Apply a thin coat of grease (SK-2) to the O-ring.



NOTE



Prevent the following parts from being detached.

- Wave washer
- Bearing (695)
- Cross roller

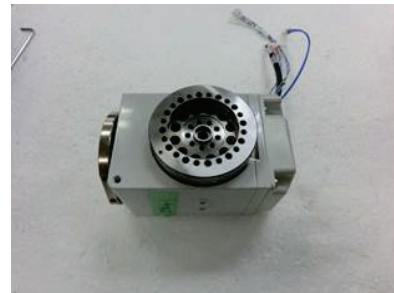

- (3) Install the flexspline to the cross roller bearing.

Hexagon socket head cap bolt: 9-M3 $\times$ 8

Tightening torque:  $2.4 \pm 0.1$  N·m

- (4) Apply grease to the flexspline.

Grease: SK-2

Grease amount: 2.9 g



- (5) Install the circular spline to the Joint #6 actuator unit.

Hexagon socket head cap bolt: 12-M2.5 $\times$ 6

Tightening torque:  $1.4 \pm 0.1$  N·m

- (6) Apply grease to the circular spline.

Grease: SK-2

Grease amount: 0.1 g



- (7) Install the wave generator to the reduction gear unit.



NOTE  
Install the pulley to the D-cut side of the shaft.  
Install the wave generator so that the screw hole side can be seen.

- (8) Apply grease to the wave generator.

Grease: SK-2

Grease amount: 0.5 g

- (9) Install the O-ring to the Arm #4.

O-ring: Inner diameter  $\varnothing$  24mm

Wire diameter  $\varnothing$  1.5mm

Apply a thin coat of grease (SK-2) to the O-ring.

- (10) Assemble the bearing to the shaft, and then fix the bearing holder.

Bearing: 2F-WBC6-12

Cross recessed flat head machine screw:

3-M2 $\times$ 5

Tightening torque:  $0.3 \pm 0.05$  N·m

- (11) Fix the Joint #5 reduction gear unit to the Arm #4.

Hexagon socket set screw:

12-M2.5 $\times$ 8 (with plain washer)

Tightening torque:  $1.4 \pm 0.1$  N·m

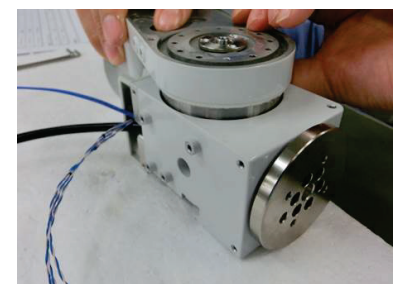
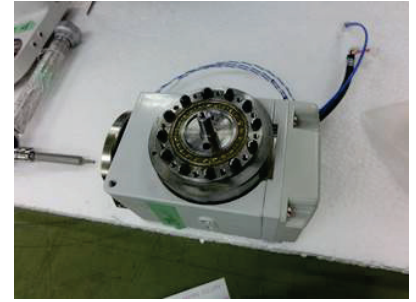

- (12) Install the non-flanged pulley to the shaft of the Joint #5 reduction gear unit.

Hexagon socket set screw: 2-M3×8

Tightening torque:  $0.9 \pm 0.1 \text{ N}\cdot\text{m}$

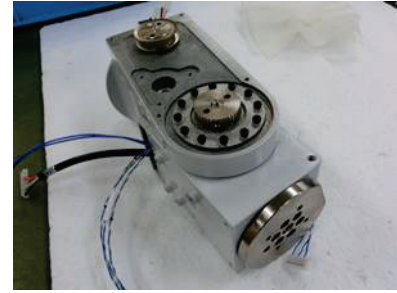

**NOTE** Fix the set screws while pressing the protruding parts on the pulley to the bearing.  
 Rotate the pulleys so that the set screws touch the D-cut surface on the shaft.

Fix the pulley where the end face of the shaft and that of the pulley match.

- (13) Install the FPC unit.

For details, refer to *Maintenance 4.3. Replacing the FPC Unit.*

- (14) Install the Joint #5 motor to the Joint #4 actuator unit.

Hexagon socket set screw: 10-M3×8 (with washer)

Tightening torque:  $2.4 \pm 0.1 \text{ N}\cdot\text{m}$



- (15) Install the following board units to the Arm #4.

Board: Encoder board 4, FPC board 1

For details, refer to *Maintenance 7. Boards.*

- (16) Install the timing belt to the Arm #4.

For details, refer to *Maintenance 5.5.3 Replacing the Timing Belt.*

- (17) Fix the cables to the flange of the Joint #4 actuator unit with the wire ties.

For details, refer to *Maintenance 5.5.1 Replacing the Motor Unit: Removal (7).*

Wire tie (AB150) : 2 ties

Tightening strength:  $85 \text{ N} \pm 5 \text{ N}$



- (18) Install the following covers.

Arm #4 right side cover

Arm #4 left side cover

Arm #3 side cover

For details, refer to *Maintenance 3. Covers.*

(19) Perform the calibration.

For details, refer to *Maintenance 8. Calibration*.

### 5.5.3 Replacing the Timing Belt

	Name	Quantity	Note	
Maintenance Parts	Joint #5 timing belt (260 mm)	1	1698992	
	Belt tensile jig*	1	1696718	
Tools	Hexagonal wrench	width across flats: 2.5 mm	1	For M3 hexagon socket head cap bolts
		width across flats: 3 mm	1	For M4 hexagon socket head cap bolts
	Cross-point screwdriver (#2)	1	For cross recessed head screws	
	Torque wrench	1	For tightening torque control	
	Belt tension meter	1	Refer: Unitta U-505	

\* The belt tensile jig is an assembly jig. Use this jig when adjusting belt tension.

The brake is mounted on each joint to prevent the arm from lowering due to its own weight while the Controller power is OFF or the motor is OFF status. The brake does not work during replacement. Be careful when performing maintenance work.

#### Removal: Joint #5 timing belt

- Removal:
- (1) Turn ON the Controller.
  - (2) Release the Joint #2 and #3 brakes.
  - (3) Tilt the angle between the Arms #2 and #3 about 45 degrees.
  - (4) Turn OFF the Controller.
  - (5) Remove the Arm #4 side cover.
  - (6) Remove the idler.

**EPSON RC+** Command  
 > brake off, 2  
 > brake off, 3

For details, refer to *Maintenance 3. Covers*.

Hexagon socket head cap bolt:  
 3-M3×8 (with plain washer)

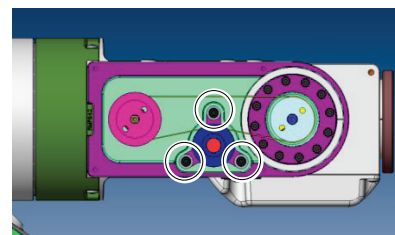
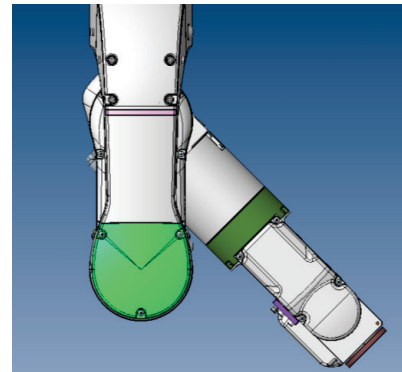

- (7) Remove the Joint #5 timing belt.

## Installation: Joint #5 Timing Belt

Installation (1) Set the Joint #5 timing belt around the pulleys.  
Check that the teeth of the timing belt engage with these of the pulleys.

(2) Temporarily fix the idler.

Hexagon socket head cap bolt:  
3-M3×8 (with plain washer)

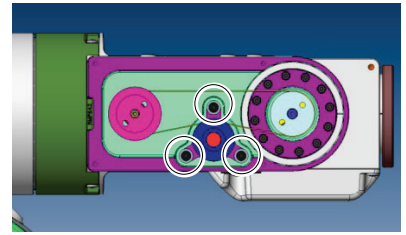

(3) Install the belt tensile jig.

Hexagon socket head cap bolt: 2-M4×12

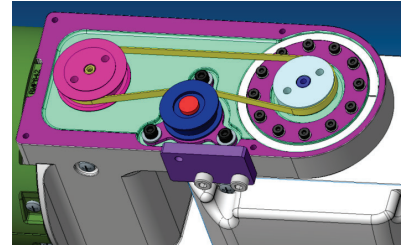

(4) Install the bolt for pushing the idler to the belt tensile jig.

Hexagon socket head cap bolt:  
M4×15 (with polyacetal)

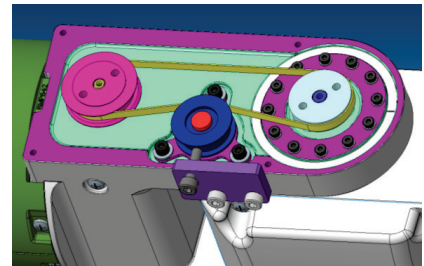

NOTE  Push the idler gradually using a rubber sheet as an intermediary so as not to damage the idler.

(5) Use the belt tension meter to apply appropriate tension to the Joint #5 timing belt, and then fix the idler.

Joint #5 timing belt tension:  $9.5 \pm 2\text{N}$

Belt tension meter setting value

Weight:  $1.3 \text{ g/mm width} \times \text{m span}$ , Width: 4 mm, Span: 89 mm

Hexagon socket head cap bolt: 3-M3×8 (with plain washer)

Tightening torque:  $2.4 \pm 0.1 \text{ N}\cdot\text{m}$

NOTE 

Regarding belt tension:

- Jumping (position gap) may occur if the value is below the lower limit.
- Vibration (abnormal noise) or reduction of life of the parts may occur if the value exceeds the upper limit.
- A new belt has low tension. Check the tension of the belt after 48 hours of the operation.

(6) Remove the belt tensile jig.

Hexagon socket head cap bolt: 2-M4×12

(7) Install the Arm #4 right side cover.

For details, refer to *Maintenance 3. Covers*.

## 5.6 Replacing the Joint #5, #6 Actuator Unit



CAUTION

- This procedure has possibility of hands and fingers being caught and/or damage or malfunction to the Manipulator. Be very careful when performing maintenance.

	Name	Quantity	Maintenance parts code, remarks
Maintenance Parts	#5, #6 actuator unit	1	1696703
	Wire tie (AB150)	-	1675754 1 bag (100 ties: white)
Tools	Hexagonal wrench (width across flats: 2.5 mm)	1	For M3 hexagon socket head cap bolts
	Cross-point screwdriver (#2)	1	For cross recessed head screws
	Torque wrench	1	For tightening torque control
	Nippers	1	For cutting the wire ties
	Cable tie gun	1	Refer: HellermannTyton MK8
	Cable tie gun tester	1	Refer: HellermannTyton DGT500-MK8

The brake is mounted on each joint to prevent the arm from lowering due to its own weight while the Controller power is OFF or the motor is OFF status. The brake does not work during replacement. Be careful when performing maintenance work.



## Removal: Joint #5, #6 actuator unit

Removal:

- (1) Turn ON the Controller.
- (2) Release the Joint #2 and #3 brakes.
 

EPSON  
RC+

 Command  
 > brake off, 2  
 > brake off, 3
- (3) Tilt the angle between the Arms #2 and #3 about 45 degrees.
- (4) Turn OFF the Controller.
- (5) Remove the following covers.
  - Arm #4 right side cover
  - Arm #4 left side cover
  - Arm #3 side cover

For details, refer to *Maintenance 3. Covers*.

- (6) Remove the following connectors.

Connector:

PW5, J6P\_01, BR5, EB05\_CN1,  
 FL\_CN2, FL01\_CN1, EB05\_CN3,  
 EB0x\_CN2

**NOTE**  Be careful that the jumper pins on the board do not come off.

- (7) Remove the wire ties (2 ties) from the flange of the Joint #4 actuator unit.

For details, refer to *Maintenance 5.5.1 Replacing the Motor Unit: Removal (8)*.

- (8) Separate the Joint #4 actuator unit from the Arm #5.

Hexagon socket head cap bolt:  
 10-M3×8 (with plain washer)

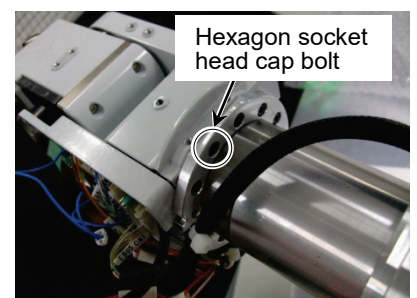
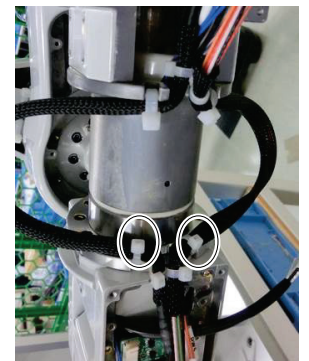
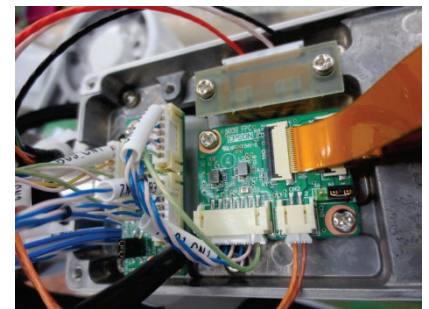
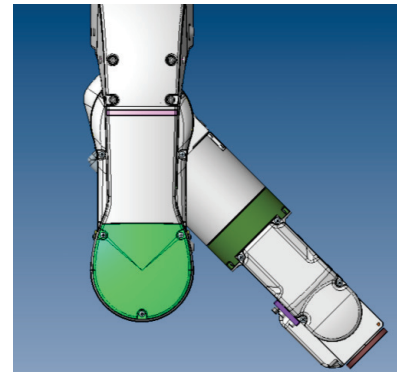

Installation: Joint #5, #6 actuator unit

Installation

- (1) Check if there is the O-ring on the Joint #4 actuator unit.

O-ring: Inner diameter  $\varnothing$  51.0 mm  
Wire diameter  $\varnothing$  1.5 mm

Apply a thin coat of grease (SK-2) to the O-ring.

- (2) Install the Joint #5, #6 actuator unit to the Joint #4 actuator unit.

Hexagon socket head cap bolt:  
10-M3 $\times$ 8 (with plain washer)

Tightening torque:  $2.4 \pm 0.1$  N·m

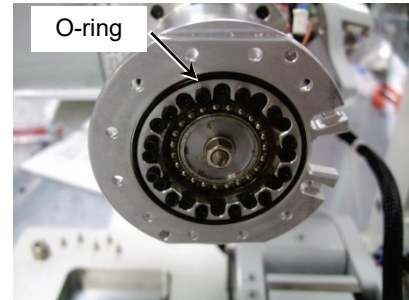
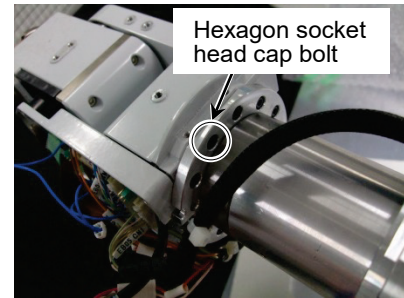

- (3) Fix the cables to the flange of the Joint #4 actuator unit with the wire ties (2 ties).

Wire tie (AB200) 2 tie

Wire tie tightening strength:  $85 \pm 5$  N

For details, refer to *Maintenance 5.5.1 Replacing the Motor Unit: Removal (7)*.



- (4) Connect the following connectors.

Connector:  
PW5, J6P\_01, BR5, EB05\_CN1, FL\_CN2,  
FL01\_CN1, EB05\_CN3, EB0x\_CN2

**NOTE** Be careful that the jumper pins on the board do not come off.

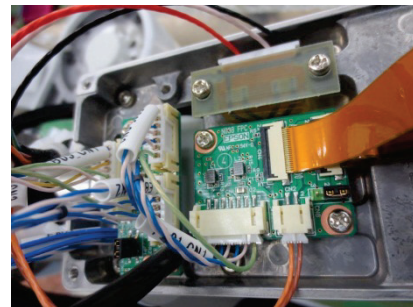

- (5) Install the following covers.

Arm #4 left side cover

Arm #4 right side cover

Arm #3 side cover

For details, refer to *Maintenance 3. Covers*.

- (6) Perform the calibration.

For details, refer to *Maintenance 8. Calibration*.

## 5.7 Replacing the Joint #6 Actuator Unit

 <b>CAUTION</b>	<p>■ This procedure has possibility of hands and fingers being caught and/or damage or malfunction to the Manipulator. Be very careful when performing maintenance.</p>
---	---

	Name	Quantity	Note	
Maintenance Parts	Joint #6 actuator unit	1	1696701	
	Belt tensile jig*	1	1696718	
Tools	Hexagonal wrench	width across flats: 1.5 mm	1	For M3 hexagon socket set screws
		width across flats: 2.0 mm	1	For M2.5 hexagon socket set screws
		width across flats: 2.5 mm	1	For M3 hexagon socket head cap bolts
	Cross-point screwdriver (#2)	1	For cross recessed head screws	
	Torque wrench	1	For tightening torque control	
Belt tension meter	1	Refer: Unitta U-505		

\* The belt tensile jig is an assembly jig. Use this jig when adjusting belt tension.

The brake is mounted on each joint to prevent the arm from lowering due to its own weight while the

Controller power is OFF or the motor is OFF status. The brake does not work during replacement. Be careful when performing maintenance work.

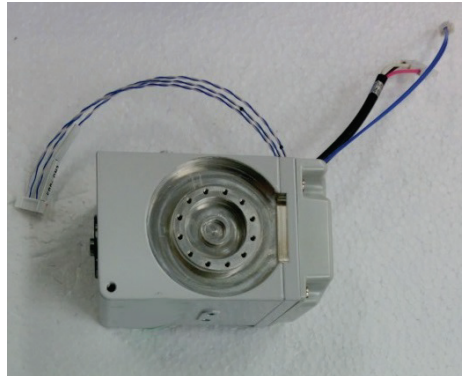

Joint #6 Actuator Unit

### Removal: Joint #6 actuator unit

#### Removal

- (1) Remove the Joint #5 reduction gear unit.

For details, refer to *Maintenance 5.5.2 Replacing the Reduction Gear Unit*.

- (2) Remove the flange.

Hexagon socket head cap bolt: 6-M3×5



Installation: Joint #6 Actuator Unit

Installation

- (1) Install the flange to the Joint #6 actuator unit.

Hexagon socket head cap bolt: 6-M3×5

Tightening torque:  $2.4 \pm 0.1$  N·m

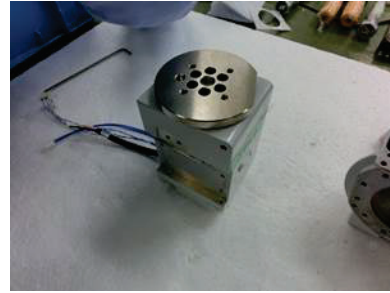

- (2) Install the Joint #5 reduction gear unit.

For details, refer to *Maintenance 5.5.2 Replacing the Reduction Gear Unit.*

- (3) Install the non-flanged pulley to the shaft of the Joint #5 reduction gear unit.

Hexagon socket set screw: 2-M3×8

Tightening torque:  $0.9 \pm 0.1$  N·m



**NOTE**  Fix the set screws while pressing the protruding parts on the pulley to the bearing. Rotate the pulleys so that the set screws touch the D-cut surface on the shaft.

Fix the pulley while aligning the end face of the shaft and that of the pulley.

- (4) Install the FPC unit.

For details, refer to *Maintenance 4.3. Replacing the FPC Unit.*

- (5) Install the board unit to the Arm #4.

Board: Encoder board 4

FPC board 1

For details, refer to *Maintenance 7. Boards.*

- (6) Install the timing belt to the Arm #4.

For details, refer to *Maintenance 5.5.3 Replacing the Timing Belt.*

- (7) Install the following covers.

Arm #4 right side cover

Arm #4 left side cover

For details, refer to *Maintenance 3. Covers.*

- (8) Perform the calibration.

For details, refer to *Maintenance 8. Calibration.*

## 6. Battery



WARNING

- Do not connect or disconnect the motor connectors while the power to the robot system is turned ON. Connecting or disconnecting the motor connectors with the power ON is extremely hazardous and may result in serious bodily injury as the Manipulator may move abnormally, and also may result in electric shock and/or malfunction of the robot system.
- To shut off power to the robot system, disconnect the power plug from the power source. Be sure to connect the AC power cable to a power receptacle. DO NOT connect it directly to a factory power source.
- Before performing any replacement procedure, turn OFF the Controller and related equipment, and then disconnect the power plug from the power source. Performing any replacement procedure with the power ON is extremely hazardous and may result in electric shock and/or malfunction of the robot system.



WARNING

- Take meticulous care when handling the lithium metal battery. Improper handling of the battery as mentioned below is extremely hazardous and may result in heat generation, leakage, explosion, or inflammation. It also may cause serious safety problems.
 

<Improper Handling>	
Attempting to charge	Deforming by pressure
Disassembling	Short-circuit (Polarity; Positive/Negative)
Connecting batteries improperly	Heating (85 °C or more)
Exposing to fire	Soldering the terminal of the lithium battery directly
Forcing discharge	
- When disposing the battery, consult with the professional disposal services or comply with the local regulation. Make sure that the battery terminal is insulated, even for a used battery. If the terminal contacts with the other metals, it may short and result in heat generation, leakage, explosion, or inflammation.

In case of the low battery (lithium metal battery) power, the error to warn the voltage reduction occurs at the Controller startup (the software startup). All position data will be lost and you will need to calibrate all joints.

The life span of the lithium metal battery varies depending on the energizing hours and installation environment of the Controller. It is about 3 years as a rough guide (when the Controller is connected to power for 8 hours a day). When the Controller is not connected to power, the battery consumption will significantly increase compared to when the Controller is energized. If warnings of voltage reduction occur, replace the lithium metal battery even if it has not reached the above product life.



NOTE

For the EPSON RC+ 7.0 Ver. 7.2.x or later (firmware Ver.7.2.x.x or later), the recommended replacement time for the battery can be checked in the [Maintenance] dialog box of the EPSON RC+ 7.0.

For details, refer to the following manual.

Robot Controller RC700 / RC700-A *Maintenance 6. Alarm*

## Maintenance 6. Battery

---

The battery may run out if it passes the recommended replacement time.

If no warnings of voltage reduction occur, the calibration for all joints is not necessary. You need to perform calibration if the position moves from the originals after replaced the battery.

Always use the lithium metal battery and battery board designated by us.

Be careful of the battery polarity to connect it correctly.

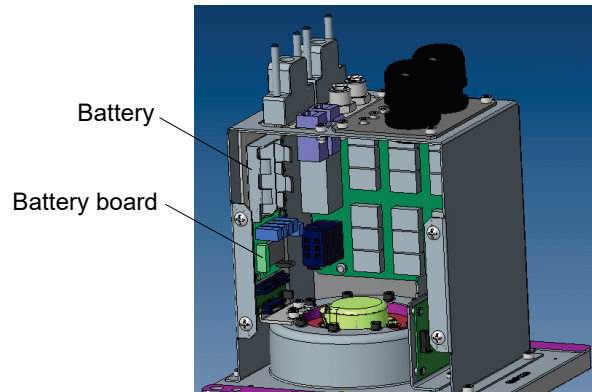

	Name	Quantity	Note
Maintenance Parts	Battery	1	2172925 (2 lithium metal batteries for replacement)
	Battery board	1	2173216
Tools	Cross-point screwdriver (#2)	1	For cross recessed head screws
	Hexagonal wrench (width across flats: 3 mm)	1	For M4 hexagon socket head cap bolts

## 6.1 Replacing the Battery Unit (Lithium Metal Battery)

- (1) Turn OFF the Controller.
- (2) Remove the base cover.

See the following section if the base cover cannot be removed due to a fixing pillar in the installation place.

For details, refer to *Maintenance 3. Covers*.

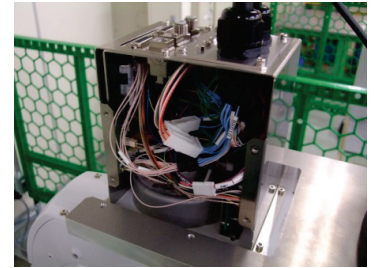

- (3) Remove the battery from the battery box.

**NOTE** Do not remove the connector.



If you removed all the batteries before connecting the new ones, the calibration data will be deleted and you will need to perform calibration.

Follow the steps below to remove the lithium metal batteries.

- (4) Connect the two new batteries to the connectors of the battery board which are not connected to anything.
- (5) Remove the old batteries.  
Hold the board by hand and pull the battery cable upward to remove the connector.

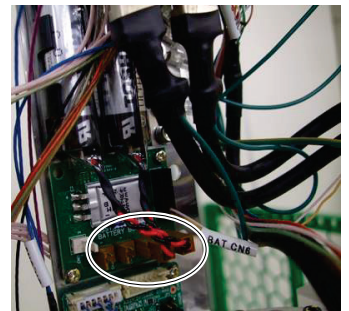

- (6) Install the battery to the battery box.
- (7) Install the base cover.

For details, refer to *Maintenance 3. Covers*.

- (8) Turn ON the Controller.
- (9) Check operation to see if the Manipulator's position and posture are out of position.  
Move the Manipulator to two or three points (poses) of the registered points.
- (10) If the Manipulator is out of position, calibrate all the joints and axes.

For details, refer to *Maintenance 8. Calibration*.

## 6.2 Replacing the Battery Board

After parts (actuator units, timing belts, etc.) or the battery board have been replaced, the Manipulator cannot perform positioning properly because a gap exists between the origin stored in each actuator unit and its corresponding origin stored in the Controller.

After replacing the parts, it is necessary to match these origins.

The process of aligning the two origins is called “Calibration”.

Refer to *Maintenance 8. Calibration* and follow the steps to perform calibration.

### Removal

(1) Turn OFF the Controller.

(2) Remove the base cover.

For details, refer to *Maintenance 3. Covers*.

(3) Remove the M/C cable.

For details, refer to *Maintenance 4.4 Replacing the M/C Cable*.

(4) Remove the brake release connector.

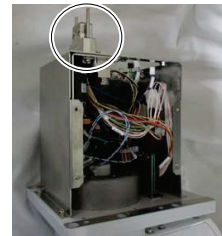

(5) Remove the base.

Hexagon socket head cap bolt:  
9-M4×8

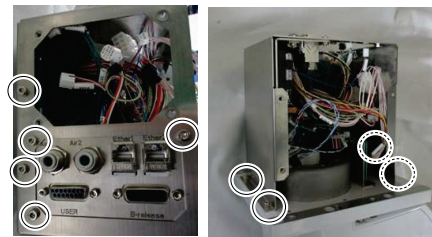

(6) Remove the batteries from the battery box.

(7) Remove the battery connectors.

### NOTE



Hold the board by hand and pull the battery cable upward to remove the connector.

(8) Remove the connectors from the battery board.

Connector: BAT\_CN3,  
BAT\_CN6

(9) Remove the battery board fixed to the fixing plate.

Cross recessed head screw: 2-M3×6

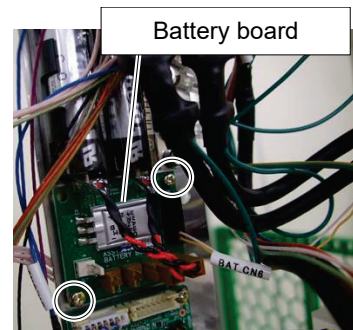



## Installation

- (1) Install the battery board to the fixing plate.

Cross recessed head screw: 2-M3×6

Tightening torque:  $0.45 \pm 0.05$  N·m

- (2) Connect the connectors to the battery board.

Connector: BAT\_CN3,  
BAT\_CN6

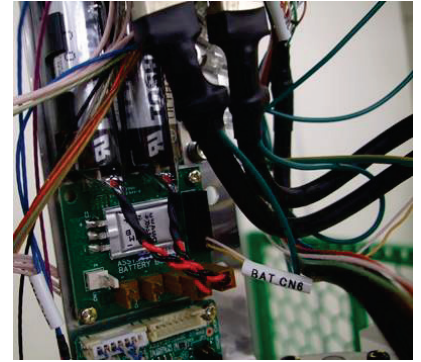

- (3) Connect the battery connectors.

- (4) Install the batteries to the battery box.

- (5) Install the base.

Hexagon socket head cap bolt: 9-M4×8

Tightening torque:  $4.0 \pm 0.2$  N·m

NOTE Be careful not to get the cables caught in the base.

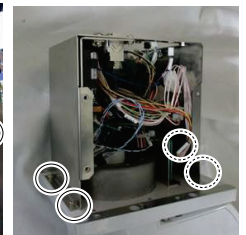
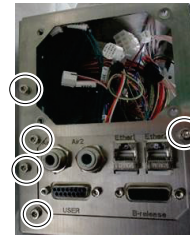

- (6) Install the brake release connector.

NOTE The user cable connector and the brake release connector have the same shape. Be careful not to connect the wrong connector.

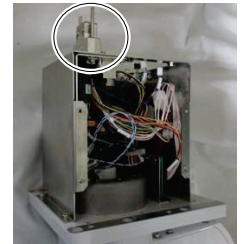

- (7) Install the M/C cable.

For details, refer to *Maintenance 4.4 Replacing the M/C Cable*.

- (8) Install the base cover.

For details, refer to *Maintenance 3. Covers*.

- (9) Perform calibration.

For details, refer to *Maintenance 8. Calibration*.

# 7. Boards



WARNING

- Do not connect or disconnect the motor connectors while the power to the robot system is turned ON. Connecting or disconnecting the motor connectors with the power ON is extremely hazardous and may result in serious bodily injury as the Manipulator may move abnormally, and also may result in electric shock and/or malfunction of the robot system.
- To shut off power to the robot system, disconnect the power plug from the power source. Be sure to connect the AC power cable to a power receptacle. DO NOT connect it directly to a factory power source.
- Before performing any replacement procedure, turn OFF the Controller and related equipment, and then disconnect the power plug from the power source. Performing any replacement procedure with the power ON is extremely hazardous and may result in electric shock and/or malfunction of the robot system.

Always use the boards designated by us.

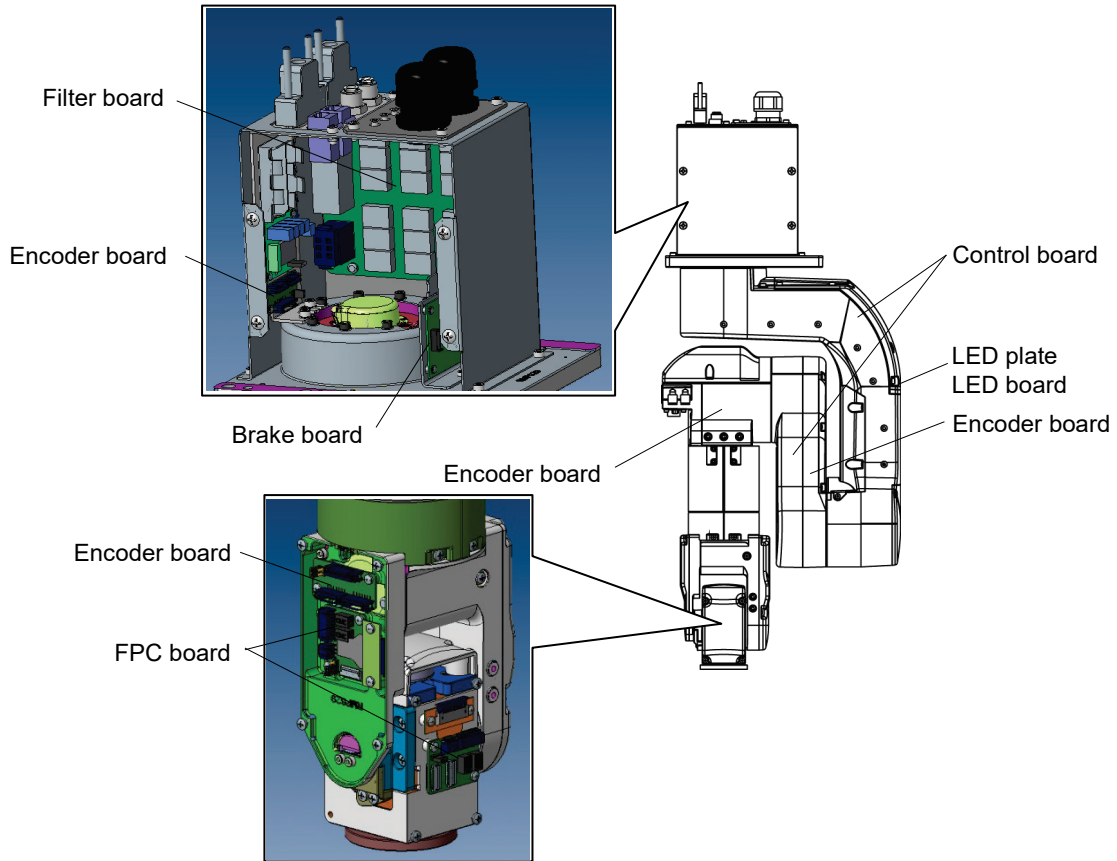

	Name	Quantity	Note
Maintenance Parts	Control board (1, 2)	1	2138032
	Encoder board (1, 2, 3, 4)	1	2179137
	Filter board	1	2178380
	Brake board	1	2178379
	FPC board (1, 2)	1	2179138
	LED board	1	2178376
Tools	Short head hexagonal wrench (width across flats: 3 mm)	1	For M4 hexagon socket head cap bolts
	Hexagonal wrench (width across flats: 3 mm)	1	For M4 hexagon socket head cap bolts
	Cross-point screwdriver (#2)	1	For cross recessed head screws

## 7.1 Replacing the Control Board 1

### Removal

- (1) Turn OFF the Controller.
- (2) Remove the Arm #1 outside cover.

For details, refer to *Maintenance 3. Covers*.

**NOTE** The cables are connected to the Arm #1 outside cover.



When removing the cover, be careful not to pull the cables forcibly.

- (3) Remove the connector connected to the LED board.

Connector: LED\_CN1

- (4) Remove the connector connected to the control board 1.

Connector: GS

- (5) Remove the control board fixed to the Arm #1.

Cross recessed head screw: 4-M3×6

**NOTE** Be careful not to drop the screws inside the



Manipulator while removing them.

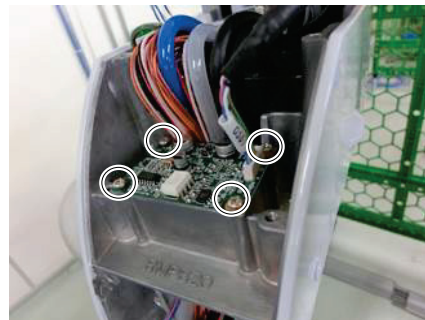

### Installation

- (1) Install the control board 1 to the Arm #1.

Cross recessed head screw: 4-M3×6

Tightening torque:  $0.45 \pm 0.05$  N·m

**NOTE**



Be careful not to drop the screws inside the Manipulator while installing them.

- (2) Connect the connector to the control board 1.

Connector: GS01

- (3) Connect the connector to the LED board 1.

Connector: LED\_CN1

- (4) Install the Arm #1 outside cover.

For details, refer to *Maintenance 3. Covers*.

**NOTE**



Be careful not to get the cables caught in the cover.

- (5) Turn ON the Controller.
- (6) Check operation to see if the Manipulator's position and posture are out of position. Move the Manipulator to two or three points (poses) of the registered points.
- (7) If the Manipulator is out of position, calibrate all the joints and axes.

For details, refer to *Maintenance 8. Calibration*.

## 7.2 Replacing the Control Board 2

### Removal

- (1) Remove the Arm #2 inside cover.

For details, refer to *Maintenance 3. Covers*.

- (2) Remove the control board 2.

Cross recessed head screw: 4-M3×6

NOTE The cables are connected to the control board 2.



When removing the board, be careful not to pull the cables forcibly.

- (3) Remove the connector connected to the control board 2.

Connector: GS02

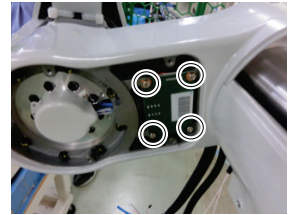

### Installation

- (1) Connect the connector to the control board 2.

Connector: GS02



- (2) Install the control board 2 to the Arm #2.

Cross recessed head screw: 4-M3×6

Tightening torque:  $0.45 \pm 0.05 \text{ N}\cdot\text{m}$

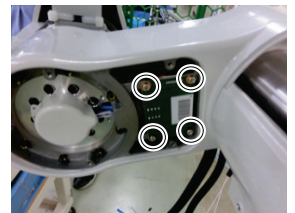

- (3) Install the Arm #2 inside cover.

For details, refer to *Maintenance 3. Covers*.

- (4) Turn ON the Controller.

- (5) Check operation to see if the Manipulator's position and posture are out of position. Move the Manipulator to two or three points (poses) of the registered points.

- (6) If the Manipulator is out of position, calibrate all the joints and axes.

For details, refer to *Maintenance 8. Calibration*.

### 7.3 Replacing the Encoder Board 1

Removal

- (1) Turn ON the Controller.
- (2) Remove the base cover.  
For details, refer to *Maintenance 3. Covers*.
- (3) Remove the M/C cable.  
For details, refer to *Maintenance 4.4 Replacing the M/C Cable*.
- (4) Remove the brake release connector.



- (5) Remove the base.  
Hexagon socket head cap bolt: 9-M4×8

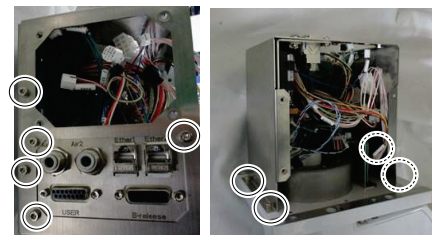

- (6) Remove the connectors connected to the encoder board 1.

Connector:  
EB01\_CN1, EB01\_CN3, EB0x\_CN2

NOTE Be careful that the jumper pins on the board do not come off.



- (7) Remove the encoder board 1.  
Cross recessed head screw: 4-M3×6

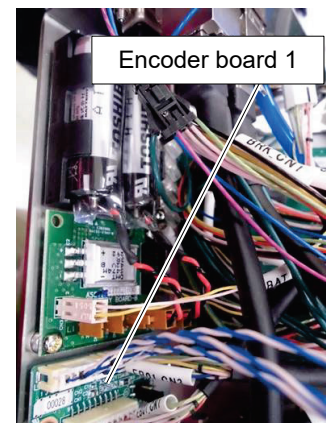

 <b>CAUTION</b>	<ul style="list-style-type: none"> <li>■ Improper jumper pin settings may result in occurrence of the errors such as below.            Example:            5042: Position error overflow in high power state.            Check the power cable connection, the robot, the driver and the motor.            When replacing the boards, be careful not to configure them incorrectly.</li> </ul>
---	--

## Installation

- (1) Check that the jumper pin of the encoder board 1 is at “3-4 short”.



- (2) Install the encoder board 1 to the user wire plate.

Cross recessed head screw: 4-M3×6

Tightening torque:  $0.45 \pm 0.05 \text{ N}\cdot\text{m}$

- (3) Connect the connectors to the encoder board 1.

Connector:

EB01\_CN1, EB01\_CN3, EB0x\_CN2

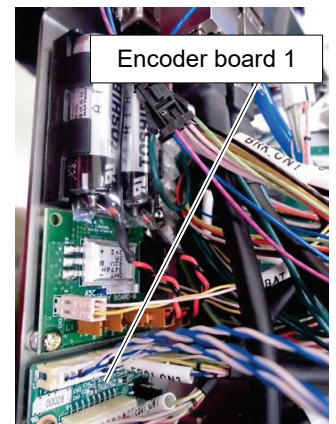

**NOTE**  Be careful that the jumper pins on the board do not come off.

- (4) Install the base.

Hexagon socket head cap bolt: 9-M4×8

Tightening torque:  $4.0 \pm 0.2 \text{ N}\cdot\text{m}$

**NOTE**  Be careful not to get the cables caught in the base.

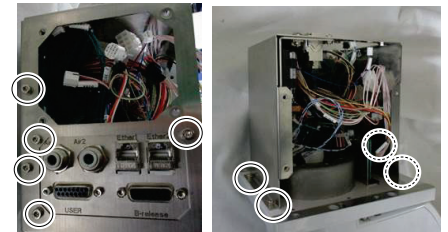

- (5) Install the brake release connector.

**NOTE**  The user cable connector and the brake release connector have the same shape. Be careful not to connect the wrong connector.

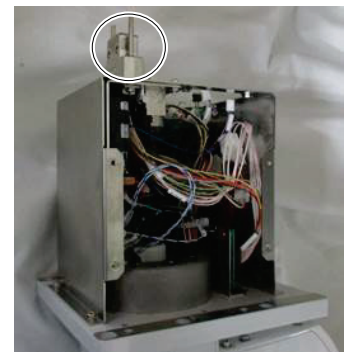

- (6) Install the M/C cable.

For details, refer to *Maintenance 4.4 Replacing the M/C Cable*.

- (7) Install the base cover.

For details, refer to *Maintenance 3. Covers.*

- (8) Turn ON the Controller.

- (9) Calibrate all the Joints.

For details, refer to *Maintenance 8. Calibration.*



## 7.4 Replacing the Encoder Board 2

### Removal

- (1) Remove the Arm #2 outside cover.

For details, refer to *Maintenance 3. Covers*.

Remove the connectors connected to the encoder board 2.

Connector: EB02\_CN1  
EB0x\_CN2 (Joint #2 side)  
EB0x\_CN2 (Joint #3 side)

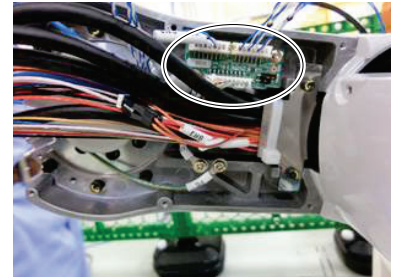

**NOTE**  Be careful that the jumper pins on the board do not come off.

- (2) Remove the encoder board 2.

Cross recessed head screw: 2-M3×6

**NOTE**  Be careful not to drop the screws inside the Manipulator while removing them.



- Improper jumper pin settings may result in occurrence of the errors such as below.  
Example:  
5042: Position error overflow in high power state.  
Check the power cable connection, the robot, the driver and the motor.  
When replacing the boards, be careful not to configure them incorrectly.

### Installation

- (1) Change the position of the jumper pin on the encoder board 2 to “1-2 short”.

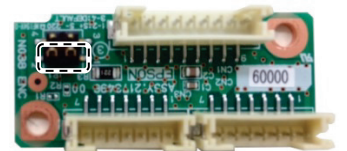

- (2) Install the encoder board 2 to the Arm #2.

Cross recessed head screw: 4-M3×6

Tightening torque:  $0.45 \pm 0.05 \text{ N}\cdot\text{m}$

**NOTE**  Be careful not to drop the screws inside the Manipulator while removing them.

- (3) Connect the connectors to the encoder board 2.

Connector: EB02\_CN1  
EB0x\_CN2 (Joint #2 side)  
EB0x\_CN2 (Joint #3 side)

**NOTE**  Be careful that the jumper pins on the board do not come off.

- (4) Install the Arm #2 outside cover.

For details, refer to *Maintenance 3. Covers*.

- (5) Turn ON the Controller.

- (6) Calibrate the Joints #2 and #3.

For details, refer to *Maintenance 8. Calibration*.

## 7.5 Replacing the Encoder Board 3

### Removal

- (1) Remove the Arm #3 upper cover.

For details, refer to *Maintenance 3. Covers*.

- (2) Remove the Arm #3 outside cover.

Hexagon socket head cap bolt: 4-M3×15

For details, refer to *Maintenance 3. Covers*.

**NOTE**  The cables are connected to the Arm #3 outside cover. When removing the cover, be careful not to pull the cables forcibly.

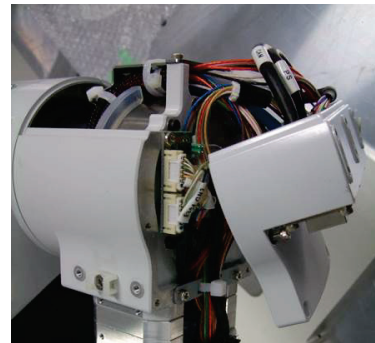
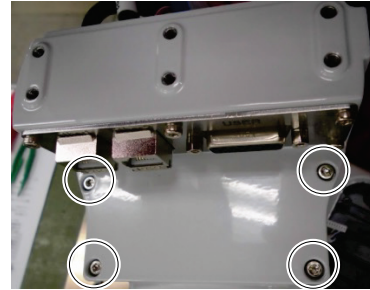

- (3) Remove the connectors connected to the encoder board 3.

Connector: EB04\_CN1, EB04\_CN3,  
EB0x\_CN2

**NOTE**  Be careful that the jumper pins on the board do not come off.

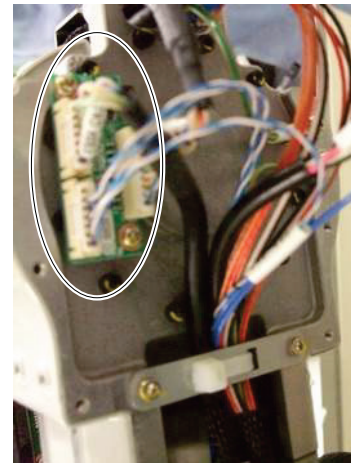

- (4) Remove the encoder board 3.

Cross recessed head screw: 2-M3×6

**NOTE**  Be careful not to drop the screws inside the Manipulator while removing them.

 <b>CAUTION</b>	<p>■ Improper jumper pin settings may result in occurrence of the errors such as below.</p> <p>Example:  5042: Position error overflow in high power state.</p> <p>Check the power cable connection, the robot, the driver and the motor.</p> <p>When replacing the boards, be careful not to configure them incorrectly.</p>
---	---

## Installation

- (1) Check that the jumper pin of the encoder board 3 is at “3-4 short”.





- (2) Install the encoder board 3 to the Arm #2.
- Cross recessed head screw: 2-M3×6
- Tightening torque:  $0.45 \pm 0.05 \text{ N}\cdot\text{m}$

NOTE  Be careful not to drop the screws inside the Manipulator while removing them.

- (3) Connect the connectors to the encoder board 3.
- Connector: EB04\_CN1, EB04\_CN3,  
EB0x\_CN2

NOTE  Be careful that the jumper pins on the board do not come off.

- (4) Install the Arm #3 outside cover.
- Hexagon socket head cap bolt: 4- M3×15
- Tightening torque:  $2.0 \pm 0.1 \text{ N}\cdot\text{m}$

NOTE  For details, refer to *Maintenance 3. Covers*.  
 Be careful not to get the cables caught in the base.

- (5) Install the Arm #3 upper covers.

For details, refer to *Maintenance 3. Covers*.

- (6) Turn ON the Controller.

- (7) Calibrate the Joints #4, #5, and #6.

For details, refer to *Maintenance 8. Calibration*.

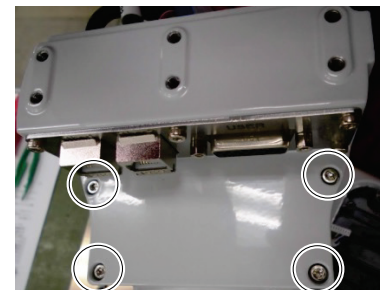
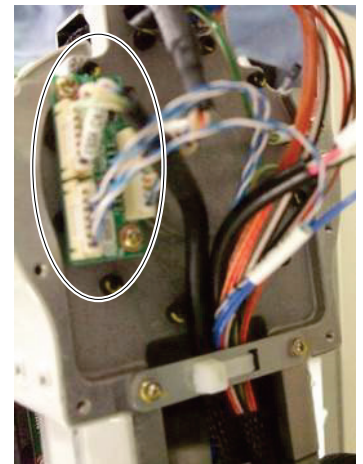

## 7.6 Replacing the Encoder Board 4

### Removal

- (1) Remove the Arm #4 left side cover.

For details, refer to *Maintenance 3. Covers*.

- (2) Remove the connectors connected to the encoder board 4.

Connector: EB05\_CN1, EB05\_CN3,  
EB0x\_CN2

**NOTE**  Be careful that the jumper pins on the board do not come off.

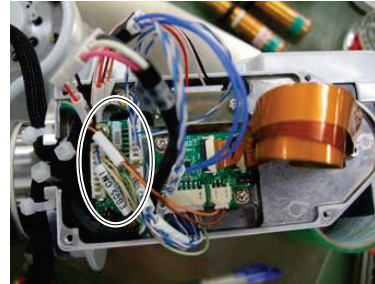

- (3) Remove the encoder board 4.

Cross recessed head screw: 2-M3×6

**NOTE**  Be careful not to drop the screws inside the Manipulator while removing them.



CAUTION

- Improper jumper pin settings may result in occurrence of the errors such as below.  
Example:  
5042: Position error overflow in high power state.  
Check the power cable connection, the robot, the driver and the motor.  
When replacing the boards, be careful not to configure them incorrectly.

### Installation

- (1) Check that the jumper pin of the encoder board 4 is at “3-4 short”.



- (2) Install the encoder board 4 to the Arm #4.

Cross recessed head screw: 2-M3×6

Tightening torque:  $0.45 \pm 0.05$  N·m

**NOTE**  Be careful not to drop the screws inside the Manipulator while installing them.

- (3) Connect the connectors to the encoder board 4.

Connector: EB05\_CN1, EB05\_CN3, EB0x\_CN2

**NOTE**  Be careful that the jumper pins on the board do not come off.

- (4) Install the Arm #4 left side cover.

For details, refer to *Maintenance 3. Covers*.

- (5) Turn ON the Controller.

- (6) Calibrate the Joints #5 and #6.

For details, refer to *Maintenance 8. Caribration*.

## 7.7 Replacing the Filter Board

### Removal

(1) Turn OFF the Controller.

(2) Remove the filter board unit.

Hexagon socket head cap bolt: 4-M4×8

**NOTE** The cables are connected to the filter board unit.  
 When removing the board, be careful not to pull the cables forcibly.

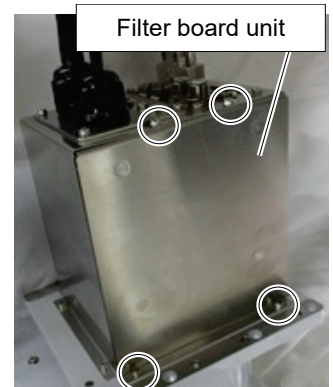

(3) Remove the connectors connected to the filter board.

Connector:

FIL\_CN1, FIL\_CN2, FIL\_CN3, FIL\_CN4

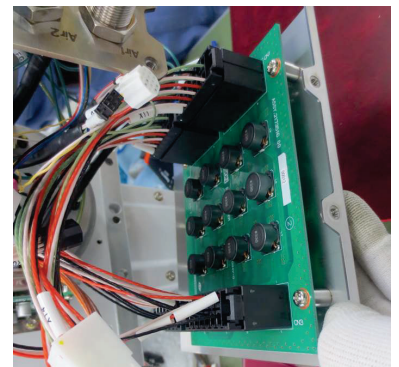

(4) Remove the filter board.

Cross recessed head screw: 4-M4×8

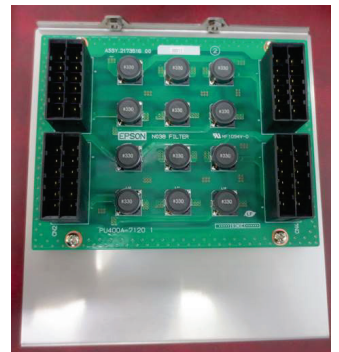

Installation

- (1) Install the filter board to the base of the filter board unit.

Cross recessed head screw: 4-M4×8

Tightening torque:  $0.6 \pm 0.1 \text{ N}\cdot\text{m}$



- (2) Connect the connectors to the filter board.

Connector:

FIL\_CN1, FIL\_CN2, FIL\_CN3, FIL\_CN4

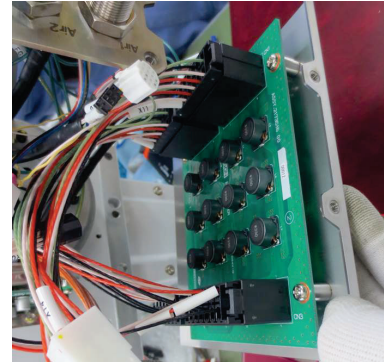

- (3) Install the filter board unit to the base.

Hexagon socket head cap bolt: 4-M4×8

Tightening torque:  $4.0 \pm 0.2 \text{ N}\cdot\text{m}$

NOTE



Be careful not to get the cables caught in the base.



- (4) Turn ON the Controller.
- (5) Check operation to see if the Manipulator's position and posture are out of position. Move the Manipulator to two or three points (poses) of the registered points.
- (6) If the Manipulator is out of position, calibrate all the joints and axes.

For details, refer to *Maintenance 8. Calibration*.

## 7.8 Replacing the Brake Board

### Removal

(1) Turn OFF the Controller.

(2) Remove the base cover.

For details, refer to *Maintenance 3. Covers*.

(3) Remove the M/C cable.

For details, refer to *Maintenance 4.4 Replacing the M/C Cable*.

(4) Remove the brake release connector.



(5) Remove the base.

Hexagon socket head cap bolt: 9-M4×8

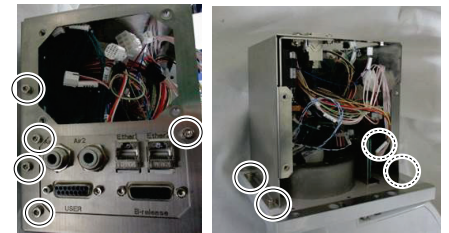

(6) Remove the connectors connected to the brake board.

Connector: BRK\_CN1, BRK\_CN2

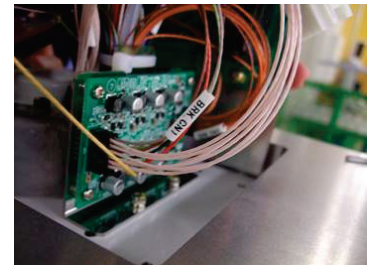

(7) Remove the brake board.

Cross recessed head screw: 4-M3×6

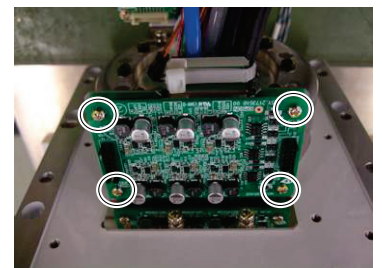

Installation

- (1) Install the brake board to the plate inside the base.

Cross recessed head screw: 4-M3×6

Tightening torque:  $0.45 \pm 0.05 \text{ N}\cdot\text{m}$

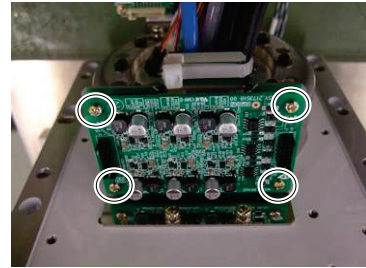

- (2) Connect the connectors to the brake board.

Connector: BRK\_CN1, BRK\_CN2

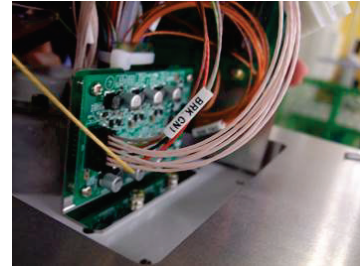

- (3) Install the base.

Hexagon socket head cap bolt: 9-M4×8

Tightening torque:  $4.0 \pm 0.2 \text{ N}\cdot\text{m}$

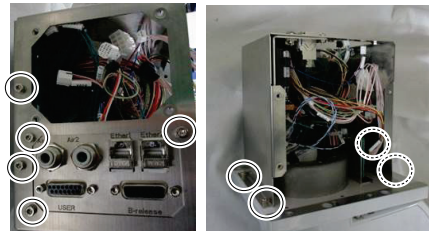

NOTE Be careful not to get the cables caught in the base.



- (4) Install the brake release connector.

NOTE The user cable connector and the brake release connector have the same shape. Be careful not to connect the wrong connector.



- (5) Install the M/C cable.

For details, refer to *Maintenance 4.4. Replacing the M/C Cable.*

- (6) Install the base cover.

For details, refer to *Maintenance 3. Covers.*

- (7) Turn ON the Controller.



## 7.9 Replacing the FPC board 1

### NOTE



Be careful that the jumper pins on the board do not come off.

### Removal

- (1) Remove the Arm #4 left side cover.

For details, refer to *Maintenance 3. Covers*.

- (2) Remove the connectors connected to the FPC board 1.

Connector: FL01\_CN1, FL\_CN2

- (3) Remove the FPC board 1.

Cross recessed head screw: 2-M3×6

### NOTE



Be careful not to drop the screws inside the Manipulator while removing them.

### NOTE



The FPC are connected to the board.  
When removing them, be careful not to pull forcibly.

- (4) Remove the FPC from the FPC board 1.

### NOTE



Lift up the black latch on the board side connectors to remove the connectors.  
If the connectors are removed while the latch is not lifted up, the FPC may get damaged.

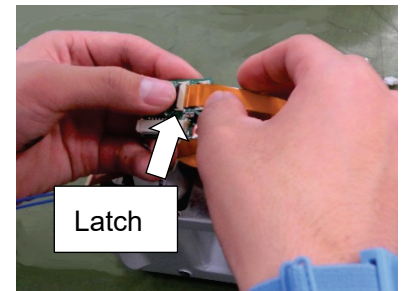
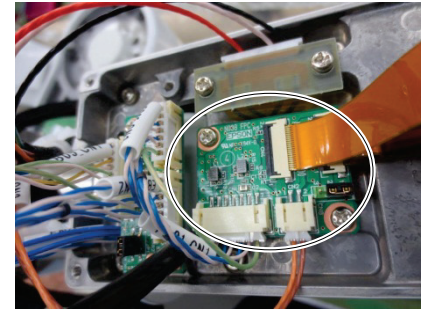

 <b>CAUTION</b>	<p>■ Improper jumper pin settings may result in occurrence of the errors such as below.                  Example:                  5042: Position error overflow in high power state.                  Check the power cable connection, the robot, the driver and the motor.                  When replacing the boards, be careful not to configure them incorrectly.</p>
---	---

**NOTE**  
 Be careful that the jumper pins on the board do not come off.

**Installation** (1) Check that the jumper pin of the FPC board 1 is at “1-2 short”.

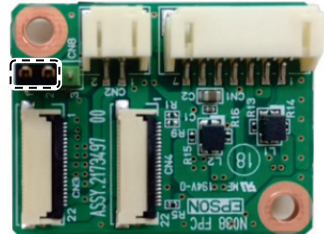

(2) Connect the FPC to the FPC board 1.

**NOTE**  
 Layer the FPC on top of one another neatly so that the orange parts come to the front side of the board (where two connectors are located). See the photo for the installation order of FPC. (1, 3, and 4 are at the back side of the board)

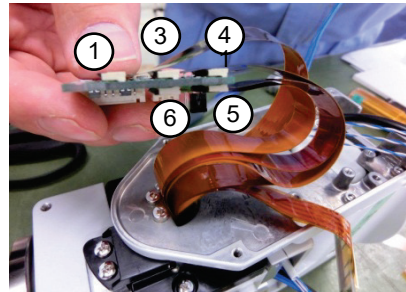

Insert the FPC with the black latch lifted up, and then lower the latch to fix it.

Connect the FPC correctly.

Operating the Manipulator with incorrect connection may cause malfunction.

Insert the FPC connectors firmly to the end.

(3) Install the FPC board 1 to the Arm #4.  
 Cross recessed head screw: 2-M3×6  
 Tightening torque: 0.45 ± 0.05 Nm

**NOTE**  
 Be careful not to drop the screws inside the Manipulator while removing them.

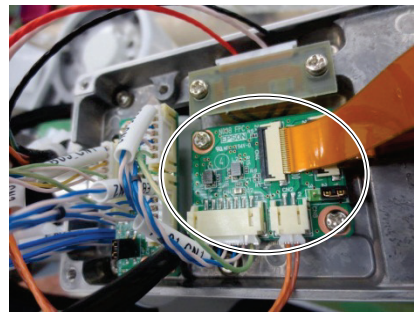

(4) Connect the connectors to the FPC board 1.  
 Connector: FL01\_CN1, FL\_CN2

(5) Install the Arm #4 left side cover.  
 For details, refer to *Maintenance 3. Covers*.

(6) Calibrate the Joints #5 and #6.  
 For details, refer to *Maintenance 8. Calibration*.

## 7.10 Replacing the FPC Board 2

### NOTE



Be careful that the jumper pins on the board do not come off.

### Removal

- (1) Remove the Arm #5 outside cover.

For details, refer to *Maintenance 3. Covers*.

- (2) Remove the connectors connected to the FPC board 2.

Connector: EB0x\_CN2, FL\_CN2

- (3) Remove the FPC board 2.

Cross recessed head screw: 2-M3×6

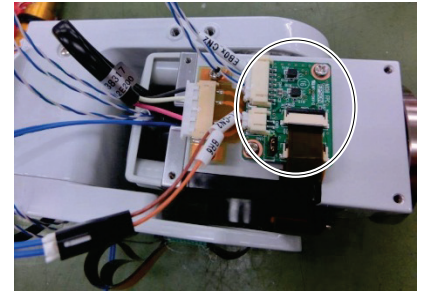

### NOTE



Be careful not to drop the screws inside the Manipulator while removing them.

### NOTE



The FPC are connected to the board.  
When removing them, be careful not to pull forcibly.

- (4) Remove the FPC from the FPC board 2.

### NOTE



Lift up the black latch on the board side connectors to remove the connectors.  
If the connectors are removed while the latch is not lifted up, the FPC may get damaged.

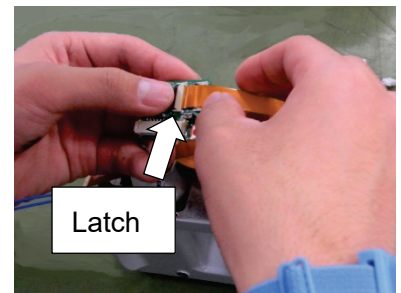

 <b>CAUTION</b>	<p>■ Improper jumper pin settings may result in occurrence of the errors such as below.                  Example:                  5042: Position error overflow in high power state.                  Check the power cable connection, the robot, the driver and the motor.                  When replacing the boards, be careful not to configure them incorrectly.</p>
---	---

**NOTE**  Be careful that the jumper pins on the board do not come off.

**Installation** (1) Change the position of the jumper pin on the FPC board 2 to “2-3 short”.

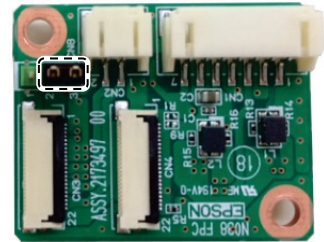

(2) Connect the FPC to the FPC board 2.

**NOTE**  Layer the FPC on top of one another so that the black parts come to the back side of the board (where two connectors are located). See the photo for the installation order of FPC.

Insert the FPC with the black latch lifted up, and then lower the latch to fix it.

Connect the FPC correctly.  
 Operating the Manipulator with incorrect connection may cause malfunction.

Insert the FPC connectors firmly to the end.

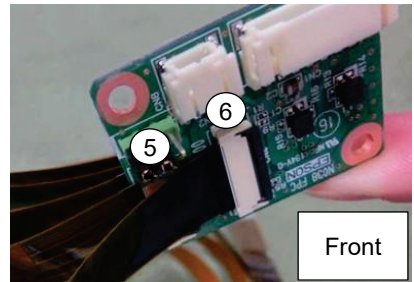
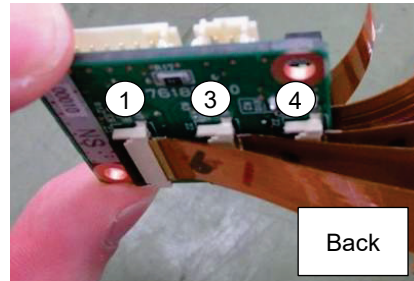

(3) Install the FPC board 2 to the Arm #5.  
 Cross recessed head screw: 2-M3×6  
 Tightening torque: 0.45 ± 0.05 Nm

**NOTE**  Be careful not to drop the screws inside the Manipulator while removing them.

(4) Connect the connectors to the FPC board 2.

Connector: EB0x\_CN2, FL\_CN2

(5) Install the Arm #5 side cover.

For details, refer to *Maintenance 3. Covers*.

(6) Calibrate the Joints #5 and #6.

For details, refer to *Maintenance 8. Calibration*.

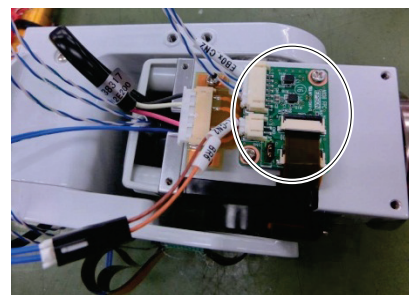

## 7.11 Replacing the LED Board

### Removal

- (1) Turn OFF the Controller.
- (2) Remove the Arm #1 outside cover.

For details, refer to *Maintenance 3. Covers*.

**NOTE**  The cables are connected to the Arm #1 outside cover. When removing the cover, be careful not to pull the cables forcibly.

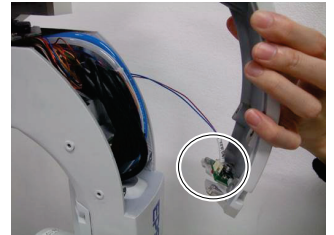

- (3) Remove the connector connected to the LED board.

Connector: LED\_CN1

- (4) Remove the LED plate.

Cross recessed head screw: 2-M3×6

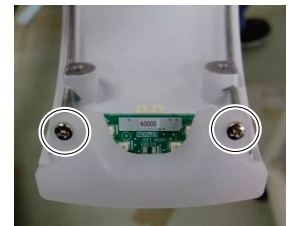

- (5) Remove the LED board.

Cross recessed head screw: 2-M3×6



Installation

- (1) Install the LED board to the Arm #1 outside cover.

Cross recessed head screw: 2-M3×6

Tightening torque:  $0.45 \pm 0.1$  N·m

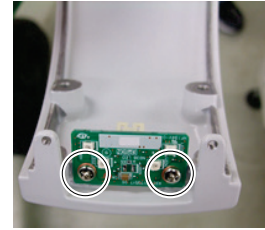

- (2) Install the LED plate to the Arm #1 outside cover.

Cross recessed head screw: 2-M3×6

Tightening torque:  $0.45 \pm 0.1$  N·m



- (3) Connect the connector to the LED board 1.

Connector: LED\_CN1



- (4) Install the Arm #1 outside cover.

For details, refer to *Maintenance 3. Covers*.

NOTE



Be careful not to get the cables caught in the base.

## 8. Calibration

### 8.1. Overview

After parts (actuator units, timing belts, etc.) or the battery board have been replaced, the Manipulator cannot perform positioning properly because a gap exists between the origin stored in each actuator unit and its corresponding origin stored in the Controller.

After replacing the parts, it is necessary to match these origins.

The process of aligning the two origins is called “Calibration”.

Note that calibration is not the same as teaching\*

\* “Teaching” means to teach the Controller coordinate points (including poses) anywhere in the operating area of the Manipulator.



WARNING

- To ensure safety, a safeguard must be installed for the robot system. For details on the safeguard, refer to the *Installation and Design Precautions* in the *Safety* chapter of the *EPSON RC+ User's Guide*.
- Before operating the robot system, make sure that no one is inside the safeguarded area. The robot system can be operated in the mode for teaching even when someone is inside the safeguarded area. The motion of the Manipulator is always in restricted (low speeds and low power) status to secure the safety of an operator. However, operating the robot system while someone is inside the safeguarded area is extremely hazardous and may result in serious safety problems in case that the Manipulator moves unexpectedly.

There are two methods to move the Manipulator during calibration.

- Releasing the Solenoid brake and moving the arms manually.

For details, refer to the *Setup & Operation 1.5 How to Move Arms with the Solenoid brake*.

- Moving the Manipulator using Jog & Teach.

For details of Jog & Teach, refer to the following manual.

*EPSON RC+ User's Guide 5.11.1 [Robot Manager] Command (Tools Menu)-[Jog and Teach]*

Moving the Manipulator while releasing the Solenoid brake involves risk as described below.



CAUTION

- Normally, release the brake of joints one by one. Take extra care if you need to release the brakes of two or more joints simultaneously. Releasing the brakes of two or more joints simultaneously may cause hands and fingers to be caught and/or equipment damage to or malfunction of the Manipulator as the arms of the Manipulator may move in unexpected directions.
- Be careful of the arm falling when releasing the brake. While the brake is being released, the Manipulator's arm falls by its own weight. The arm falling may cause hands and fingers to be caught and/or may cause equipment damage to or malfunction of the Manipulator.

Also, pay attention to the following points at the encoder initialization.

 <b>CAUTION</b>	<ul style="list-style-type: none"> <li>■ The Joint #1 and Joint #4 have no mechanical stops and they may be rotated more than 360 degrees. If the encoder initialization is performed with improper posture, the Manipulator moves outside the operation range. If the Manipulator was moved outside the operation range, the internal wiring may be damaged by being twisted or pinched and it may result in Manipulator malfunction.</li> </ul>
---	---

**NOTE**  When the origin positions of the Joint #1 and #4 are uncertain, check torsion of the internal cables. The origin positions are where the Manipulator has the internal cables not twisted at the basic orientation described in *Setup & Operation 3.8 Checking the Basic Orientation*.

Torsion of the internal cables can be checked by removing the following covers.

Joint #1 : Joint #1 cover, Arm #1 cover

Joint #4 : Arm #3 side covers, Arm #3 upper side covers



When J1: +180°  
Black cable is on the right side

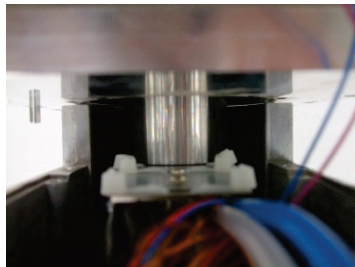

When J1: 0°  
Black cable cannot be seen

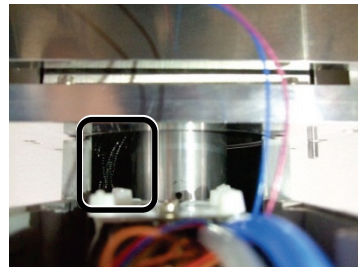

When J1: -180°  
Black cable is on the left side

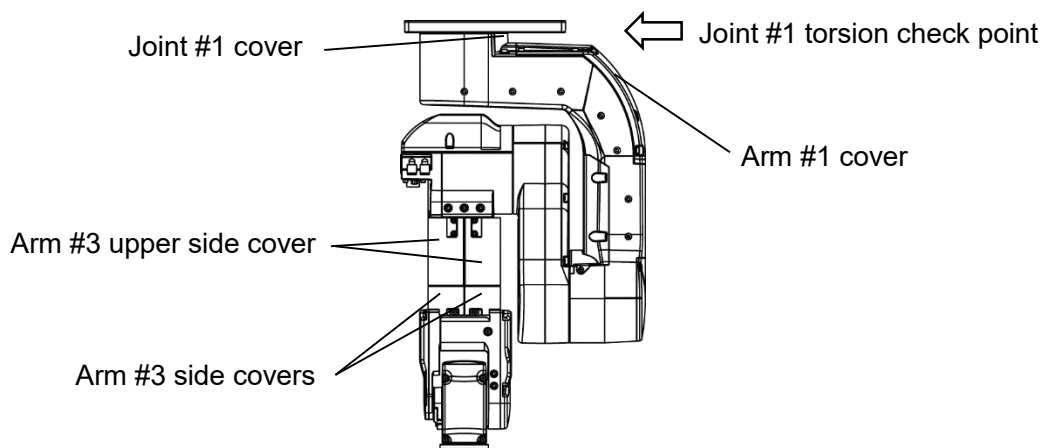

When J4: +180°



When J4: 0°



When J4: -180°



NOTE  

- For details about the basic orientation, refer to *Setup & Operation 3.8 Checking the Basic Orientation*.
- The Joint #5 cannot be calibrated alone due to the structure of the Manipulator. Make sure you calibrate joint #5 and #6 at the same time.

Calibration Flowchart

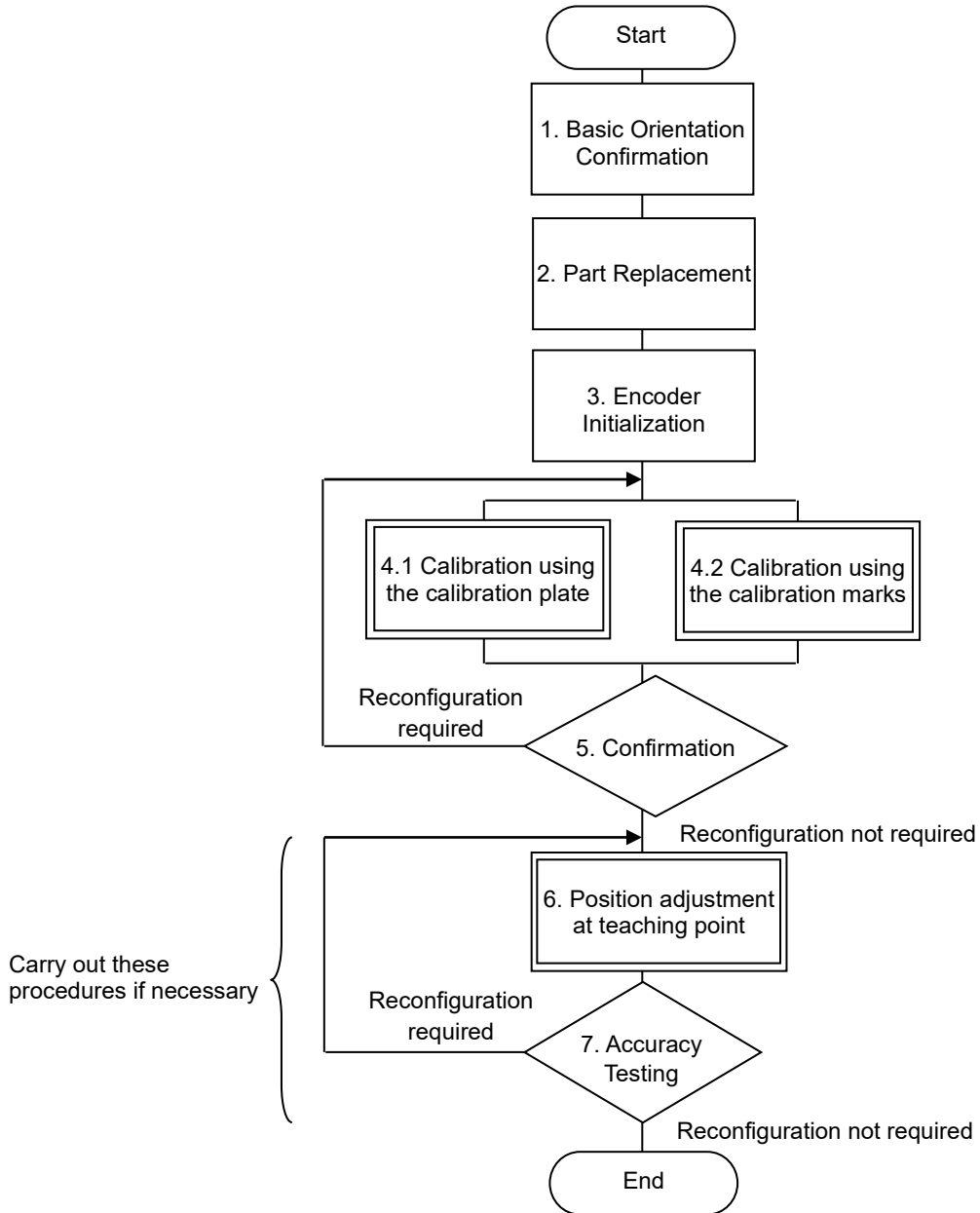

## 8.2. Calibration Procedure

### Calibration methods

There are two methods to perform calibration.

Calibration using the calibration plates:

By aligning the Manipulator to the calibration plate, all the axes can be calibrated at once.

Calibration using the calibration marks:

By performing calibration at the points where the calibration marks match each other, the axes can be calibrated individually. When the Manipulator cannot have the basic orientation, calibration by this method is available by defining the reference orientation and putting the “match marks”.

### Command Input

Command execution is required in some calibration procedures.

Select the EPSON RC+ menu-[Tools]-[Command Window].

This step is omitted in the calibration procedures.

## Jog Motion

Setting of the jog motion is required in some calibration procedures.

Select EPSON RC+ menu-[Tools]-[Robot Manager] and select the [Jog & Teach] page.

The panel, window, and page above are indicated as [Jog & Teach] in the calibration procedures.

Follow the steps 1 to 5 to calibrate the Manipulator.

### 1. Basic Orientation Confirmation

The calibration is performed with the basic orientation of the Manipulator.

For details about the basic orientation, refer to *Setup & Operation 3.8 Checking the Basic Orientation*.

When the Manipulator cannot have the basic orientation, define the reference orientation in advance, and record the point data. Also, put the “match marks” to indicate the orientation.

The coordinate points including the Arm orientation are referred to as “points”, and the data of the points are called “point data” in the EPSON RC+.

Follow the steps 1 through 3, and then choose either method at the step 4.

Calibration at Basic Orientation:

Step 4-1. Calibration using the calibration plate

Calibration using the calibration marks:

Step 4-2. Calibration using the calibration marks

### 2. Part Replacement

Replace the parts as instructed in this manual.

Be careful not to injure yourself or damage parts during part replacement.

### 3. Encoder Initialization:

Connect the cables and turn ON the Controller while all joints are in the motion range.

The error message “Encoder alarm has occurred. Check robot battery. EPSON RC+ must be restarted.” will be displayed on the EPSON RC+ window.

Initialize the encoder at the current Manipulator position and reset the error.

Initialize the encoder using one of the following procedures.

Execute the following command in the [Command Window] to initialize the encoder.



```
>Encreset [The joint number (1 to 6) of the encoder to be reset]
```

Select EPSON RC+ menu-[Tools]-[Controller], then click <Reset Controller>.

4. Calibration

4-1. Calibration using the calibration plate

Prepare the following parts to perform calibration using the calibration plate.

Parts	Quantity
Calibration plate	1
Arm #4 offset jig	1
Arm #6 offset jig	1
Hexagon socket head cap bolts (M4×15)	8
Hexagon socket head cap bolts (M4×20)	4
J1 origin point pin	1
Hexagon socket head cap bolts (M2.5×20)	1
Plain washer for M4 (small washer)	8

4-1-1 Move the Manipulator to the basic orientation.



Set the jog mode to “Joint” in the [Jog & Teach] panel, and then move the Manipulator in Jog motion so that each axis has the basic orientation (0 pulse position).

At this moment, move the Manipulator to have the posture as shown in the photo on the right in order to install the calibration plate easily.

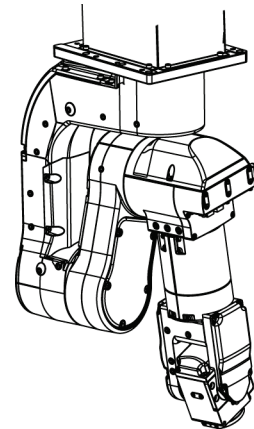

4-1-2 Use the calibration plate to align each joint to the origin posture.



Be careful not to get injured by getting hands and fingers caught or due to the fall of the calibration plate.

Be careful of the arm falling or rotating when releasing the brake.

Turn OFF the motors, set the calibration pin to the base plate, and set the offset jigs to the Arms #4 and #6.

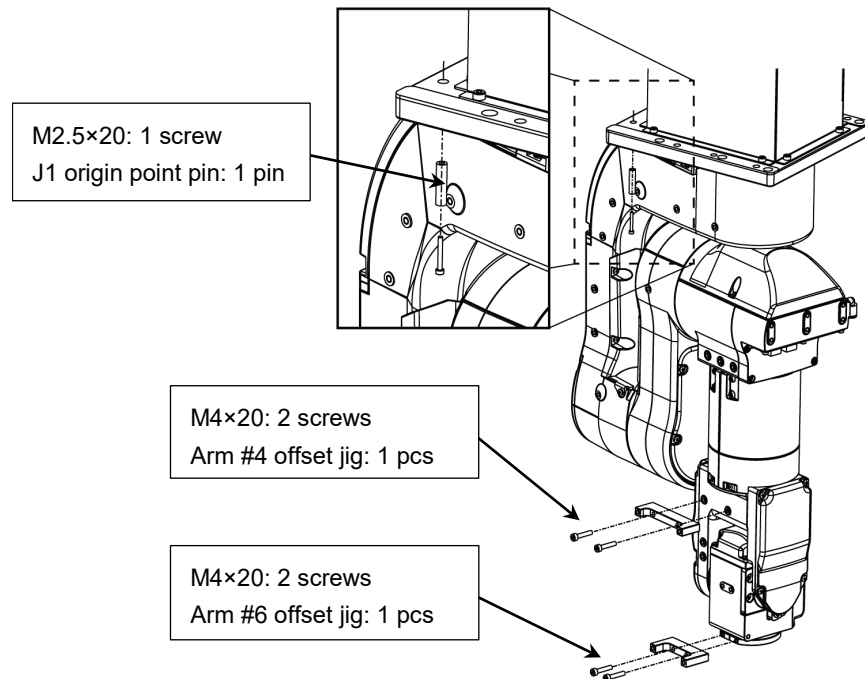

Rotate the Arm #1 so that the J1 origin point pin comes inside the calibration plate, and fix the calibration plate to the Arm #1 with the three screws.

M4×15: 3 screws

M4 washer: 3 washers

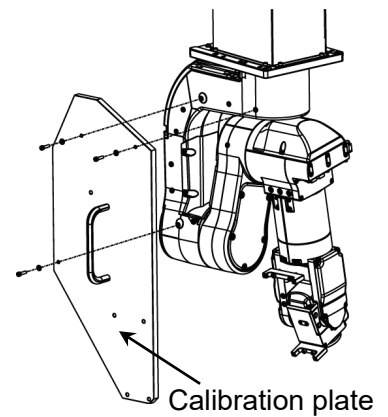

EPSON  
RC+

Release the Joint #2 brake.

Brake release command

>Brake Off, 2

Rotate the Arm #2 by hand to align it to the calibration plate, and then tighten the screws where the Arm touches the calibration plate.

M4×15: 1 screws

M4 washer: 1 washer

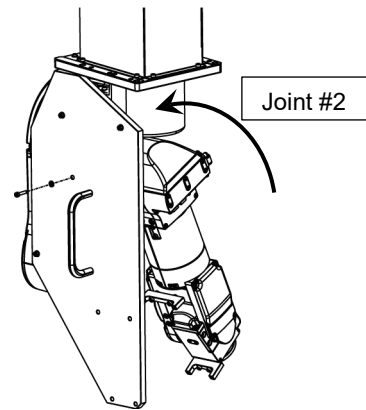

EPSON  
RC+

Release the Joint #3 and #4 brakes.

Brake release command

>Brake Off, 3,4

Rotate the attachment installed on the Arm #4 by hand to align the arm to the calibration plate, and then tighten the screws where the Arm touches the calibration plate.

Align the Manipulator so that the surface of the attachment fits that of the calibration plate as much as possible.

M4×15: 2 screws

M4 washer: 2 washers

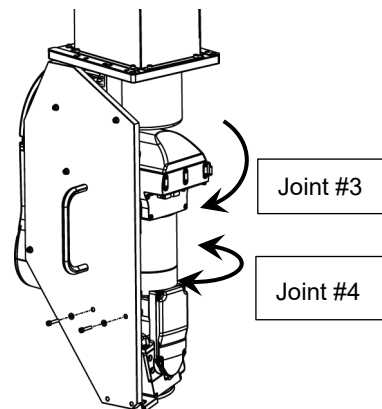

EPSON  
RC+

Release the Joint #5 and #6 brakes.

Brake release command

>Brake Off, 5,6

Rotate the attachment installed on the Arm #6 by hand to align the arm to the calibration plate, and then tighten the screws where the Arm touches the calibration plate.

Align the Manipulator so that the surface of the attachment fits that of the calibration plate as much as possible.

M4×15: 2 screws

M4 washer: 2 washers

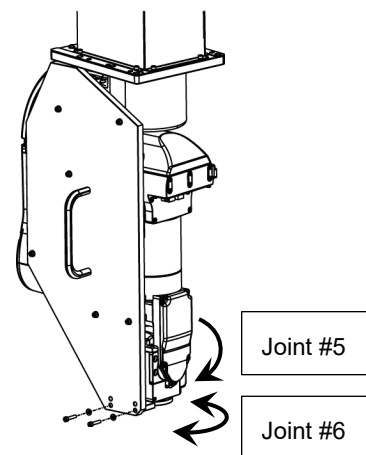

Rotate the Arm #1 to one direction by hand until the pin installed on the base plate touches the calibration plate.

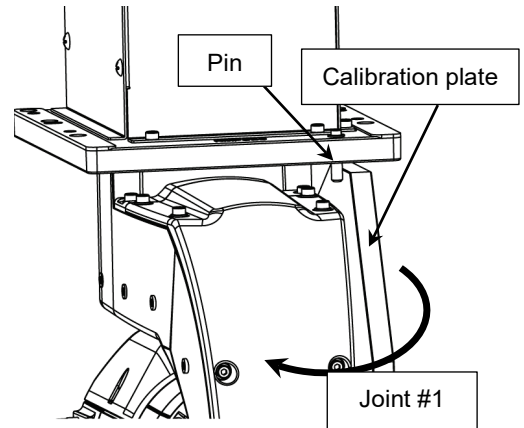

#### 4-1-3 Initialize the Encoder.

EPSON  
RC+

Execute the command in the [Command Window] according to the joint to initialize the encoder as follows.

```
Joint #1 >Encreset 1
Joint #2 >Encreset 2
Joint #3 >Encreset 3
Joint #4 >Encreset 4
Joint #5 >Encreset 5, 6
Joint #6 >Encreset 6
```

Restart the Controller.

Select EPSON RC+ menu-[Tools]-[Controller], then click <Reset Controller>.

#### 4-1-4 Execute the origin point setting.

EPSON  
RC+

Execute the following command in the [Command Window] to specify the pulse values to be set as the origin point.

```
>calpls 0,0,0,0,0,0
* Manipulator will not move.
```

Then, execute the following command in the [Command Window] to set the specified pulse values to the encoder according to the joint to set the origin point.

```
Joint #1 >Calib 1
Joint #2 >Calib 2
Joint #3 >Calib 3
Joint #4 >Calib 4
Joint #5 >Calib 5, 6
Joint #6 >Calib 6
```

Remove the calibration plate.

When removing it, be careful of the fall of the calibration plate.



When the origin of the Joint #5 is calibrated, the Joint #6 will be out of position.  
 (Due to the structure of the Manipulator, any offset in the position of the Joint #5 affects the Joint #6.)

Calibrate the origin of the Joint #6 together when calibrating the Joint #5.

Calibration marks of each joint

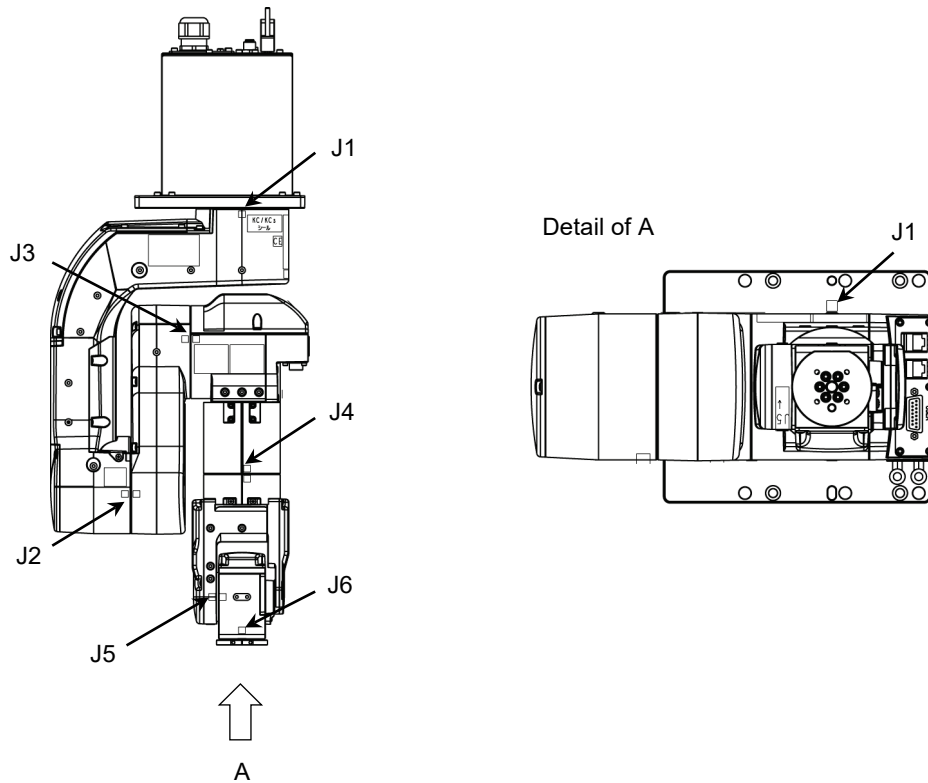

4-2. Calibration using the calibration marks



4-2-1 Align the calibration marks of the target joint

Set the jog mode to “Joint” in the [Jog & Teach] panel, and then move the Manipulator in Jog motion so that the calibration marks on the target joint match as much as possible.

See the above figure for location of the calibration marks.

When the Manipulator cannot have the basic orientation, move it to the predetermined reference position by aligning the “match marks”.



## 4-2-2 Initialize the Encoder.



Execute the command in the [Command Window] according to the joint to adjust as follows.

```
Joint #1 >Encreset 1
Joint #2 >Encreset 2
Joint #3 >Encreset 3
Joint #4 >Encreset 4
Joint #5 >Encreset 5, 6
Joint #6 >Encreset 6
```

Restart the Controller.

Select EPSON RC+ menu-[Tools]-[Controller], then click <Reset Controller>.

## 4-2-3 Execute the origin point setting.



Execute the following command in the [Command Window] to specify the pulse values to be set as the origin point.

```
>calpls J1 pulse, J2 pulse, J3 pulse, J4 pulse, J5 pulse, J6 pulse
```

\* Manipulator will not move.

Specify the pulse values that are “0” when the Manipulator is aligned to the calibration marks, or the values recorded at the predetermined reference orientation (where the match marks are aligned) to the command parameters.

If the point data for the reference orientation is “P1”, the command parameters can be specified as follows

```
>calpls ppls(P1,1), ppls(P1,2), ppls(P1,3), ppls(P1,4),
ppls(P1,5), ppls(P1,6)
```

Then, execute the following command in the [Command Window] to set the specified pulse values to the encoder according to the joint to set the origin point.

```
Joint #1 >Calib 1
Joint #2 >Calib 2
Joint #3 >Calib 3
Joint #4 >Calib 4
Joint #5 >Calib 5, 6
Joint #6 >Calib 6
```

## NOTE



When the origin of the Joint #5 is calibrated, the Joint #6 will be out of position. (Due to the structure of the Manipulator, any offset in the position of the Joint #5 affects the Joint #6.)

Calibrate the origin of the Joint #6 together when calibrating the Joint #5.

## 5. Confirmation

Move the arm to several points to check if the arm moves to the original positions properly.

Teach points if fine adjustment is necessary.

Position adjustment by teaching point (perform if necessary)



After the calibration, move the Manipulator to the selected point data by jogging in [Jog & Teach].

When the selected point data is “P1”,

Execute “Motor On” in [Control Panel] and execute “Go P1” in [Jog & Teach].



Adjust the calibrated joints accurately by jog command so that the end effector is aligned to the selected point data position.

\*When the Joint #5 is calibrated, adjust the Joint #5 and #6.

Select the “Joint” jog mode from [Jog & Teach] to change and adjust the angle of the target joint in the jog motion.

Set the pulse values again at the adjusted point.

Execute the following command in the [Command Window] to specify the pulse values to set.

```
>calpls J1 pulse, J2 pulse, J3 pulse, J4 pulse, J5 pulse, J6 pulse
```

\* Manipulator will not move.

Specify the pulse values of the selected point data to the command parameters.

If the point data for the reference orientation is “P1”, the command parameters can be specified as follows

```
>calpls ppls(P1,1), ppls(P1,2), ppls(P1,3), ppls(P1,4),
ppls(P1,5), ppls(P1,6)
```

\* Manipulator will not move.

Then, execute the following command in the [Command Window] to set the specified pulse values to the encoder according to the joint to set the origin point.

```
Joint #1 >Calib 1
Joint #2 >Calib 2
Joint #3 >Calib 3
Joint #4 >Calib 4
Joint #5 >Calib 5, 6
Joint #6 >Calib 6
```

## 7. Accuracy Testing

Move the Manipulator to a different pose (point) to verify whether it moves back to the original position. If accuracy is inadequate, it is necessary to re-calibrate the origin using a different pose (point). You must set the pose (point) again if the Manipulator does not move back to the original position after re-calibration.

## 9. Maintenance Parts List

Name	Code	Note	Reference in Maintenance	Overhaul **	
Actuator unit	Joint #1	1696678	100 W, unit	5.1	✓
	Joint #2	1696697	100 W, unit	5.2	✓
	Joint #3	1696698	100 W, unit	5.3	✓
	Joint #4	1696699	30 W, unit	5.4	✓
	Joint #6	1696701	15 W, unit	5.7	✓
	Joint #5, 6	1696703	30 W/15 W, unit	5.6	✓
Motor unit		1696700	30 W, unit	5.5.1	✓
Reduction gear unit*	Joint #5	1696702	Unit	5.5.2	✓
Timing belt		1698992		5.5.3	✓
Belt tensile jig		1696718	Assembly jig	4.1, 4.2, 5.5, 5.5.2, 5.5.3, 5.7	
Battery set		2172925	(2 lithium metal batteries for replacement)	6.1	
Battery board		2173216		6.2	

\* Reduction Gear Unit: A reduction gear unit consists of the following three parts.  
Replace the following parts for each.

### Waveform generator

The waveform generator consists of an ellipsoidal cam and ball bearings on outer circumference. The inner ring of the bearings is secured to the cam, while the outer ring is capable of flexible deformation through the ball bearings.

### Flexspline

A thin, elastic, cup-shaped metal body with gear teeth around the outer circumference of the opening.

### Circular spline

A rigid, ring-shaped body with gear teeth on the inner circumference. The circular spline has two more teeth than the flexspline does.

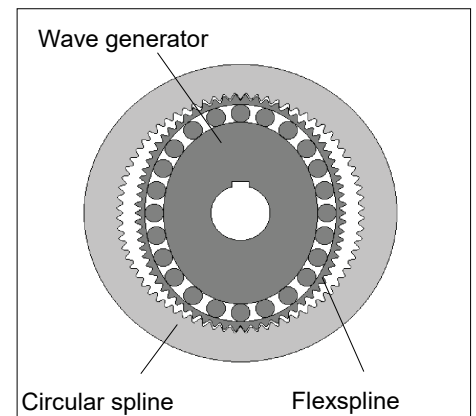

The splines are greased. Be sure to keep the grease from being attaching to the clothes.

### \*\* Overhaul

As a rough indication, perform overhaul (parts replacement) before reaching 20,000 operation hours of the Manipulator.

The operation hours can be checked in [Controller Status Viewer] dialog box - [Motor On Hours].

For details, refer to *Maintenance 2.2 Overhaul (Parts Replacement)*.

Maintenance 9. Maintenance Parts List

Name		Code	Note	Reference in Maintenance
Grease ***	Joint #1, 2, 3: SK-1A	-	For purchasing the grease, please contact the supplier of your region.	2.1.2, 2.3
	Joint #4, 5, 6: SK-2	-		
	Cable: GPL-224	-		4, 5

\*\*\* Due to the chemicals regulations of individual countries (the UN GHS), we are requesting our customers to purchase grease required for maintenance from the manufacturers listed in the table below as of April 2015.

Regarding purchase of the grease and other materials, please contact the following manufacturers.

If there is anything unclear, please contact the supplier of your region.

Product name	Manufacturer	URL
Harmonic Grease SK-1A Harmonic Grease SK-2	Harmonic Drive Systems Inc.	<a href="http://www.harmonicdrive.net/">http://www.harmonicdrive.net/</a>
Krytox®GPL-224	DuPont	<a href="http://www2.dupont.com/Our_Company/en_US/worldwide/us_country.html">http://www2.dupont.com/Our_Company/en_US/worldwide/us_country.html</a>

Name		Code	Note	Reference in Maintenance
Control Board		2138032		7.1, 7.2
FPC unit		1696704		4.3
FPC case		1685554		4.3
FPC board		2179138		7.9, 7.10
LED plate		1685535		7.11
LED board		2178376		
Encoder board		2179137		7.3, 7.4, 7.5, 7.6
Brake board		2178379		7.8
Filter board		2178380		7.7
O-ring	Joint #1, 2	1706460	Wire diameter ø 0.9mm, Inner diameter ø 67.0mm	5.1,5.2
	Joint #3	1686826	Wire diameter ø 1.78 mm Inner diameter ø 69.57 mm	5.3
	Joint #4, 5	1686825	Wire diameter ø 1.5mm Inner diameter ø 51.0mm	5.4, 5.5, 5.6
	Joint #6	1686862	Wire diameter ø 1.0mm Inner diameter ø 36.0mm	5.7
M/C cable	3 m	Straight	1696711	4.4
		L-shaped	1696714	
	5 m	Straight	1696712	
		L-shaped	1696715	
	10 m	Straight	1696713	
		L-shaped	1696716	
	15 m	Straight	1745266	
		L-shaped	1745268	
20 m	Straight	1745267		
	L-shaped	1745269		
Cable unit	HP_CABLE_A_UNIT	2186101		4.1

Name		Code	Note	Reference in <i>Maintenance</i>	
Relay cable	HP Harness A 01	2176213		4.2	
	HP Harness A 02	2176214			
	HP Harness A 03	2176215			
	HP Harness A 04	2176216			
	HP Harness A 05	2176217			
	HP Harness A 06	2176218			
	HP Harness A 07	2176220			
Brake release connector	HP_Harness_A_SW1	2176222		4.1, 4.2	
Wire tie	AB150	1675754	1 bag (100 ties: white)		
	AB200	1684328	1 bag (100 ties: white)		
Cover	Arm #1	Joint #1 cover	1685530	Plastic cover *	3
		Joint #2 cover	1685531		
		Arm #1 inside cover.	1696705		
		Joint #2 outside cover	1685538		
		LED plate	1685535		
	Arm #2	Arm #2 inside cover.	1685539		
		Joint #3 cover	1685540		
		Arm #2 outside cover	1696706		
	Arm #3	Arm #3 upper cover.	1696707		
		Arm #3 side cover	1696708		
	Arm #4	Arm #4 left side cover	1696709		
		Arm #4 right side cover	1685545		
	Arm #5	Arm #5 upper cover.	1685547		
		Arm #5 side cover	1696710		
Pad	Arm #4 pad	1686754		5.4, 5.5	
	Arm #6 pad	1686773		5.7	
Calibration mark		1692799		8	
Air fittings	Elbow	1644177	KQ2L06-M5N		
	Straight	1636156	KQ2H06-M5N		

\* Covers of metal are not the maintenance parts.

## 10. Option Parts List

Name	Code	Note	Reference in <i>Setup &amp; Operation</i>
Brake release unit (with cable and M/C short connector)	R12NZ900N4	For Europe (200V)	6.1
	R12NZ900N5	For U.S. & Japan (100V)	
MC short connector	R12NZ900N7	For brake release unit	
Camera plate unit	R12B031922	Common to C3 and C4 (R12NZ9003F)	6.2
Tool adapter (ISO flange)	R12NZ900PZ		6.3
Standard user connector kit	D-sub	R12NZ900LX	6.4
Calibration plate	R12NZ900Q1		6.7
Table top mount bracket	R12NZ900Q2		6.6
Wiring guide	R12NZ900Q3		6.5