

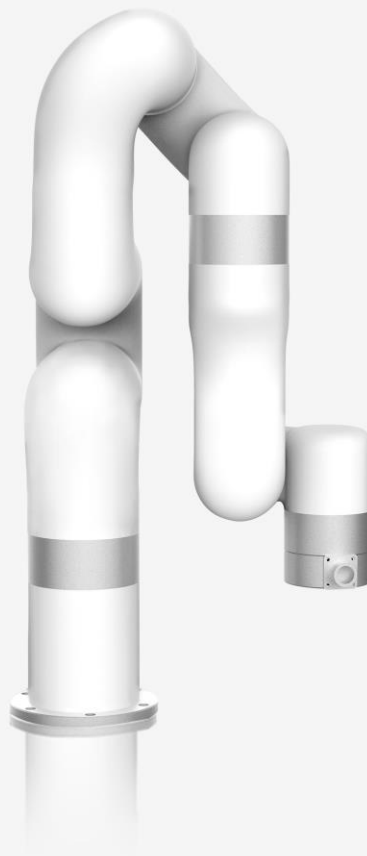

UFACTORY **XARM**

USER MANUAL



SHENZHEN UFACTORY CO., LTD

V1.6.1

Table

Table	2
Preface.....	9
Product Information.....	9
Main Contents of the Manual.....	10
Terms and Definitions.....	10
xArm Motion Parameters.....	14
Unit Definition.....	15
Additional Information.....	16
Safety Precautions	16
xArm User Manual-Hardware Section	24
1. Hardware Installation Manual.....	24
1.1. The Hardware Composition of xArm.....	24
1.1.1. Hardware Composition.....	24
1.1.2. Emergency Stop Button.....	25
1.1.3. Control Box Description.....	27
1.2. Robot Installation	27
1.2.1. Safety Guidelines for the Robot Environment.....	27
1.2.2. Robot Installation.....	28
1.3. Power Supply for the Robotic Arm.....	35
1.3.1. Preparation before Power On.....	35

1.3.2. Power On	36
1.3.3. Shut Down the Robotic Arm System	37
2. Electrical Interface	39
2.1. AC Control Box	39
2.1.1. Connect the Control Box to the Robotic Arm.....	39
2.1.2. Power Connection	39
2.1.3. Definition of the Robotic Arm Industrial Connector	41
2.2. DC Control Box.....	41
2.2.1. External Interfaces of Control Box	41
2.2.2. Definition of Industrial Connector	42
2.2.3. Specification of External Power	43
2.2.4. Electrical Alarms and Cautions.....	43
2.3. End-Effector I/O	44
2.3.1. Digital Output.....	46
2.3.2. Digital Input	47
2.3.3. Tool Analog Input	48
2.4. Control Box Electrical IO.....	50
2.4.1. General Specifications for all Digital I/O.....	50
2.4.2. Dedicated Safety I/O.....	53
2.4.3. General Digital I/O Function	57
2.4.4. General Analog I/O.....	60
2.5. Communication Interface	61

2.5.1. RS-485 Communication.....	62
2.6. Ethernet TCP/IP	62
3. End-Effector.....	65
3.1. Gripper.....	65
3.1.1. Gripper Installation.....	66
3.1.2. The Flow of Gripper Movement.....	67
3.1.3. Precautions.....	67
3.2. Vacuum Gripper	69
3.2.1. Vacuum Gripper Installation.....	69
3.2.2. Turn On/Off Vacuum Gripper.....	71
xArm User Manual-Software Section	72
1. xArm Studio.....	72
1.1 Hardware Preparation.....	73
1.2 Connect to the Robotic Arm.....	74
1.2.1 The Robotic Arm Network Settings.....	74
1.2.2 IP Configuration	76
1.2.3 Connect to the Robotic Arm.....	79
1.2.4 Return to the Search Interface.....	81
1.3 xArm Studio Homepage.....	82
1.3.1 xArm Studio Homepage Parameters.....	82
1.3.2 5 Main Functional Modules of xArm Studio	83
1.3.3 Toolbar	83

1.4	Robotic Arm Setting.....	84
1.4.1	Motion Settings.....	84
1.4.2	End Effector	88
1.4.3	TCP Settings	91
1.4.4	I/O Settings.....	95
1.4.5	Safety Settings	101
1.4.6	Mounting.....	103
1.4.7	Timed Tasks	106
1.4.8	Coordinate System.....	108
1.4.9	Advanced Settings	110
1.4.10	System Settings	124
1.5	Live Control	133
1.5.1	Status Bar.....	133
1.5.2	Emergency Stop	134
1.5.3	Real Robot/ Simulation Robot.....	134
1.5.4	Manual Mode	135
1.5.5	Joint Motion.....	136
1.5.6	Linear Motion.....	137
1.5.7	Operation Mode	141
1.5.8	Zero Position, Initial Position.....	144
1.5.9	Speed Setting.....	144
1.6	Blockly Graphical Programming.....	146

1.6.1	Interface Overview	146
1.6.2	Blockly Workspace	148
1.6.3	Blockly Code Block	151
1.6.4	Setting	152
1.6.5	Motion	154
1.6.6	GPIO (Control Box and End tool interface)	156
1.6.7	End Effector	159
1.6.8	Application.....	161
1.6.9	Logic.....	161
1.6.10	Loop.....	163
1.6.11	Math.....	164
1.6.12	Text.....	164
1.6.13	Variable.....	165
1.6.14	Function.....	166
1.6.15	Set & Edit Motion Coordinates.....	167
1.6.16	Path Planning Guidelines	169
1.7	Python IDE	169
1.7.1	Create a New Project.....	170
1.8	Recording.....	171
2.	xArm Motion Analysis.....	174
2.1	Robotic Arm Motion Mode and State Analysis	175
2.1.1	The Motion Mode of the Robotic Arm	175

2.1.2	Analysis of Robotic Arm Movement Mode.....	178
2.1.3	Analysis of the Motion Status of the Robotic Arm.....	180
2.2.	Motion of the Robotic Arm.....	182
2.2.1.	Joint Motion.....	182
2.2.2.	Linear Motion and Arc Linear Motion	187
2.2.3.	Circular and Arc Motion	193
2.3.	xArm5 Motion Characteristics.....	197
2.4.	Singularity.....	198
3.	Typical Examples.....	201
3.1.	The Use of xArm Vacuum Gripper	201
3.2.	The Use of xArm Gripper	202
3.3.	The Use of the Digital IO.....	203
3.4.	Cyclic Motion Count.....	203
Appendix	206
Appendix1	-Error Reporting and Handling.....	206
1.1	Joints Error Message and Error Handling	206
1.2	Control Box Error Code and Error Handling	209
1.2.1	Control Box Error Code	209
1.2.2	Control Box Error Code	211
1.3	Gripper Error Code & Error Handling	211
1.4	Python SDK Error Code & Error Handling	213
Appendix2	-Technical Specifications.....	216

2.1 xArm5/6/7 Common Specifications.....	216
2.2 xArm 5 Specifications.....	217
2.3 xArm 6 Specifications.....	218
2.4 xArm 7 Specifications.....	219
Appendix3-FAQ	221
Appendix4-The xArm Software/Firmware Update Method.....	222
Appendix5- Maintenance and Inspection	232
Appendix6- After-sales Service	233

Preface

Product Information

Package contains:

1. Robotic Arm x 1
2. Control Box x 1
3. Power cable for the Control Box x 1
4. Power cable for the Robotic Arm x 1
5. Communication cable for the Robotic Arm x 1
6. Ethernet Cable x1
7. Robotic Arm end effector adapter cable x1

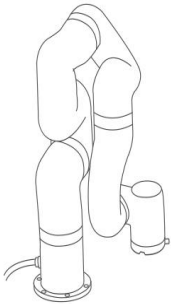

1

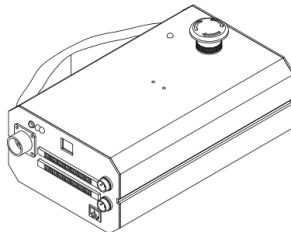

2

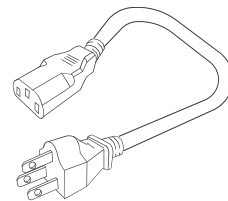

3

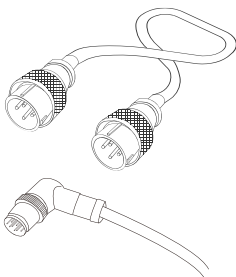

4

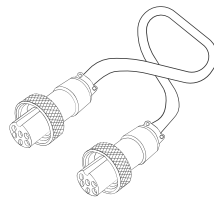

5

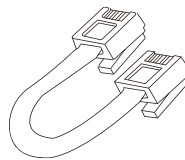

6

7

Main Contents of the Manual

xArm User Manual Hardware Section

- (1) xArm hardware installation
- (2) Electrical interface
- (3) xArm end-effector

xArm User Manual Software Section

- (1) xArm Studio instructions
- (2) xArm motion analysis
- (3) Typical examples

Appendix

- (1) xArm error reporting and handling
- (2) xArm technical specifications
- (3) FAQ
- (4) The xArm software/firmware update method
- (5) Maintenance and Inspection
- (6) After-sales service

Terms and Definitions

The following terms and definitions apply to this manual.

Control Box	The control box, core part of the robotic arm, is the integration of the robotic arm control system.
-------------	--

End Effector	The end effector, installed on the front end of the wrist of the robotic arm, is used to install special tools (such as grippers, vacuum gripper, etc.), which can directly perform work tasks.
Enable Robotic Arm	Power on the robotic arm and turn on the motor of the robotic arm. After the robotic arm is enabled, it can start to move normally.
TCP	Tool center point.
TCP Motion	TCP motion is the Cartesian space motion, with target position in Cartesian space coordinate and the end follows the specified trajectory(arc, line, etc.).
TCP Payload (End Payload)	The payload weight refers to the actual (end tool +other object) weight in Kg; the X / Y / Z-axis indicates the position of the center of mass of the TCP relative to the default tool coordinate system,with unit of mm.
TCP Offset (Tool Center Point Offset)	Set the relative offset between the default tool coordinate system at flange center and the actual tool coordinate system, with distance unit of mm.
Roll/Pitch/Yaw	<p>Roll / Pitch / Yaw sequentially rotates around the X / Y / Z of the selected coordinate system (base coordinate system).</p> <p>The following describes the roll/pitch/yaw orientation representation of {B} relative to {A}:</p> <p>For example, the coordinate system {B} and a known reference coordinate system {A} are first superposed. First rotate {B} around \hat{X}_A by γ, then around \hat{Y}_A by β, and finally around \hat{Z}_A by α.</p> <p>Each rotation is around a fixed axis of the reference coordinate system {A}. This method is called the XYZ fixed angle coordinate system, and sometimes they are defined as the roll angle, pitch angle, and yaw angle.</p> <p>The above description is shown in the following figure:</p> <p>The equivalent rotation matrix is:</p>

	${}^A_B R_{XYZ}(\gamma, \beta, \alpha) = R_Z(\alpha)R_Y(\beta)R_X(\gamma)$ <p>Note: γ corresponds to roll; β corresponds to pitch; α corresponds to yaw.</p>
Axis-Angle	<p>Rx / Ry / Rz representation also, using 3 values to represent the pose (but not three rotation angles), which is the product of a three-dimensional rotation vector [x, y, z] and a rotation angle[phi (scalar)].</p> <p>The characteristics of the axis angle:</p> <p>Assume the rotation axis is [x , y, z], and the rotation angle is phi.</p> <p>Then the representation of the axial angle:</p> $[R_x, R_y, R_z] = [x * \text{phi}, y * \text{phi}, z * \text{phi}]$ <p>Note:</p> <ol style="list-style-type: none"> [x, y, z] is a unit vector, and phi is a non-negative value. The vector length (modulus) of [Rx, Ry, Rz] can be used to estimate the rotation angle, and the vector direction is the rotation direction. If you want to express reverse rotation, invert the rotation axis vector [x, y, z], and the value of phi remains unchanged. Using phi and [x, y, z] can also derive the attitude representation as unit quaternion $q = [\cos(\text{phi} / 2), \sin(\text{phi} / 2) * x, \sin(\text{phi} / 2) * y, \sin(\text{phi} / 2) * z]$. <p>For example:</p> <p>The vector of the rotation axis represented by the base coordinate system is [1, 0, 0], and the rotation angle is 180 degrees (π), then the axis angle representation of this pose is [π, 0, 0].</p> <p>The rotation axis is [0.707, 0.707, 0] and the rotation angle is 90 degrees ($\pi / 2$), then the axis angle posture is [$0.707 * (\pi / 2), 0.707 * (\pi / 2), 0$].</p>
The Base Coordinate System (please refer to the figure 1)	<p>The base coordinate system is a Cartesian coordinate system based on the mounting base of the robotic arm and used to describe the motion of the robotic arm.</p> <p>(front and back: X axis, left and right: Y axis, up and down: Z axis)</p>
Tool Coordinate	<p>Consists of tool center point and coordinate orientation. If the TCP</p>

System (please refer to the figure 1)	offset is not set, the default tool coordinate system is located at flange center. For tool coordinate system based motion: The tool center point is taken as the zero point, and the trajectory of the robotic arm refers to the tool coordinate system.
User Coordinate System (please refer to the figure 1)	The user coordinate system can be defined as any other reference coordinate system rather than the robot base.
Manual Mode	In this mode, the robotic arm will enter the 'zero gravity' mode, since the gravity is compensated, the user can guide the robotic arm position directly by hand.
Teach Sensitivity	Teach sensitivity range is from 1 to 5 level. The larger the set value, the higher the teach sensitivity level, and the less the force required to drag the joint in the manual mode.
Collision Sensitivity	The collision sensitivity range is from 0 to 5 level. When it is set to 0, it means that collision detection is not enabled. The larger the set value, the higher the collision sensitivity level, and the smaller the force required to trigger the collision protection response of the robotic arm.
GPIO	General-purpose input and output. For the input, you can check the potential of the pin by reading a register; For the output, you can write a certain register to make this pin output high or low potential;
Safety Boundary	When this mode is activated, the boundary range of the cartesian space of the robotic arm can be limited. If the tool center point (TCP) exceeds the set safety boundary, the robotic arm will stop
Reduced Mode	When this mode is activated, the maximum linear velocity of the Cartesian motion of the robotic arm, the maximum joint speed, and the range of the joint motion will be limited.

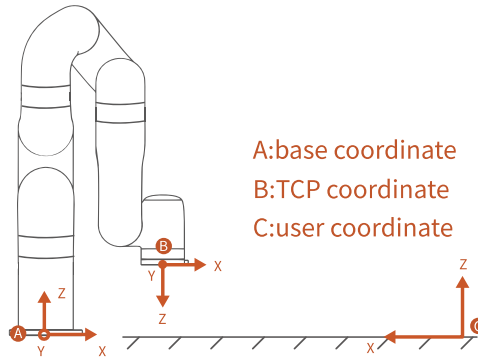

Figure 1

xArm Motion Parameters

The parameters of the robotic arm are shown in Table 1.1 and Table 1.2.

Table 1.1 working range of each joint of the robotic arm

	Robotic Arm	xArm 5	xArm 6	xArm 7
Maximum		180°/s	180°/s	180°/s
Working Range	1st Axis	±360°	±360°	±360°
	2st Axis	-118° ~ 120°	-118° ~ 120°	-118° ~ 120°
	3st Axis	-225° ~ 11°	-225° ~ 11°	±360°
	4st Axis	-97° ~ 180°	±360°	-11° ~ 225°
	5st Axis	±360°	-97° ~ 180°	±360°
	6st Axis	None	±360°	-97° ~ 180°
	7st Axis	None	None	±360°

Table 1.2 range of various motion parameters of the robotic arm

	TCP Motion	Joint Motion
Speed	0 ~ 1000mm/s	0 ~ 180°/s
Acceleration	0 ~ 50000mm/s ²	0 ~ 1145°/s ²
Jerk	0 ~ 10000mm/s ³	0 ~ 28647°/s ³

Note:

1. In the TCP motion (Cartesian space motion) commands (set_position () function of the SDK), If a motion command involves both position transformation and attitude transformation, the attitude rotation speed is generally calculated automatically by the system. In this situation, the specified speed parameter is the maximum linear speed, range from: 0 ~ 1000mm / s.
2. When the expected TCP motion only changes the attitude (roll, pitch, yaw), with position (x, y, z) remains unchanged, the specified speed is the attitude rotation speed, so the range 0 to 1000 corresponds to 0 to 180 ° / s.

Unit Definition

The Python / Blockly examples and the units standard in the communication protocol are shown in Table 1.3.

Table 1.3. Default units in Python / Blockly example and Communication Protocol

Parameter	Python-SDK	Blockly	Communication
X (Y/Z)	millimeter (mm)	millimeter (mm)	millimeter (mm)
Roll (Pitch/Yaw)	degree (°)	degree (°)	radian (rad)
J ₁ (J ₂ /J ₃ /J ₄ /J ₅ /J ₆ /J ₇)	degree (°)	degree (°)	radian (rad)
TCP Speed	mm/s	mm/s	mm/s
TCP Acceleration	mm/s ²	mm/s ²	mm/s ²
TCP Jerk	mm/s ³	mm/s ³	mm/s ³
Joint Speed	°/s	°/s	rad/s
Joint Acceleration	°/s ²	°/s ²	rad/s ²
Joint Jerk	°/s ³	°/s ³	rad/s ³

Additional Information

For xArm Studio software download and xArm developer manual, please refer to the UFACTORY official website.

<https://store-ufactory-cc.myshopify.com/pages/download-xarm>

Safety Precautions

• Introduction

This chapter contains essential safety information, integrators and users of xArm must follow the instructions and pay special attention to the content with warning signs. Due to the complexity of the robotic arm system and its degree of danger, please ensure you fully understand the content of this manual and strictly adhere to the instructions. When using SDK (Python/ROS/C++) and graphical interface (xArm Studio), please read the relevant interface instructions demonstrated in this operation manual.

UFACTORY devotes to providing reliable and safety information, but these contents do not constitute warranties by UFACTORY. UFACTORY will not have or accept any liability, obligation, or responsibility whatsoever for any loss, destruction, or damage arising from or in respect of any use or misuse of xArm.

• **Validity and Responsibility**

The information does not cover how to design, install, and operate a complete robotic arm application, nor does it cover all peripheral equipment that can influence the safety of the complete system. The complete system must be designed and installed under the safety requirements outlined in the standards and regulations of the country where the robotic arm installed.

The integrators of the xArm are responsible for the compliance of applicable safety laws and regulations in the country, to prevent any hazards in the operating environment.

Safety precautions include but are not limited to:





- Making a risk assessment for the complete system. Make sure to have a safe distance between people and xArm when interacting with the xArm.
- Interfacing other machines and additional safety devices if defined by the risk assessment.
- For software programming, please read the interface documentations carefully and set up the appropriate safety functions in the software.
- Specifying instructions for use to prevent unnecessary property

damage or personal injury caused by improper operation.

- **Limitations on Liability Exceptions**

Any information given in this manual regarding safety must not be construed as a warranty by UFACTORY that the xArm will not cause injury or damage even if all safety instructions are complied with.

- **Safety Alarms in this Manual**

 <p>DANGER</p>	<p>DANGER:</p> <p>This indicates an imminently hazardous electrical situation, which if not avoided, could result in death or serious damage to the device.</p>
 <p>WARNING</p>	<p>WARNING:</p> <p>This indicates a potentially hazardous situation which, if not avoided, could result in death or serious damage to the device.</p>
 <p>HIGH TEMPERATURE</p>	<p>HIGH TEMPERATURE</p> <p>This indicates a potential hot surface, which if touched, could result in personal injury.</p>
 <p>NOTICE</p>	<p>NOTICE</p> <p>If not avoided, could result in personal injury or damage to the equipment.</p>



CAUTION

CAUTION:

If not avoided, could result in personal injury or damage to the equipment.

- **Safety Precautions**

Overview

This section contains some general warnings and cautions on installation and application planning for the robotic arm. To prevent damage to the machine and associated equipment, users need to learn all the relevant content and fully understand the safety precautions. We do not control or guarantee the relevance or completeness of such information in this manual, for which users should conduct self-assessment of their specific problems.

General Alarms and Cautions



DANGER

1. Make sure to use the correct installation settings in this manual for the robotic arm and all the electrical equipment.
2. Please follow the instructions in this manual, installation, and commissioning needs to be performed by professionals in accordance with the installation standards.

3. Make sure the robotic arm and tool are properly and securely bolted in place.
4. The integrity of the device and system must be checked before each use (e.g. the operational safety and the possible damage of the robotic arm and other device systems).
5. Preliminary testing and inspection for both robotic arm and peripheral protection system before production is essential.
6. The operator must be trained to guarantee a correct operation procedure when using SDK(Python/ROS/C++) and graphical interface xArm Studio.
7. A complete safety assessment must be recorded each time the robotic arm is re-installed and debugged.
8. When the robotic arm is in an accident or abnormal operation, the emergency stop switch needs to be pressed down to stop the movement, and the posture of the robotic arm will slightly brake and fall.
9. The xArm joint module has brakes inside, which will remain manipulator's pose when a power outage occurs.
10. When the robotic arm is in operation, make sure no people or other equipment are in the working area.

11. When releasing the brakes of xArm, please take protective measures to prevent the robotic arm or operator from damage or injury.
12. When connecting the xArm with other machinery, it may increase risk and result in dangerous consequences. Make sure a consistent and complete safety assessment is conducted for the installation system.



HIGH TEMPERATURE

1. The robotic arm and Control Box will generate heat during operation. Do not handle or touch the robotic arm and Control Box while in operation or immediately after the operation.
2. Never stick fingers to the connector of the end-effector.



CAUTION

1. Make sure the robotic arm's joints and tools are installed properly and safely, and check the status for all circuits.
2. Make sure that there is enough space for the manipulator to move freely.
3. Make sure that there is no obstacle in the robotic arm's working space.
4. The Control Box must be placed outside the working range of the robotic arm to ensure the emergency stop button can be pressed once an emergency occurs.
5. If the robotic arm is in operation and needs an emergency stop, make sure the restart/reset

motions will not collide with any obstacle.

6. Do not modify the robotic arm(or Control Box). Any modification may lead to unpredictable danger to the integrators. The authorized restructuring needs to be in accordance with the latest version of all relevant service manuals. If the robotic arm is modified or altered in any way, UFACTORY (Shenzhen) Technology Co., Ltd. disclaims all liability.
7. Users need to check the collision protection and water-proof measures before any transportation.



NOTICE

When the xArm cooperates with other machinery, a comprehensive safety assessment of the entire collaboration system should be performed. It is recommended that any equipment that may cause mechanical damage to xArm be placed outside the working range during application planning.

Operator Safety

In the operation of the robotic arm system, we must ensure the safety of the operators first, with the general precautions listed in the table below. Please take appropriate measures to ensure the safety of operators.



CAUTION

1. Each operator who uses the robotic arm system should read the product user manual carefully. Users should fully understand the standardized operating procedures with the robotic arm, and the solution to the robotic arm running error.
2. When the device is running, even if the robotic arm seems to stop, the robotic arm may be waiting for the signal and in the upcoming action status. Even in such a state, it should be considered as the robotic arm is in action.
3. A line should be drawn to mark the range of motion of the robotic arm to let the operator acknowledge the robotic arm, including its end tools (such as gripper and suction cup, etc) operating range.
4. Check the robotic arm regularly to prevent loosening of the bolts that may cause undesirable consequences.
5. Be careful when the robotic arm is running too fast.
6. Be careful about dropping items that can be caused by accidental power off or unstable clamping of the robotic arm.

xArm User Manual-Hardware Section

1. Hardware Installation Manual

1.1.The Hardware Composition of xArm

1.1.1. Hardware Composition

The composition of robotic arm hardware includes:

- Robotic Arm (Figure 2-1)
- Control Box (Figure 2-2)
- Robotic Arm Signal Cable (Figure 2-3)
- Robotic Arm Power Supply Cable (Figure 2-4)
- Control Box Power Supply Cable (Figure 2-5)

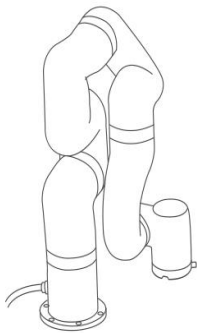

Figure 2-1

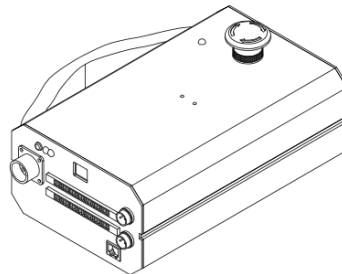

Figure 2-2

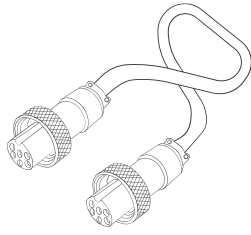

Figure 2-3

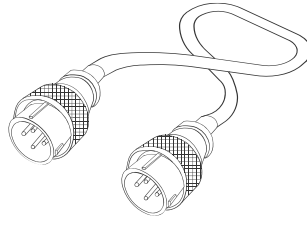

Figure 2-4

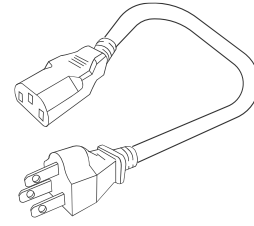

Figure 2-5

The xArm robotic arm system consists of a base and rotary joints, and each joint represents a degree of freedom. From the bottom to the top, in order, Joint 1, Joint 2, Joint 3, etc. The last joint is known as the tool side and can be used to connect end-effector (e.g. gripper, vacuum gripper, etc).

Refer to technical specifications for joint Figures (See appendix-2) .

1.1.2. Emergency Stop Button

By pressing the emergency stop button of the Control Box, a command will be sent to the Control Box for software deceleration to stop all activities of the robotic arm and clear all the cached commands in the Control Box; the power supply for the robotic arm will be removed within 300ms. The emergency stop should not be used as a risk reduction measure. When an emergency occurs during the operation of the robotic arm, users need to press the emergency stop, and the posture of the robotic arm will slightly brake and fall. The emergency

stop button is shown below:

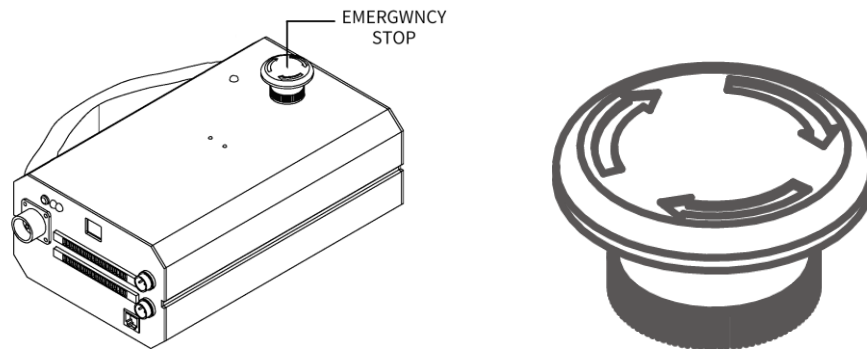

Emergency Stop: press the emergency stop button to power off the xArm, and the power indicator will go out.

Power-on: when the button is rotated in the direction indicated by the arrow, the button is pulled up, the xArm power indicator lights up, and the arm is powered.

Note:

After pressing the emergency stop button, the following operations should be performed to re-start the xArm:

1. Power up the xArm (Turn the emergency stop button in the direction of the arrow)
2. Enable the xArm (enable the servo motor)

xArm Studio: enable the robotic arm:click the button: [Enable Robot]

Python-SDK: enable the robotic arm: `motion_enable (true)`

1.1.3. Control Box Description

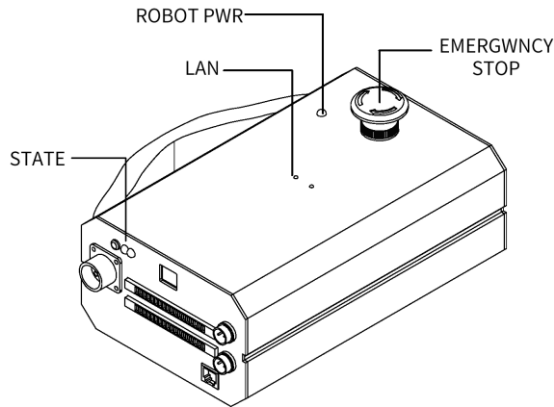

Control Box Buttons and	Parameter Name	Function
ROBOT power indicator	ROBOT PWR	The light is on, indicating that the xArm is powered on.
Control Box power status indicator	STATE	The light flashes, indicating that the control box is powered on.
Network port indicator	LAN	The light is on, indicating that the xArm is communicating normally.
Emergency stop button	EMERGENCY STOP	Press the button to power off the xArm; Rotate the button, the ROBOT power

1.2. Robot Installation

1.2.1. Safety Guidelines for the Robot Environment



DANGER

1. Make sure the arm is properly and safely installed in place. The mounting surface must be shockproof and sturdy.
2. To install the arm body, check that the bolts are

tight.

3. The robotic arm should be installed on a sturdy surface that is sufficient to withstand at least 10 times the full torsion of the base joint and at least 5 times the weight of the arm.



WARNING

1. The robotic arm and its hardware composition must not be in direct contact with the liquid, and should not be placed in a humid environment for a long time.
2. A safety assessment is required each time installed.
3. When connecting or disconnecting the arm cable, make sure that the external AC is disconnected. To avoid any electric shock hazard, do not connect or disconnect the robotic arm cable when the robotic arm is connecting with external AC.

1.2.2. Robot Installation

1. Brief installation steps:
 - a. Define a robotic arm workspace
 - b. Fix the robotic arm base
 - c. Connect the robotic arm with the Control Box
 - d. Connect the Control Box with cable
 - e. Install end-effector

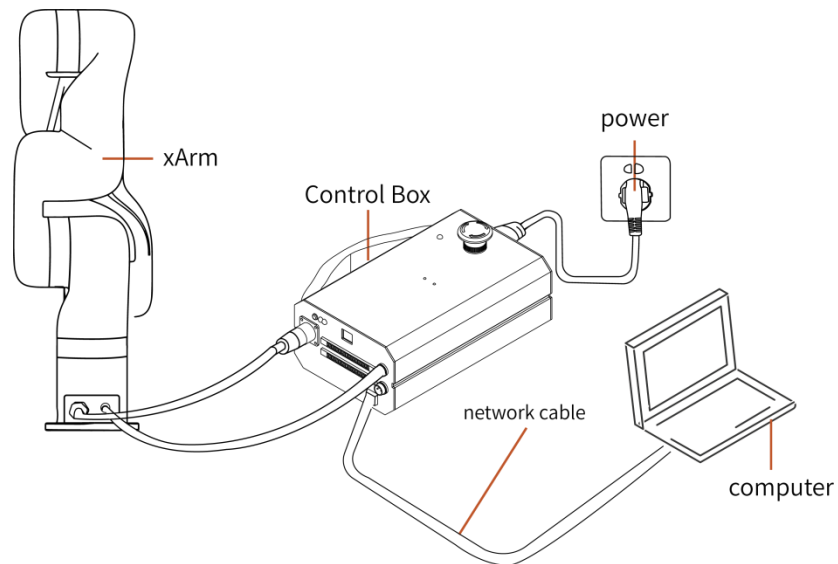

1.2.2.1. Define a Robotic Arm Workspace

The robotic arm workspace refers to the area within the extension of the links. The figure below shows the dimensions and working range of the robotic arm. When installing the robotic arm, make sure the range of motion of the robotic arm is taken into account, so as not to bump into the surrounding people and equipment (the end-effector not included in the working range).

Working space of xArm7 (unit: mm)

Note : The following working range diagrams are only for safety assessment.

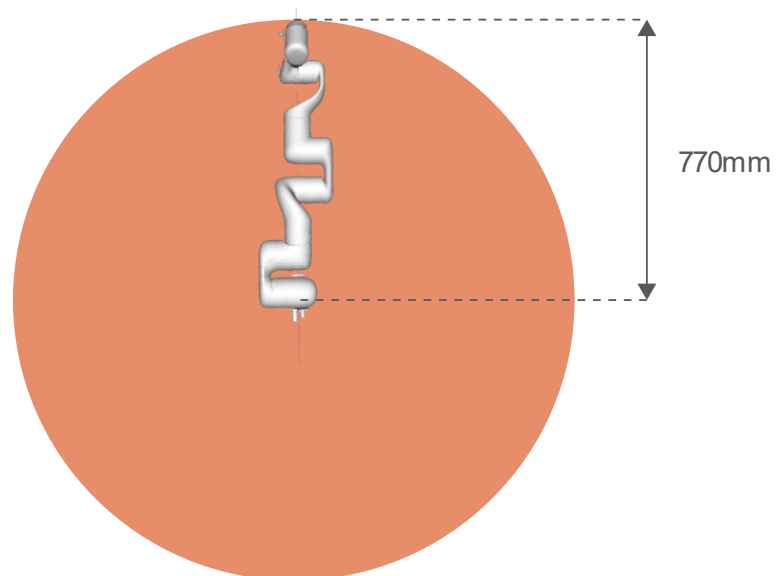
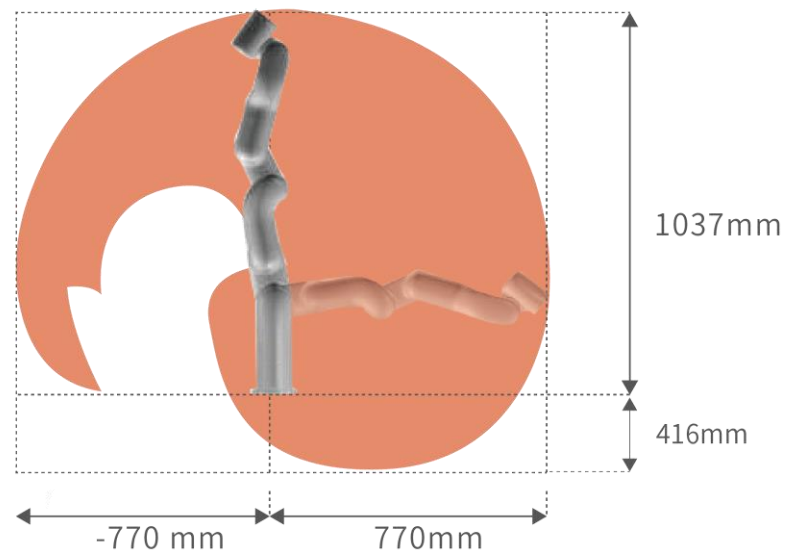

Working space of xArm5 and xArm6 (unit: mm)

Note : The following working range diagrams are only for safety assessment.

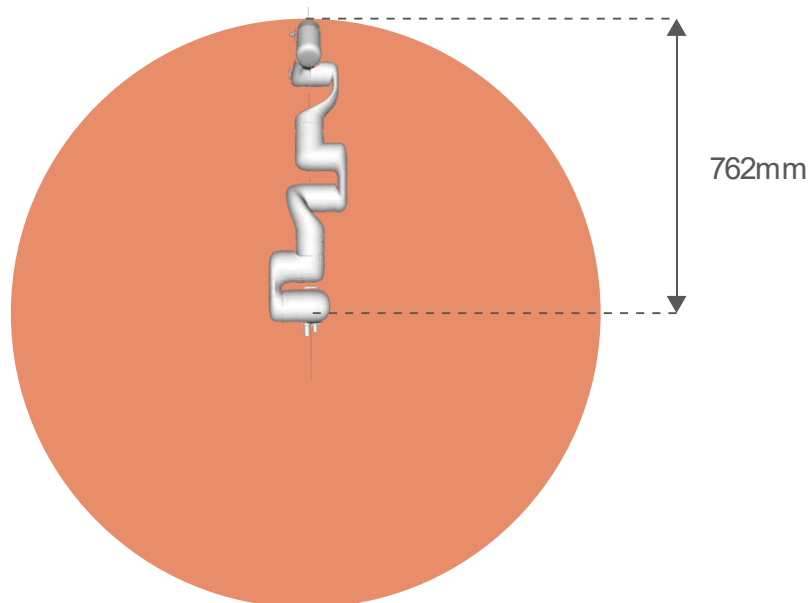
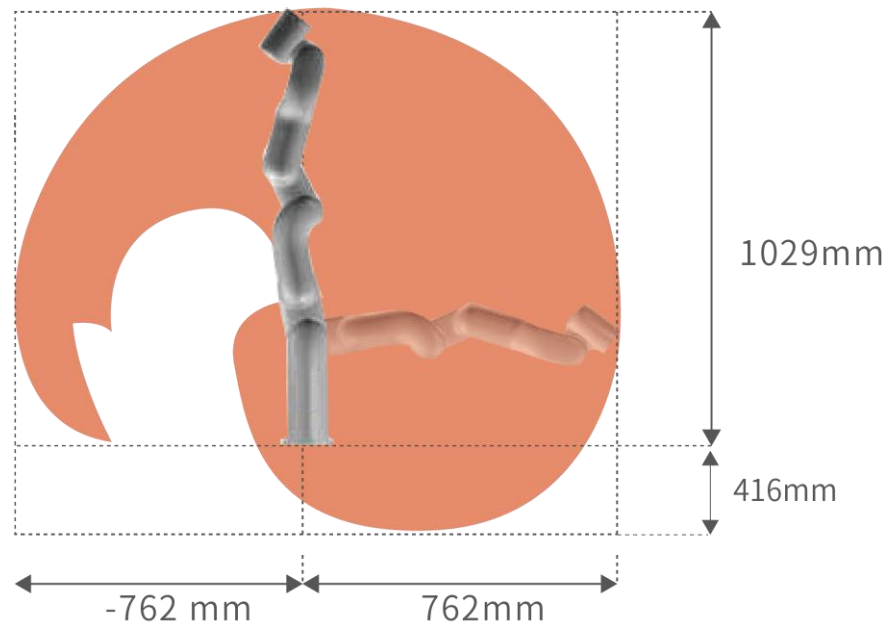

1.2.2.2. Robot Installation

The robotic arm has five M5 bolts provided and can be mounted through five $\varnothing 5.5$ holes in the base of the robotic arm. It is recommended to tighten these bolts with a torque of 20N·m.

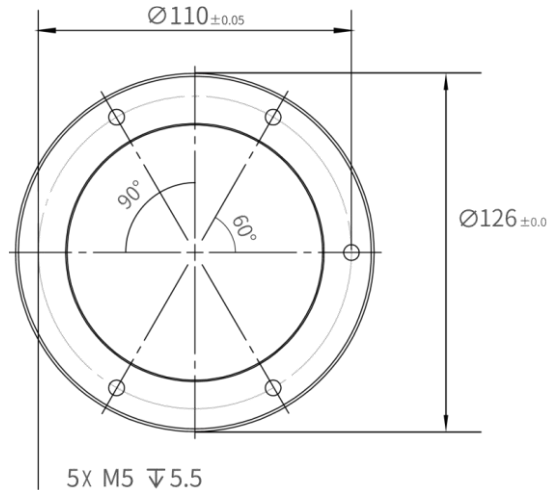

Robot Base Mounting (unit: mm)

1.2.2.3. Robotic Arm is Connected to the Control Box

Plug the connector of the Robotic Arm Power Supply Cable and the Robotic Arm Signal Cable into the interface of the Robotic Arm. The connector is a foolproof design. Please do not unplug and plug it violently;

Plug the Robotic Arm Power Supply Cable and the Robotic Arm Signal Cable into the Control Box;

Plug the Control Box Power Cable into the AC (110V-240V) interface on the Control Box and the other end into the socket (as shown in Figure

below).

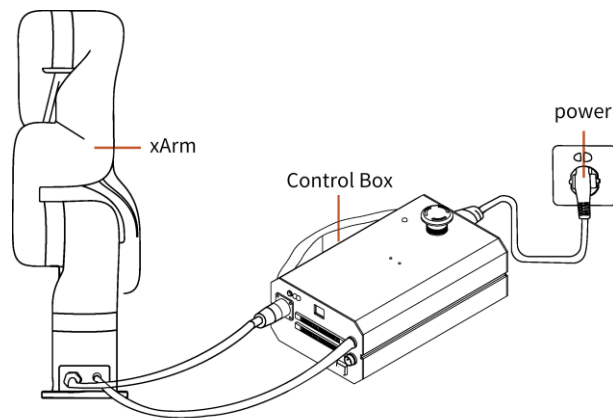

1.2.2.4. Control Box Networking

Plug the Network Cable into the interface marked LAN on the Control Box, and plug the other end of the Network Cable into the computer.

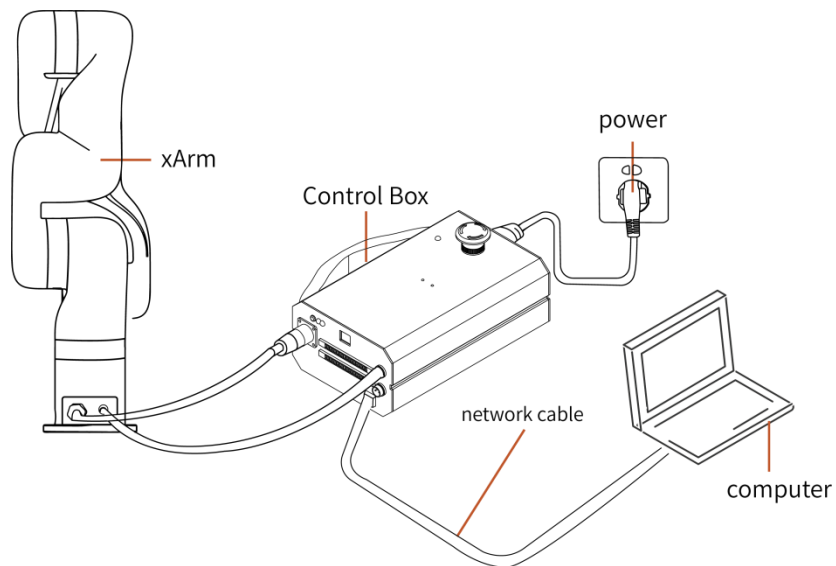

1.2.2.5. End-effector Installation

The End-effector flange has fourteen M6 threaded holes and one $\Phi 5$ positioning hole, where the end-effector of two different sizes can be mounted. If the effector does not have a positioning hole, the

orientation of the end-effector must be documented in a file format, to avoid errors and unexpected results when re-installing the end-effector.

The end-effector flange referenced the DIN ISO 9409-1-A50/A63 standard.

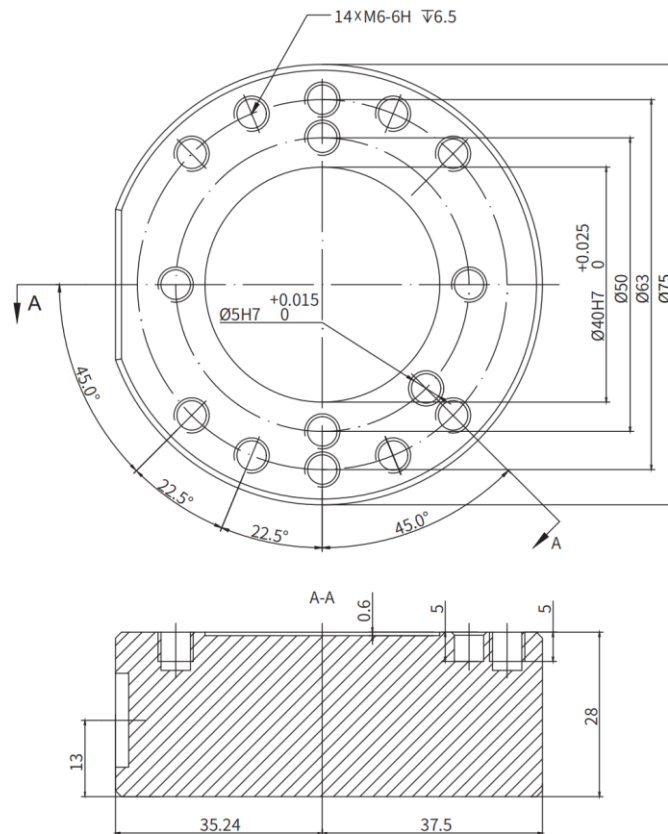

Mechanical dimensions of end-effector flange (unit: mm)

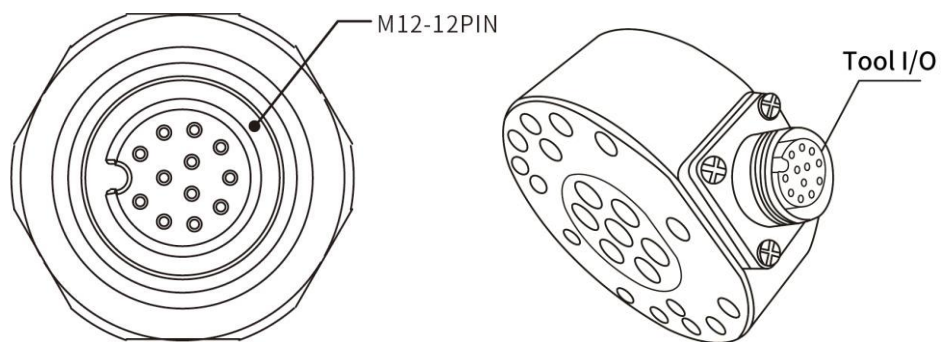

Drawing of tool I/O



DANGER

1. Make sure the tool is properly and safely bolted in place.
2. If the end-effector does not have a locating hole, the orientation of the end-effector must be archived as a file.
3. Make sure that the tool is safely constructed such that it cannot create a hazardous situation by dropping a part unexpectedly.
4. Pay attention to the operation specifications of sharp end-effector tools.
5. If the installed end-effector exceeds the robotic arm mounting surface at the zero position of the robotic arm, a safety assessment is required for the zero return operation.

1.3. Power Supply for the Robotic Arm

1.3.1. Preparation before Power On

- Ensure the power cable and the communication wire are properly connected between the Control Box and the robotic arm.
- Ensure the network cable or RS-485 cable is properly connected.
- Ensure the power cable for the Control Box is properly connected.
- Ensure the xArm will not hit any personnel or equipment within

the working range.

1.3.2. Power On

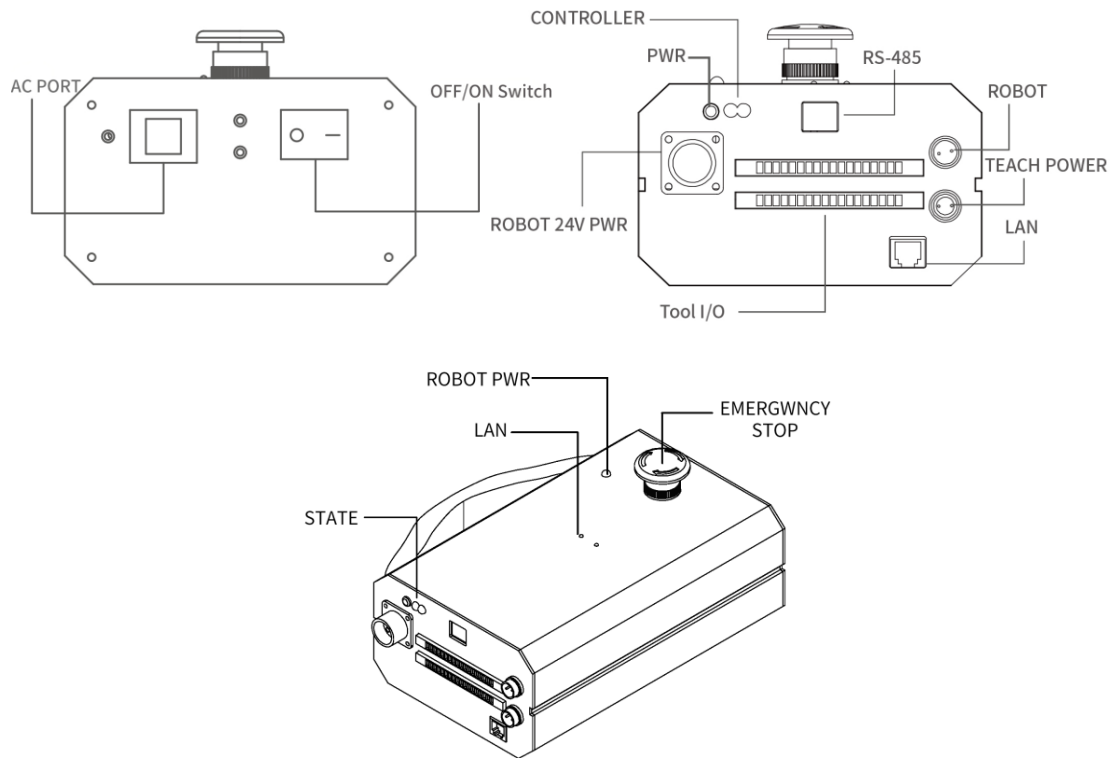

1. Turn on the OFF/ON button and ensure the indicator lights are lit.
2. Press the power button, when the status indicator (CONTROLLER) lights up, the control box is turned on.
3. Rotate the emergency stop button in the direction indicated by the arrow and is pulled up, at which point the xArm power indicator (ROBOT PWR) lights up.
4. Use the xArm Studio / SDK command to complete the operation of enabling the robotic arm. (enable the servo motor)

1.3.3. Shut Down the Robotic Arm System

1. Shutdown Sequence

- (1) Press the EMERGENCY STOP button to power off the robotic arm.
- (2) Ensure the power indicator light is off.

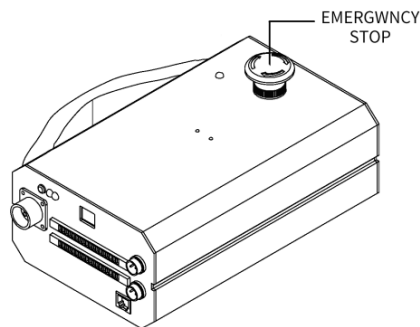

2. Shutdown the control box

- (1) Press the power button (PWR) of the control box for about 5s to turn off the status light.
- (2) Turn off the power supply of the control box. (the power switch takes about 5 seconds to turn off the power of the control box.

If users like to restart the power right after turning off the power supply, they need to press the power button manually.)

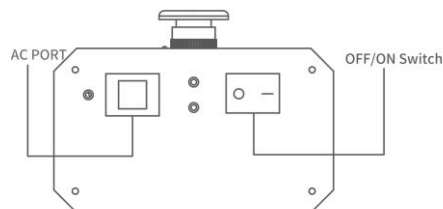



WARNING

Unplugging the power cord directly from the wall outlet to shut down the system may result in damage to the file system of the control box, which may result in robotic arm malfunction.

2. Electrical Interface

2.1.AC Control Box

2.1.1. Connect the Control Box to the Robotic Arm

1. The robotic arm power supply cable connects the power port of the robotic arm and the ROBOT power port of the control box.
2. The robotic arm signal cable is connected to the signal interface of the robotic arm and the ROBOT signal interface of the control box.

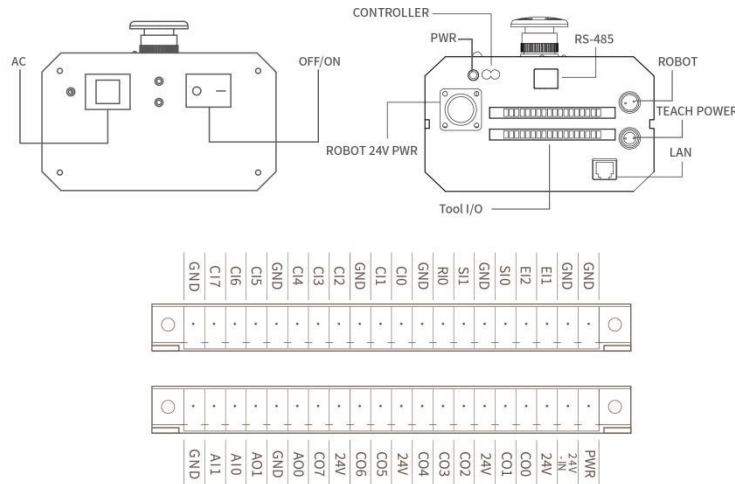

2.1.2. Power Connection

There is a standard IEC plug at the end of the control box's main cable.

Connect a local dedicated main outlet or cable to the IEC plug. The

control box is powered by 110V-240V AC (the input frequency is 50-60HZ) and its internal switching power supply converts 110V-240V AC into 12V, 24V DC, which supplies power to the load of the control box and the robotic arm.

Therefore, it is necessary to check whether the connection between the robotic arm and the control box is secured before use. The hardware protection and software protection of the control box can ensure the safety of use largely. The emergency stop button of the control box allows the user to cut off the power of the robotic arm in the shortest time possible and protect the safety of both personnel and the equipment.

To power on the robotic arm, the control box must be connected to the power supply. In this process, the corresponding IEC C19 wire must be used.

Connect to the standard IEC C20 plug of the Control Box to complete the process, see the figure below.

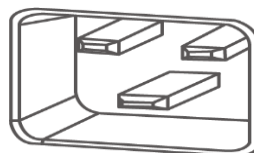

2.1.3. Definition of the Robotic Arm Industrial

Connector

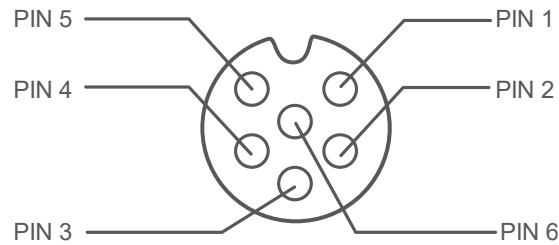

6-Pin Industrial Connector (Robot Communication)	
Industrial connector wire sequence	Functional definition
1	GND
2	485-A Arm
3	485-B Arm
4	GND
5	485-A Tool
6	485-B Tool

2.2. DC Control Box

2.2.1. External Interfaces of Control Box

Except that the DC Control Box is connected to different power sources, the other electrical interface specifications and functions are the same as the AC Control Box.

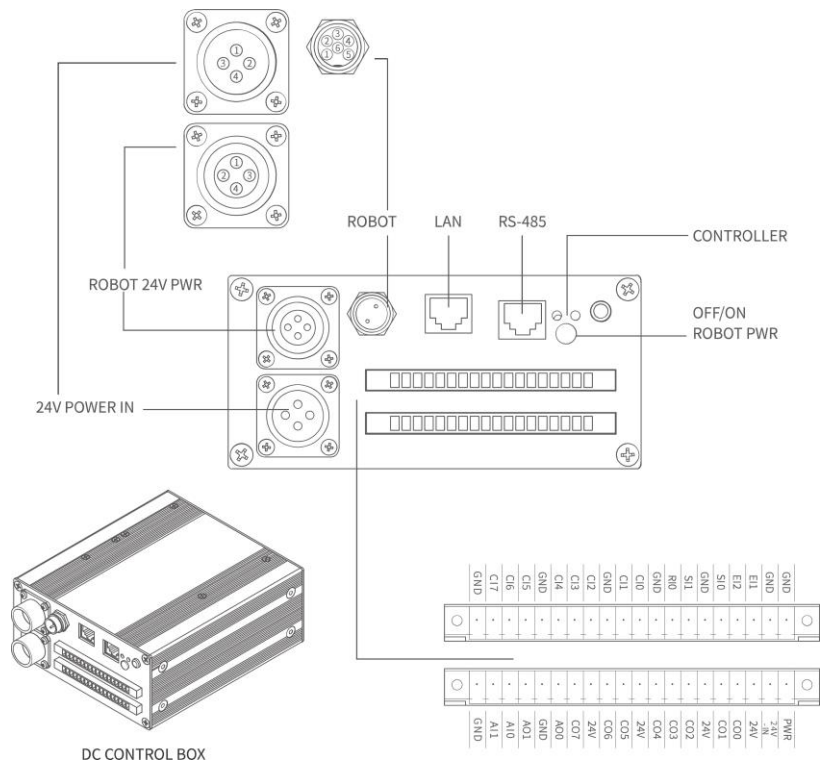

2.2.2. Definition of Industrial Connector

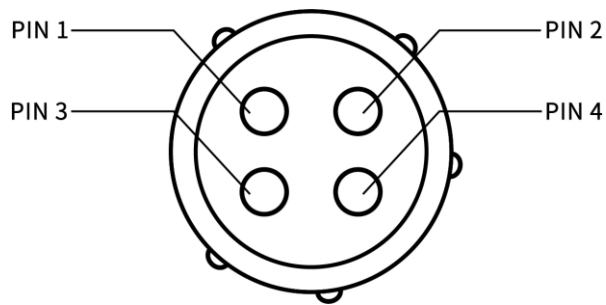



4-Pin Industrial Connector (External 24V Power)	
Industrial connector wire sequence	Functional definition
1	24V
2	GND
3	Null
4	Null



2.2.3. Specification of External Power

Input	
Rated voltage	24V-28V
Rated power	400W
Rated current	17A

2.2.4. Electrical Alarms and Cautions

Always follow the warnings and cautions below when designing and installing a robotic arm application. These warnings and cautions are also subject to the implementation of maintenance work.

 DANGER	<ol style="list-style-type: none">1. Never connect a safety signal to a non-safety PLC. Failure to follow this warning may result in serious injury or death due to an invalid safety stop function.
 NOTICE	<ol style="list-style-type: none">1. Make sure that all the non-waterproof equipment is kept dry. If water enters the product, turn off the power supply, and contact your supplier.2. Use only the original cable of the robotic arm. Do not use the robotic arm in applications where the cable needs to be bent. If you need a longer cable or flexible cable, please contact your supplier.3. All GND connectors mentioned in this manual are only suitable for powering and transmitting signals.4. Be careful when installing the interface cable to

	the I/O of the robotic arm.
 <p>CAUTION</p>	<ol style="list-style-type: none"> 1. Interfering signals above the level specified in the IEC standard will cause abnormal behaviour of the robotic arm. Extremely high signal levels or excessive exposure can cause permanent damage to the robotic arm. UFACTORY (Shenzhen) Technology Co., Ltd. is not responsible for any loss caused by EMC problems. 2. The length of the I/O cable that used to connect the Control Box with other mechanical and plant equipment must not exceed 30 meters unless it is feasible after the extension testing.
 <p>WARNING</p>	<ol style="list-style-type: none"> 1. When wiring the electrical interface of the Control Box, the Control Box must be powered off.

2.3. End-Effector I/O

At the tool side of the robotic arm, there is an avionic socket 12-pin female industrial connector. This connector provides power and control signals for the grippers and sensors used on a particular robotic arm tool. Please refer to the figure below:

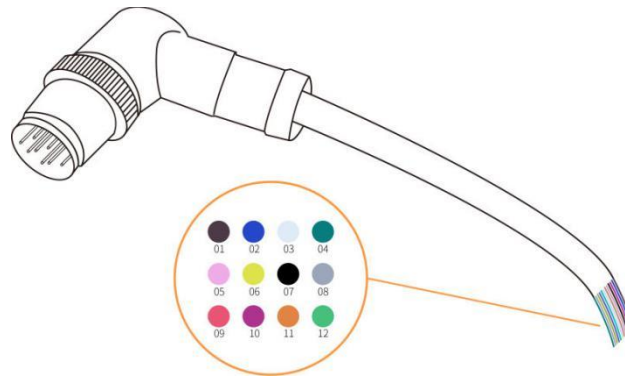
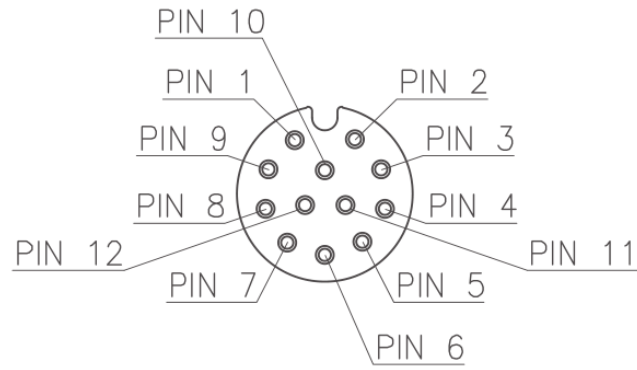

There are 12 pins inside the cable with different colors, each color represents different functions, please refer to the following table:

Pin sequence	Color	Signal
1	Brown	+24V (Power)
2	Blue	+24V (Power)
3	White	0V (GND)
4	Green	0V (GND)
5	Pink	User 485-A
6	Yellow	User 485-B
7	Black	Tool Output 0 (TO0)
8	Grey	Tool Output 1 (TO1)
9	Red	Tool Input 0 (TI0)
10	Purple	Tool Input 1 (TI1)
11	Orange	Analog input 0 (AI0)
12	Light Green	Analog input 1 (AI1)

The electrical specifications are as follows:

Parameter	Min. Value	Typical Value	Max. Value	Unit
Supply Voltage in 24V	-	24	30	V
Supply Current *	-	-	1800	mA

Note: * It is strongly recommended to use a protection diode for inductive loads.



DANGER

Make sure that the connecting tool and the gripper do not cause any danger when the power is cut, such as dropping of the work-piece from the tool.

2.3.1. Digital Output

The digital output is implemented in the form of NPN with an open collector(OC). When the digital output is activated, the corresponding connector will be driven to GND. When the digital output is disabled, the corresponding connector will be open (open collector/open drain).

The electrical specifications are as follows:

Parameter	Min	Typical	Max	Unit
Open-circuit Voltage	-0.5	-	30	V
Voltage when sinking 50mA	-	0.05	0.20	V
Sink Current	0	-	50	mA
Current through GND	0	-	50	mA

There is no current protection on the digital output of the tool, which can cause permanent damage if the specified value exceeded.



CAUTION

2.3.1.1. Tool Digital Output Usage

The following example illustrates how to use the digital output. As the internal output is an open collector, the resistor should be connected to the power supply according to the load. The size and power of the resistor depend on the specific use.

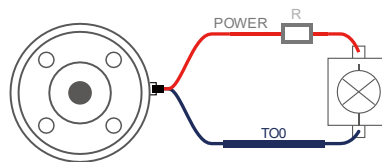

Note: It is highly recommended to use a protection diode for inductive loads as shown below.

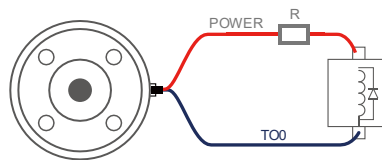

2.3.2. Digital Input

The digital input is already equipped with a pull-down resistor. This means that the reading of the floating input is always low. The electrical specifications are as follows:

Parameter	Min	Typical	Max	Unit
Input Voltage	-0.5	-	30	V

Logic Low Voltage	-	-	1.0	V
Logic High Voltage	1.6	-	-	V
Input Resistance	-	47k	-	Ω

2.3.2.1. Tool Digital Input Usage

The following figure shows the connection with the simple switch.

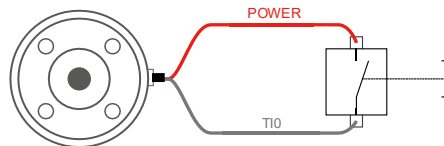

2.3.3. Tool Analog Input

The tool analog input is a non-differential input. The electrical specifications are as follows:

Parameter	Min	Typical	Max	Unit
Input Voltage in Voltage Mode	-0.5	-	3.3	V
Resolution	-	12	-	Bit
Input Current in Current Mode	-	-	-	mA
Pull-down Resistors in the 4mA to 20mA	-	-	165	Ω
Resolution	-	12	-	Bit



CAUTION

1. In the current/voltage mode, the analog input does not provide over-voltage protection. Exceeding the limits in the electrical code may result in permanent damage to the input port.
2. In current mode, the pull-down resistance depends on the range of the input current.

2.3.3.1. Non-differential Analog Input

The following figures show how the analog sensor can be connected to a non-differential output.

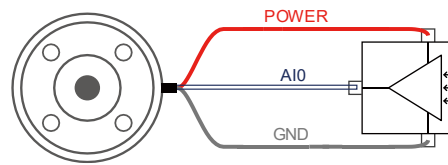

Voltage mode

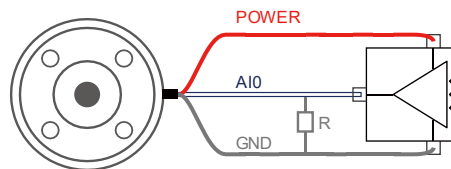

Current mode

2.3.3.2. Differential Analog Input

The following figures show how the analog sensor is connected to the differential output. Connect the negative output to GND (0V), and it can work like a non-differential sensor.

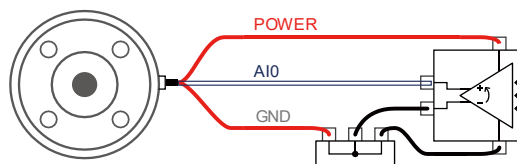

Voltage Mode

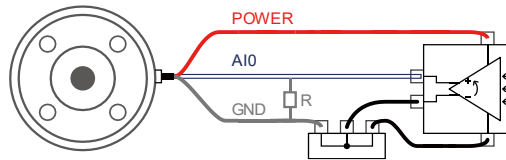

Current Mode

2.4. Control Box Electrical IO

This chapter explains how to connect devices to the electrical I/O outside of the control box.

The I/Os are extremely flexible and can be used in many different devices, including pneumatic relays, PLCs, and emergency stop buttons.

The figure below shows the electrical interface layout inside the control box.

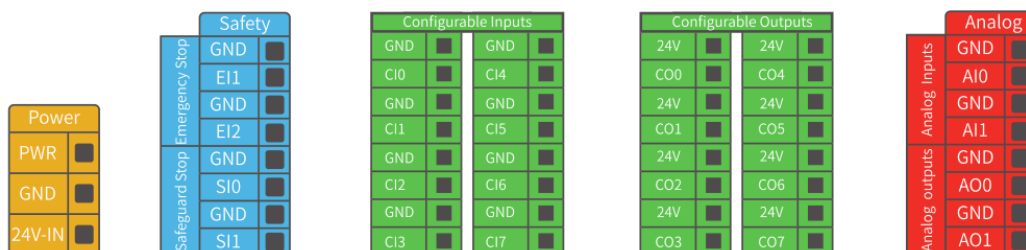

2.4.1. General Specifications for all Digital I/O

This section describes the electrical specifications for the following 24V digital I/Os for the Control Box.

- Dedicated safety I/O.
- Configurable common I/O.

It is very important to install xArm according to the electrical specifications.

All the I/O must comply with the specifications. The digital I/O can be powered by a internal 24V power supply or by an external power supply by configuring the power junction box. In the following figure, PWR is the internal 24V power output. The lower terminal (24V-IN) is the 24V input external power input for I/O. The default configuration is to use internal power, see below.

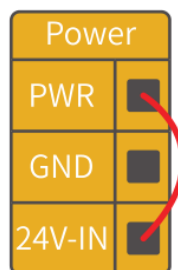

If larger current is needed, connect the external power supply as shown below.

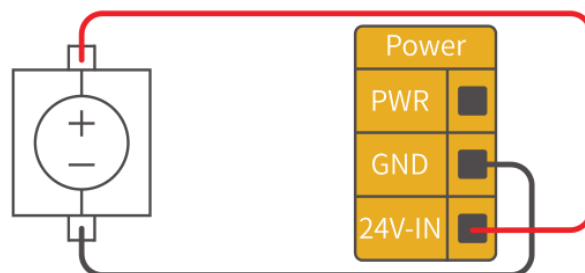

The electrical specifications for the internal and external power supplies

are as follows.

Terminal	Parameter	Min. Value	Typical Value	Max. Value	Unit
Built-in 24V Power Supply					
[PWR -	Voltage	23	24	30	V
[PWR -	Current	0	-	1.8	A
External 24V Input Requirement					
[24V - 0V]	Voltage	20	24	30	V
[24V - 0V]	Current	0	-	5	A

The digital I/O electrical specifications are as follows.

Terminal	Parameter	Min. Value	Typical Value	Max. Value	Unit
Digital Output					
[COx]	Current*	0	-	50	mA
[COx]	Voltage Goes	0	-	0.5	V
[COx]	Open Drain	0	-	0.1	mA
[COx]	Function	-	NPN (OC)	-	Type
Digital Input					
[Elx/Slx/Clx/Rlx]	Voltage	0	-	30	V
[Elx/Slx/Clx/Rlx]	OFF Area	0.7	-	30	V
[Elx/Slx/Clx/Rlx]	ON Area	0	-	0.5	V
[Elx/Slx/Clx/Rlx]	Current (0-0.5)	0.5	-	0.7	mA
[Elx/Slx/Clx/Rlx]	Function	-	-	-	Type
Note: ** For resistive or inductive loads up to 1H.					



CAUTION

There is no current protection on the digital output of the Control Box. If the specified values exceeded, permanent damage may result.

2.4.2. Dedicated Safety I/O

This section describes the dedicated safety inputs and their configurations of the safety I/O. Please follow the universal specifications in Section 2.4.1.

Safety devices and equipment must be installed to comply with the safety instructions and risk assessment (see Chapter 1).

All safety I/Os exist in pairs (redundancy) and must be kept in two separate branches. A single I/O failure should not result in the loss of safety features. There are two fixed safety inputs:

- The robotic arm emergency stop input is only used for the emergency stop of the device.
- The protective stop input is used for all types of safety protection.

The functional differences are as follows.

	Emergency Stop	Protective Stop
Stops the motion of the robotic	Yes	Yes
Program execution	Stop	Suspend
The power supply of the robotic	Off	On
Reset	Manual	Auto or manual
Usage frequency	Not frequent	No more than once per run
Need re-initiation	Only releasing the brake	No

2.4.2.1. Default Safety Configuration

The robotic arm has been configured by default and can be operated without any additional safety equipment, as the figure below. If there is a problem with the robotic arm, please check the following figure for the correct connection.



2.4.2.2. Connect to the Emergency Stop Button

In most applications, one or more additional emergency stop buttons are required. The figure below shows how to connect one or more emergency stop buttons.

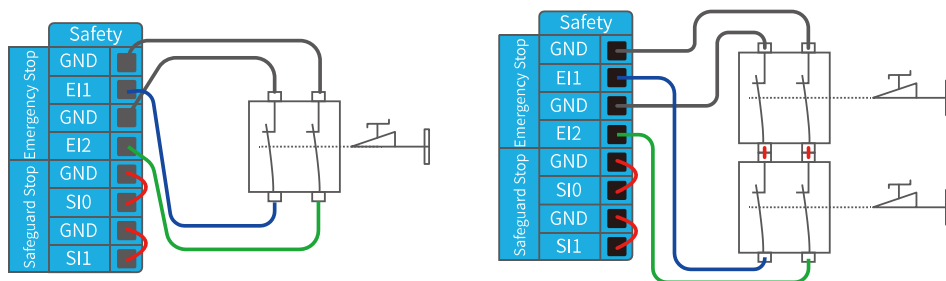

2.4.2.3. Share Emergency Stop with other Machines

When a robotic arm is used with other machines, it requires to set up a common emergency stop circuit in most of the time. The following figure shows that two robotic arms share an emergency stop button (the connection method shown in the figure below also applies to multiple robotic arms sharing an emergency stop button).

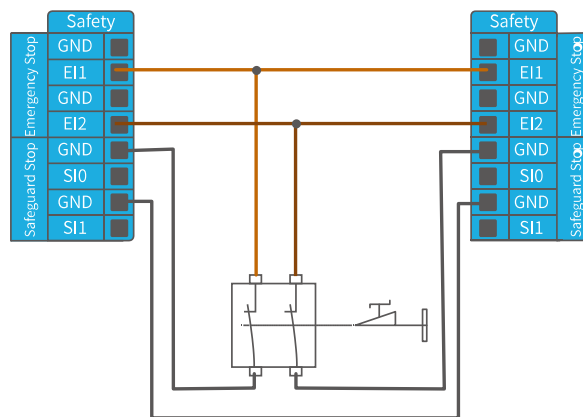

2.4.2.4. Automatically Recoverable Protective Stop

The door switch is an example of a basic protective stop device. When the door is open, the robotic arm stops. See the figure below.

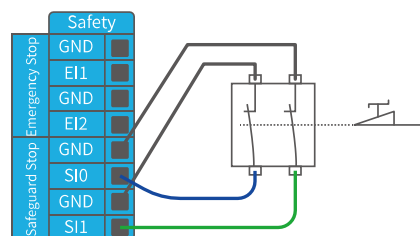

This configuration is only for applications where the operator is unable to close the door from behind. Configurable I/O can be used to set the

reset button outside the door, as to reactivate the movement of the robotic arm. Another example of an automatic recovery is the use of a safety pad or a safety laser scanner, see the figure below.

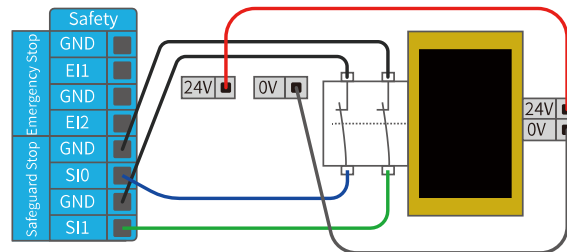

2.4.2.5. Protective Stop with Reset Button

If you use a protective interface to interact with the light curtain, you need to reset from outside the safety zone. The reset button must be a two-channel button. In the example shown below, the I/O of the reset configuration is "CI0-CI1" .(the corresponding configuration must also be done in xArmStudio)

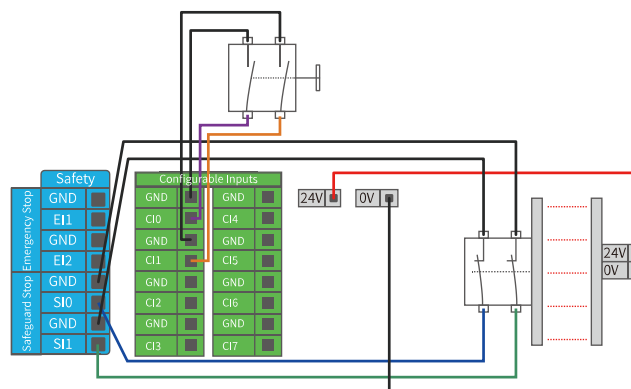

How to realize the protection reset function with reset button:

1. Configure "CI0-CI1" as the protection reset in xArm Studio. The specific steps are as follows:

Enter "Settings" - "I/O" - "Input" - Configure CI0 and CI1 as protection reset - "Save".

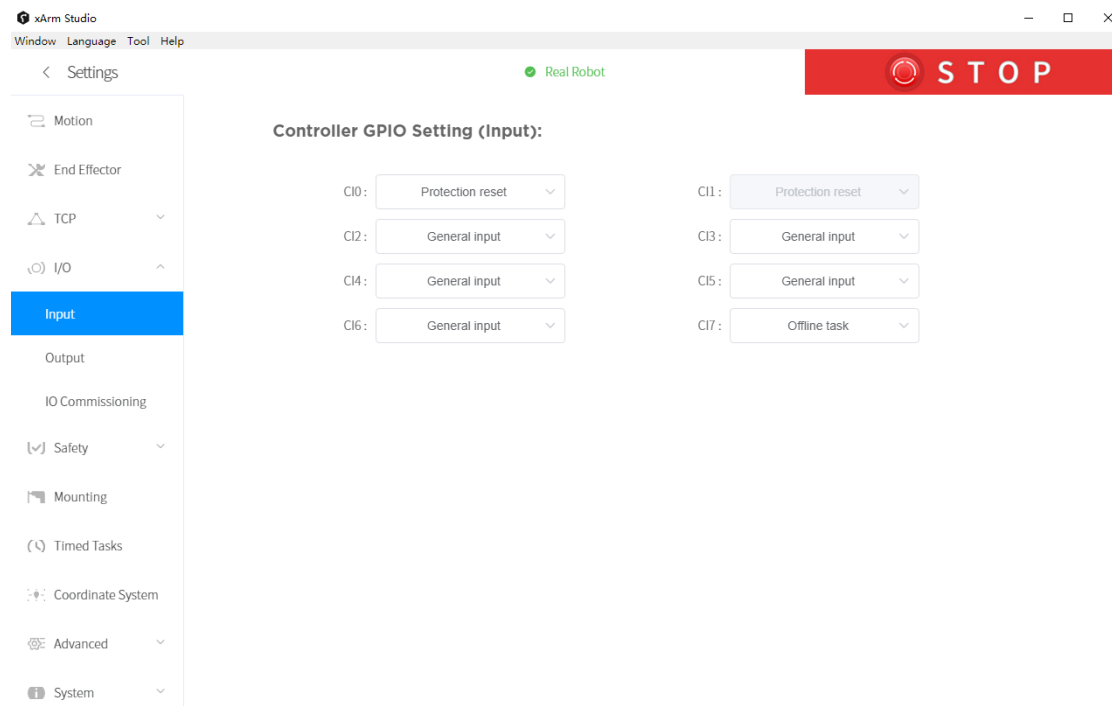

2. If xArm needs to resume motion, connect SI0 and SI1 to GND, and trigger the motion of xArm by connecting CI0 and CI1 to GND; if xArm needs to pause the motion, disconnect SI0 and SI1 from GND.

2.4.3. General Digital I/O Function

2.4.3.1. Configurable Digital Output

The digital output is implemented in the form of NPN. When the digital output is enabled, the corresponding connector will be driven to GND.

When the digital output is disabled, the corresponding connector will be open (OC/OD).

Users must follow the electrical specifications set in section 2.4.1

‘universal specification’ .

The following example shows how to use the digital output, as the internal output is an open-drain(OD) output, so you need to connect the resistor to the power supply according to the load. The resistance and power of the resistor depend on the specific use.

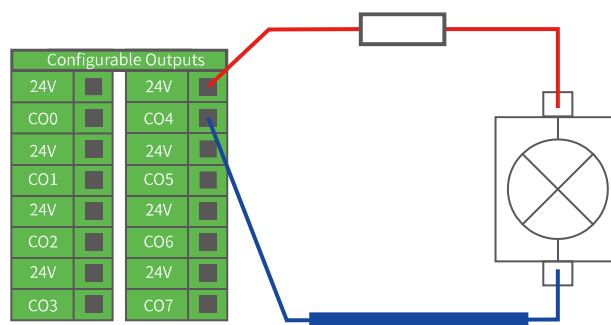

Note: It is highly recommended to use a protection diode for inductive loads as shown below.

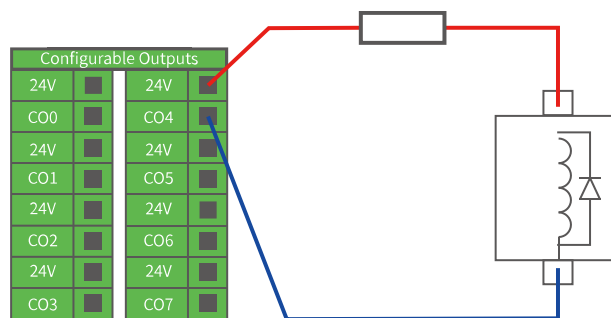

2.4.3.2. Configurable Digital Input

The digital input is implemented in the form of a weak pull-up resistor.

This means that the reading of the floating input is always high.

Users must follow the electrical specifications set in the 2.4.1 'universal specification' . This example shows how a simple button is connected to a digital input.

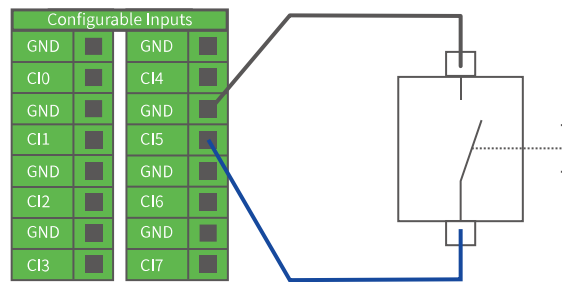

2.4.3.3. Communicate with other Machines or PLCs

If general GND (0V) is established and the machine uses open-drain output technology, digital I/O and other can be used device communication, see the figure below.

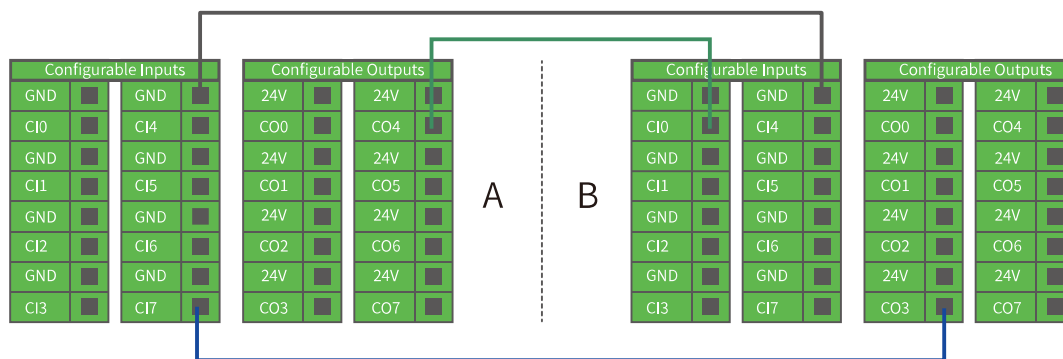

2.4.4. General Analog I/O

This type of interface can be used to set or measure voltage (0-10V) going into or out of other devices.

For the highest accuracy, the following instructions are recommended:

- Use the GND terminal closest to this I/O.
- The device and Control box use the same ground (GND). The analog I/O is not isolated from the control box.
- Use shielded cables or twisted pairs. Connect the shield to the "GND" terminal on the "Power" section.

Terminal	Parameter	Min. Value	Typical Value	Max. Value	Unit
Analog Input under Voltage Mode					
[Alx - AG]	Voltage	0	-	10	V
[Alx - AG]	Resistance	-	10k	-	Ω
[Alx - AG]	Resolution	-	12	12	bit
Analog Output under Voltage Mode					
[AOx - AG]	Voltage	0	-	10	V
[AOx - AG]	Current	0	-	20	mA
[AOx - AG]	Resistance	-	100k	-	Ω
[AOx - AG]	Resolution	-	12	-	bit

2.4.4.1. Analog Output

The following example shows how to use the analog speed control input to control the conveyor belt.(Connect to AO0 or AO1)

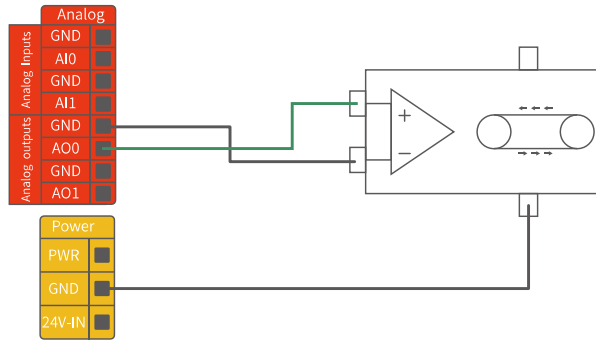

2.4.4.2. Analog Input

The following example shows how to connect an analog sensor.(Connect to AI0 or AI1)

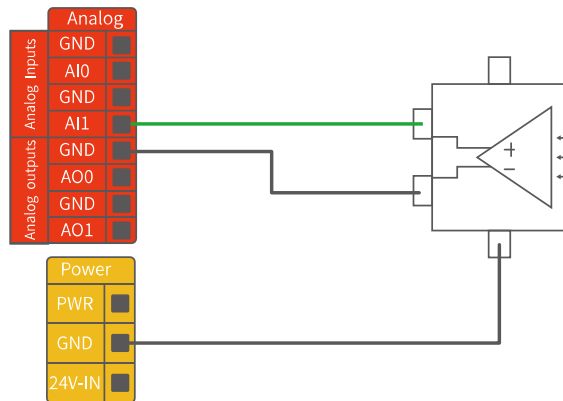

2.5. Communication Interface

The Control Box provides RS-485 interface and Ethernet interface, as shown in the figure below.

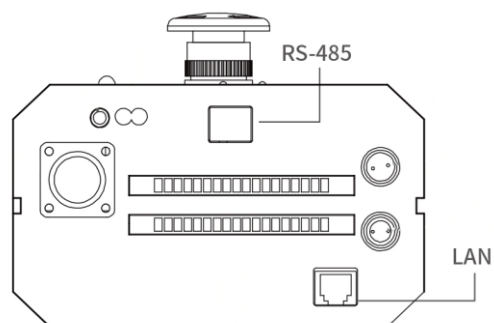

2.5.1. RS-485 Communication

The control box provides an RS-485 interface. (RS-485 communication cable is not factory standard accessory and requires additional purchase)

The control box and the computer are connected through the RS-485 interface, one end of the 485 communication cable is connected with the computer, and the other end is connected with the RS-485 interface of the control box.

2.5.1.1. RS-485 Pin Configuration

Serial Number	Description
1	485_A
2	485_B
3	GND
4	Not connect
5	Not connect
6	Not connect
7	Not connect
8	Not connect

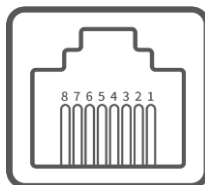

2.6. Ethernet TCP/IP

The control box provides a gigabit Ethernet interface.

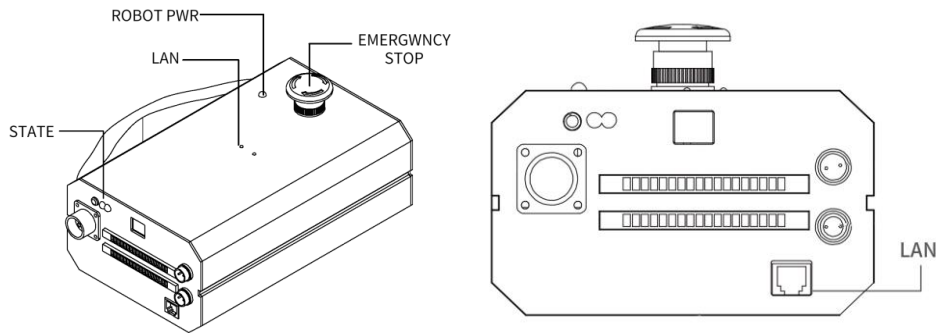

Ethernet connection steps:

- The control box and the computer are connected via Ethernet. One end of the network cable is connected to the network interface of the control box, and the other end is connected to the computer or LAN network interface. If the connection is successful, the network port indicator blinks frequently.

The default network segment IP address of the control box is 192.168.1.*(2~254). For a specific IP address, please check the control box label. When communicating with the robotic arm, the IP address of the computer should be in the same network segment with the IP address of the control box.

Note:

To connect with Ethernet, please check if the computer's IP address is 192.168.1.*, check if the network proxy is enabled, and check if the robotic arm's IP address conflicts with that of other devices in the LAN. Please change the computer IP address to the same network segment and close the computer's network proxy. To test whether the computer

can communicate with the robotic arm, open the command terminal and input 'ping 192.168.1.* (the IP address of the robotic arm)'. If the ping is working, the communication between the computer and the robotic arm is successful.

3. End-Effector

3.1. Gripper

The gripper is the end-effector of the robotic arm, which can grasp objects dynamically.

The value range of the gripper opening and closing is: -10 to 850. The larger the value, the greater the stroke of the gripper, meaning the smaller the value, the smaller the stroke of the gripper. If the clamping is not tight, a negative value can be set until it is tightened.

The speed of the gripper should be in 1000-5000. If a speed less than 1000 was set, the gripper may not work. The speed of the gripper opening needs to be greater than or equal to the speed of the gripper closing.

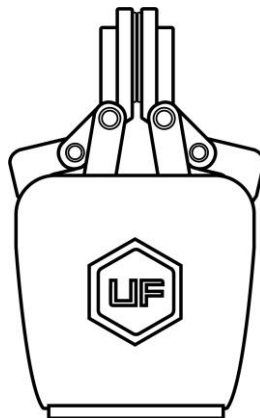

3.1.1. Gripper Installation

Installation of gripper:

1. Move the robotic arm to a safe position. Avoid collision with the robotic arm mounting surface or other equipment;
2. Power off the robotic arm by pressing the emergency stop button on the control box;
3. Fix the gripper on the end of the robotic arm with 2 M6 bolts;
4. Connect the robotic arm and the gripper with the gripper connection cable;

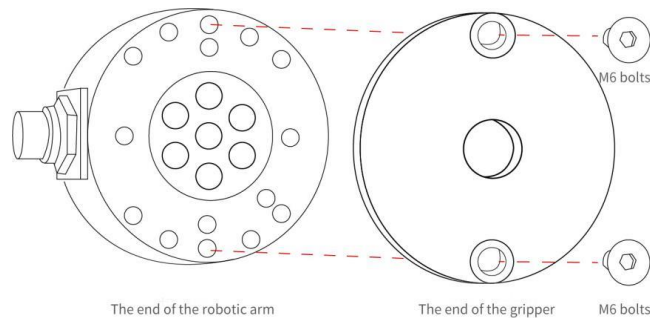

Note:

1. When wiring the gripper connection cable, be sure to power off the robotic arm, to set the emergency stop button in the pressed state, and to ensure that power indicator of the robotic arm is off, as to avoid robotic arm failure caused by hot-plugging;
2. Due to limited length of the gripper connection cable, the gripper connector and the tool/end effector connector must be on the same

side;

3. When connecting the gripper and the robotic arm, be sure to align the positioning holes at the ends of the gripper and the robotic arm. The male pins of the connecting cable are relatively thin, please be careful to avoid bending the male pins during disassembly.

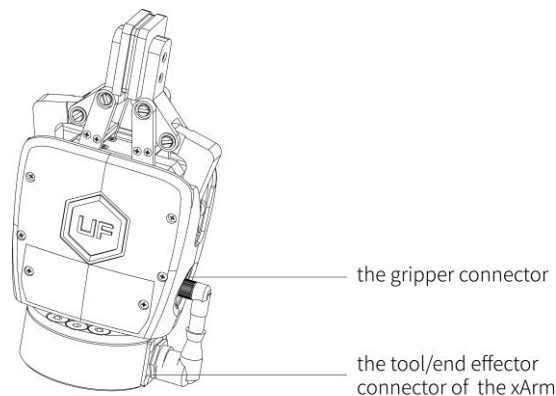

3.1.2. The Flow of Gripper Movement

1. Enable the gripper.
2. Send out a position for clamping.
3. The current range of value: -10 ~ 850.

3.1.3. Precautions



DANGER

1. When the robotic arm is in the zero position, the gripper will exceed the installation surface. Please adjust the robotic arm to a posture suitable for installing the gripper during installation.

2. When a robotic arm equipped with a gripper is used

for trajectory planning, it is necessary to perform a safety assessment on whether to return to the zero-point or whether the operation can be performed and to avoid collisions.

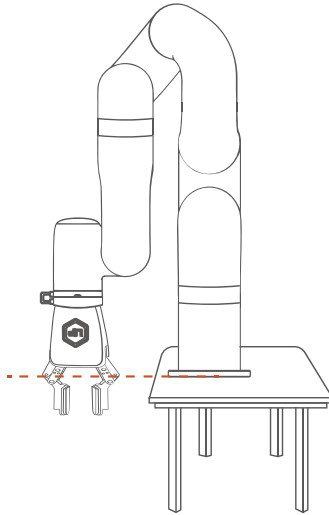

The gripper of the robotic arm in the zero position will exceed the mounting surface.

Note:

For detailed instructions on the xArm gripper, please refer to the xArm gripper user manual, download link:

<https://www.ufactory.cc/pages/download-xarm>

3.2. Vacuum Gripper

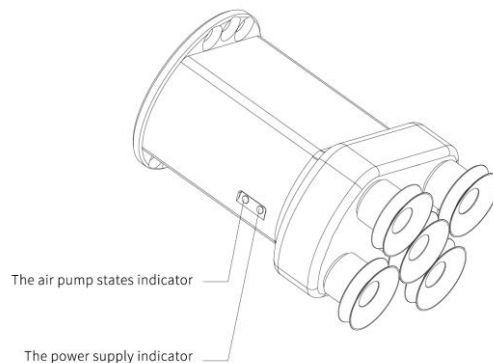

The vacuum gripper can dynamically suck the smooth plane object with payload $\leq 5\text{kg}$. The vacuum gripper is equipped with 5 suction cups, which can be partially selected for use according to the size of the object surface, and the unused suction cup needs to be sealed.

Note:

If the surface of the object is not smooth, there will be air leakage from the suction cup which makes the object fail to be sucked up firmly.

Indicator status: When the vacuum gripper is powered on, the power supply indicator near the vacuum gripper is constantly red. When the vacuum gripper is on, the IO status indicator is constantly green.

3.2.1. Vacuum Gripper Installation

Installation of vacuum gripper:

1. Move the robotic arm to a safe position. Avoid collision with the

- robotic arm mounting surface or other equipment;
2. Power off the robotic arm by pressing the emergency stop button on the control box;
 3. Fix the vacuum gripper on the end of the robotic arm with 2 M6 bolts;
 4. Connect the robotic arm and the vacuum gripper with the vacuum gripper connection cable.

Note:

1. When turning on the vacuum gripper connection cable, be sure to power off the robotic arm, to set the emergency stop button in the pressed state, and to ensure that power indicator of the robotic arm is off, as to avoid robotic arm failure caused by hot-plugging;
2. Due to the length limitation of the vacuum gripper connection cable, the vacuum gripper interface and the tool IO interface must be in the same direction;
3. When connecting the vacuum gripper and the robotic arm, be sure to align the positioning holes on the two ends of the interface. The male pins of the connecting cable are relatively thin to avoid bending the male pins during disassembly.

3.2.2. Turn On/Off Vacuum Gripper

Example:

Blockly:

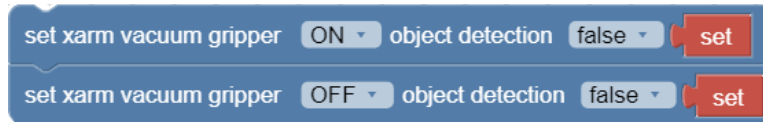

Python-SDK:

```
arm.set_vacuum_gripper(True, wait=False) #Turn on vacuum gripper  
arm.set_vacuum_gripper(False, wait=False) #Turn off vacuum gripper
```

Note:

1. Python-SDK and xArm Studio provide wrapped functions that can be called to turn on/off the vacuum gripper.

[xArm Studio-Blockly Command-End Effector-Vacuum Gripper.](#)

2. For detailed instructions on the xArm vacuum gripper, please refer to the xArm vacuum gripper user manual, download link:

<https://www.ufactory.cc/pages/download-xarm>

xArm User Manual-Software Section

1. xArm Studio

xArm Studio is a graphical user application for controlling the robotic arm. With this application, you can set parameters, move the robotic arm in live control, and create a motion trajectory by simply drag and drop the code blocks of Blockly. xArm Studio allows users to plan the motion trajectory for the robotic arm without programming skills.

Note:

1) Installation systems supported by the xArm Studio client: Windows, Mac, Linux (Ubuntu16.04)

2) On Windows(Mac/Linux) computers, iPad, Android tablets and Raspberry Pi 4B, you can access xArm Studio through a browser.

xArm Studio is now compatible with browsers:

Google Chrome/ Firefox / Safari /Microsoft Edge (Chromium kernel)

1.1 Hardware Preparation

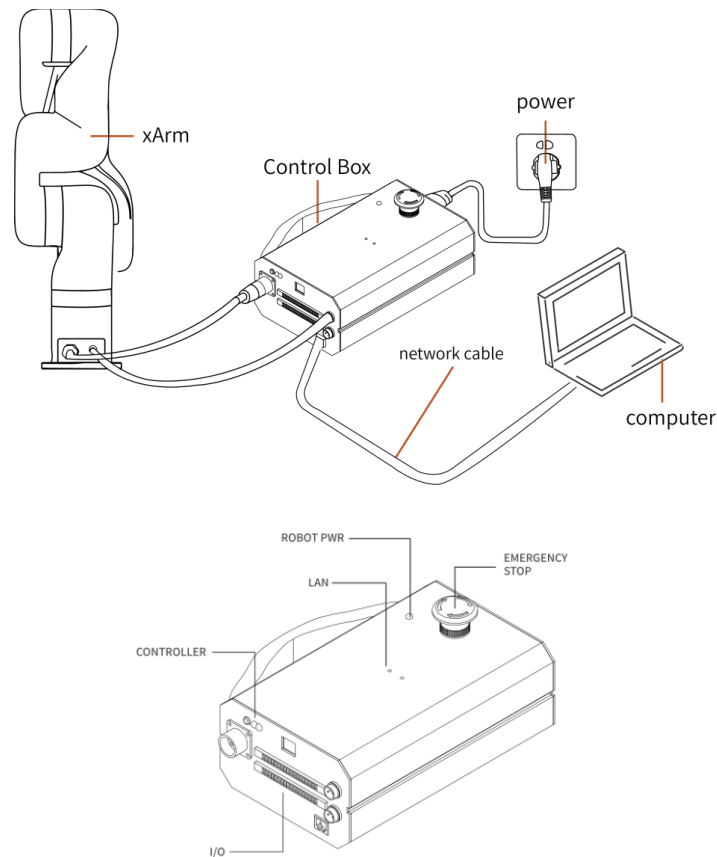

Before using xArm Studio, you must ensure that the hardware is installed correctly and all the protective measures for the workplace environment have been implemented.

1. The robotic arm is fixed on the plane; protective measures are in place within the range of motion.
2. Check if the connection between the control box and the robotic arm, power supply, and network cable is stable.
3. Check if the main power of the control box is on. If the ON/OFF light is on it means power is on.

4. Check if the control box is turned on, if the status indicator of the control box is on, it means the control box is turned on.
5. Check if the network is connected. If the network indicator in the middle of the control box flashes frequently, it means the network communication is normal.
6. Check if the robotic arm is powered and the emergency stop button is disabled. If the power indicator of the robotic arm lights up, it means the power is on.

1.2 Connect to the Robotic Arm

1.2.1 The Robotic Arm Network Settings

There are four ways of network settings for the robotic arm. You can choose the appropriate network setting method according to your scenario:

- (1) The control box is directly connected to the PC.

Note: Recommended connection method.

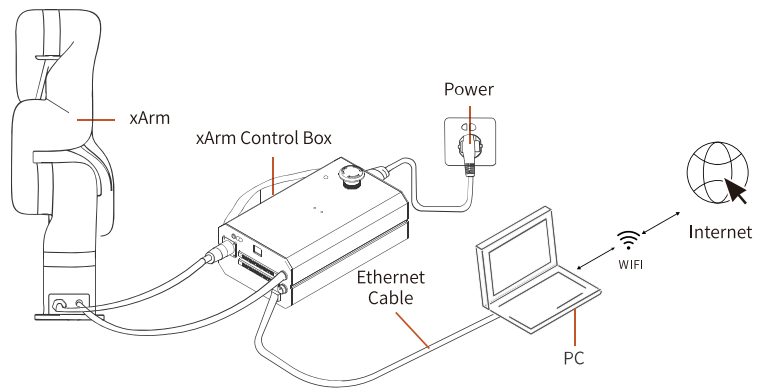

(2) The control box, PC and router are connected by Ethernet cable.

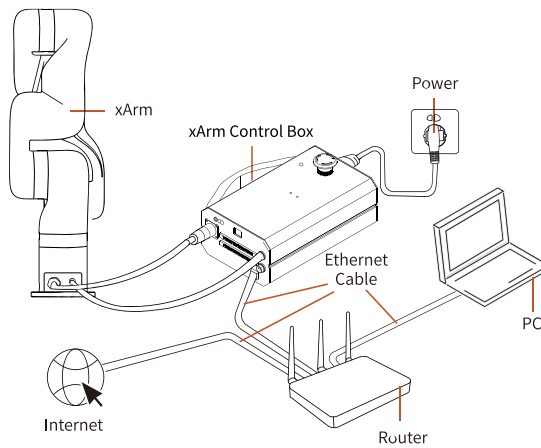

(3) PC and router are connected by wireless network, and control box and router are connected by Ethernet cable.

Note: It is not recommended because of the delay and packet loss of wireless connection.

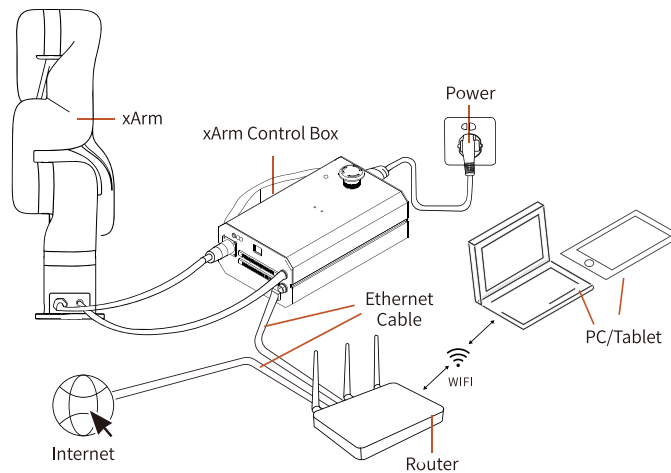

(4) The control box, PC and network switch are connected by Ethernet cable.

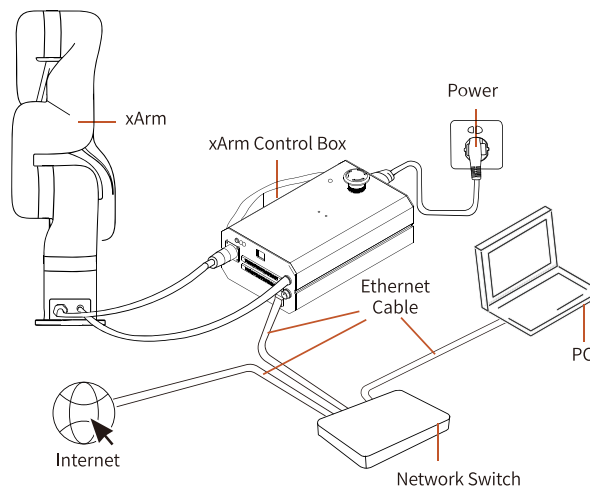

1.2.2 IP Configuration

Before connecting the robotic arm with xArm Studio (communication with the robotic arm), make sure that the IP address of the computer and the IP address of the control box are on the same network segment.

When the control box is shipped from the factory, the default IP address is 192.168.1.xxx (The factory IP address of the device has been

marked on the side of the control box). Therefore, to successfully communicate with the control box, the IPV4 network segment on the computer must be between 192.168.1.1-192.168.1.255 (cannot be the same as the IP address tail number of the control box).

- IP Setting

Network and Sharing Center → Ethernet → Properties → IPV4

Step1: Open the “Network and Sharing Center”

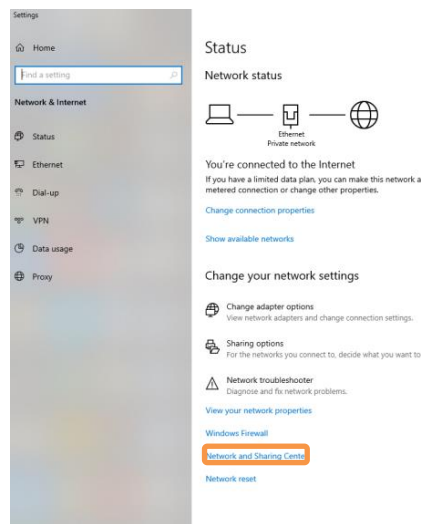

Step2: Open the “Ethernet”

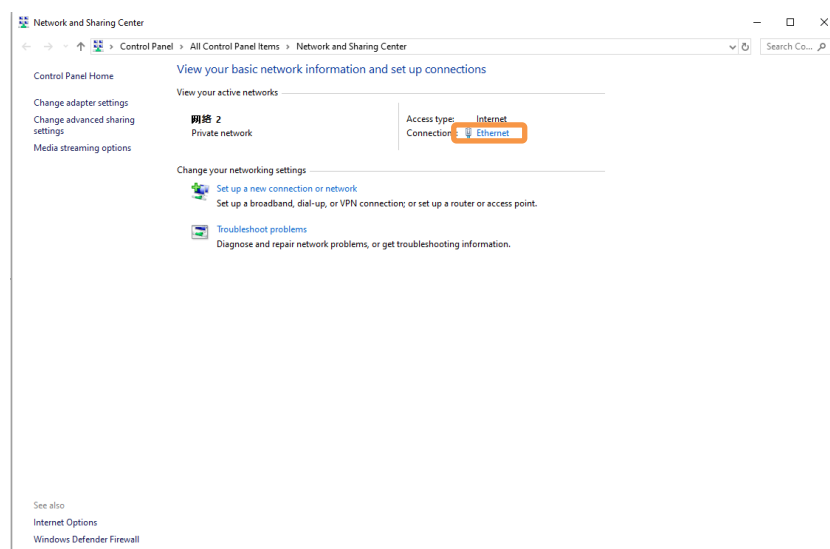

Step3: Open the "Properties"

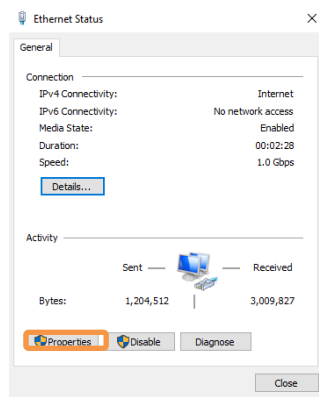

Step4: Open the "IPV4"

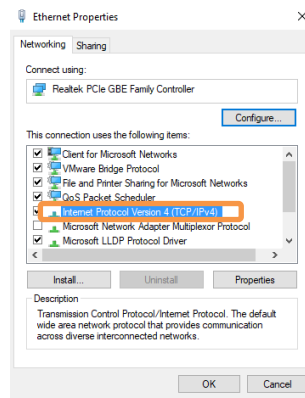

Step5:

Then check whether the computer IP is within 192.168.1.1-192.168.1.255 (the tail number should be 1 to 255, and can not be the same as the IP address of the control box). If not, please modify the computer's IP.

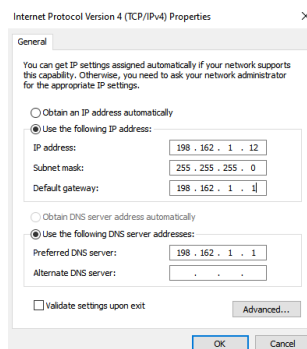

Step6:

After the modification is completed, please verify the IP address of the computer: enter cmd in the search box (see the figure below), open a command prompt, and directly ping the IP address of the xArm in the command line: ping 192.168.1.XXX (see the figure below). You can successfully send and receive data packets.

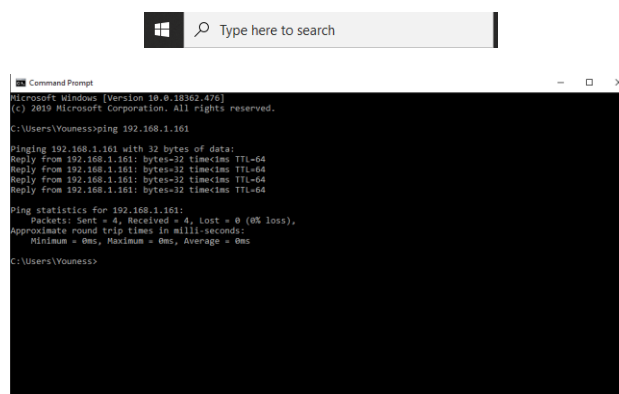

1.2.3 Connect to the Robotic Arm

There are the following two ways to communicate with the robotic arm.

1. If you access xArm Studio software, you can communicate with the robotic arm through the following steps:

(1) Download xArm Studio

xArm Studio download address:

<https://store-ufactory-cc.myshopify.com/pages/download-xarm>

(2) Install xArm Studio software

(3) Open the xArm Studio software, and enter the IP address of the control box in the search box (the default IP address of the device has been marked on the side of the control box)

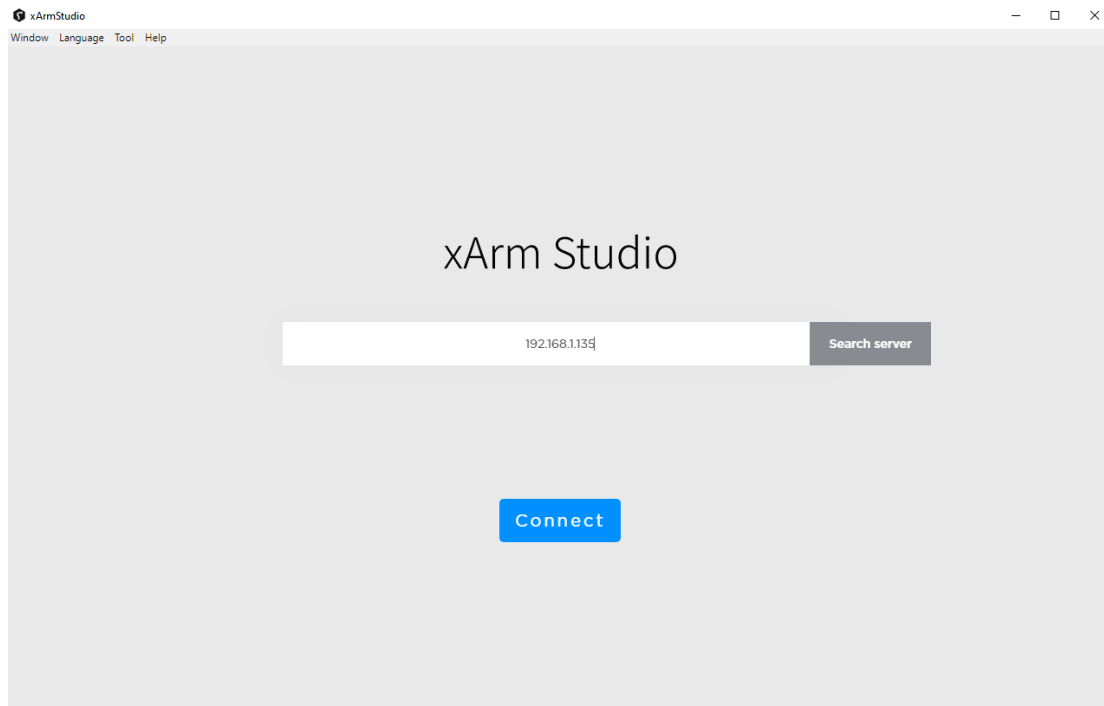

2. If you use a browser to access xArm Studio, you can communicate with the robot through the following steps:

(1) Open the browser

(2) Enter in the search bar: the IP address of the control box: 18333

For example, if the IP address of the control box is 192.168.1.135,

enter 192.168.1.135:18333 in the search bar to access xArm Studio.



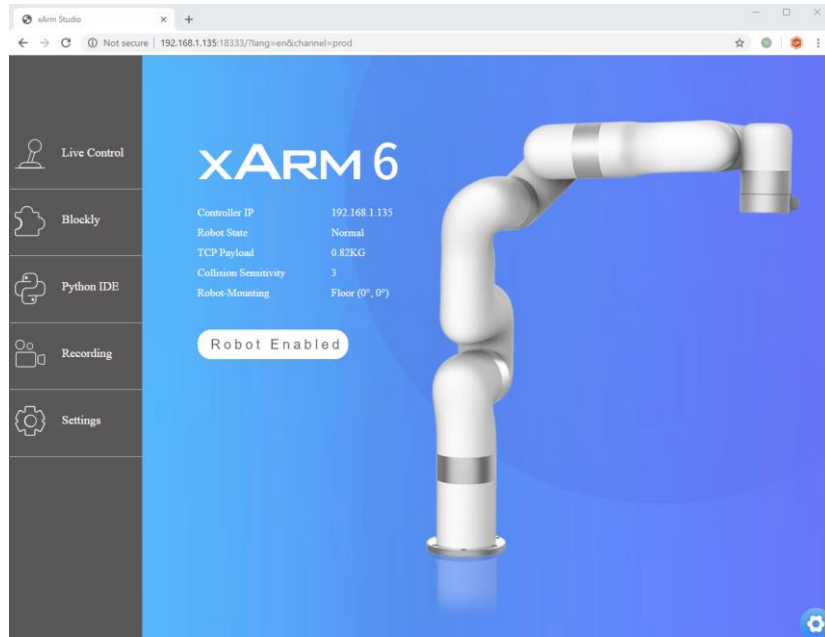

1.2.4 Return to the Search Interface

Window Language Tool Help

PC: Click **【Tool】** - **【Search】** to return to the search interface.

1.3 xArm Studio Homepage

1.3.1 xArm Studio Homepage Parameters



The homepage displays the number of axes currently connected to the robotic arm, Controller IP, Robot State, TCP Payload, Collision Sensitivity, Robot-Mounting, and Motion Enable.





Robot State:

【Error】 indicating that the robotic arm has not been enabled, or the robot is in error state. Click the blue **【Enable Robot】** button to enable it.

【Normal】 indicating that the robotic arm is ready, and **【Enable Robot】** becomes **【Robot Enabled】** .

1.3.2 5 Main Functional Modules of xArm Studio

xArm Studio mainly consists of 5 main functional modules:

 Live Control	Live Control: Gives the ability to control the position of the xArm and adjust its posture.
 Blockly	Blockly: A graphical programming tool that allows users to achieve programming for the control of the robotic arm , I/O, or end-effector by simply drag and drop the code blocks.
 Python IDE	Python IDE: Python integrated development environment that uses the xArm-Python-SDK API directly and has ability to view the Python code generated by the Blockly project.
 Recording	Recording: To record the trajectory of the robotic arm in manual mode, the maximum recording time is 5 minutes.
 Settings	Settings: Set the parameters of the robotic arm, upgrade the system software, etc.

1.3.3 Toolbar

Window Language Tool Help

Window: To adjust its size, you can make a selection in the **【Window】** drop-down menu or adjust the size by dragging the border of the window.

Language: Switch language in the upper right corner of the toolbar - **【Language】** may switch between Simplified Chinese / English.

Tool: 【Tools】 - 【Search】 to return to the interface of 'search the robotic arm' .

【Tools】 - 【Check for Updates】 to check the software updates.

Help: 【Help】 Use the drop-down window to download the manuals of the robotic arm, contact technical support, open forums, and visit GitHub.

1.4 Robotic Arm Setting

Click the 【Settings】 button on the home page to enter the robotic arm setting interface. Set the desired parameters according to the actual situation.

1.4.1 Motion Settings

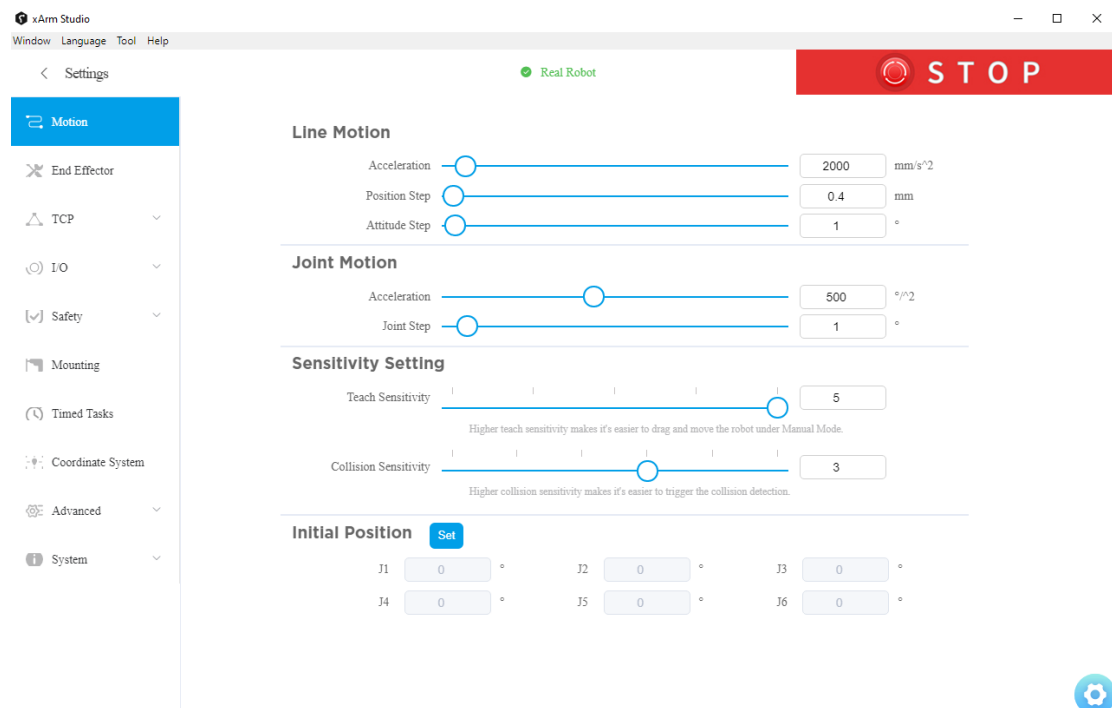

The screenshot shows the xArm Studio software interface. At the top, there is a menu bar with 'Window', 'Language', 'Tool', and 'Help'. Below the menu bar, there is a navigation pane on the left with a 'Settings' button. The main area displays the 'Motion' settings for a 'Real Robot'. A red 'STOP' button is visible in the top right corner. The settings are organized into several sections:

- Line Motion:** Acceleration (2000 mm/s²), Position Step (0.4 mm), Attitude Step (1 °).
- Joint Motion:** Acceleration (500 °/s²), Joint Step (1 °).
- Sensitivity Setting:** Teach Sensitivity (5), Collision Sensitivity (3).
 - Higher teach sensitivity makes it's easier to drag and move the robot under Manual Mode.
 - Higher collision sensitivity makes it's easier to trigger the collision detection.
- Initial Position:** A 'Set' button and six input fields for joints J1 through J6, all set to 0 °.

1.4.1.1 Linear Motion

Acceleration: The acceleration of linear motion. The larger the value, the less time it takes to reach the set speed. It is recommended to be set within 20 times the maximum speed value for a smooth trajectory.

Position step: Set the step length for fine cartesian position(X/Y/Z) adjustment in Live-control.

Attitude step: Set the step length for fine adjustment of TCP orientation in Live-control.

1.4.1.2 Joint Motion

Acceleration: The acceleration of joint motion. The larger the value, the less time it takes to reach the set speed. The range is recommended to be within 20 times the maximum operating speed [20*180°/s].

Joint step: Set the step length for fine adjustment of single joint rotation in Live-control.

1.4.1.3 Sensitivity Setting

Collision sensitivity:

- When the deviation of the torque detected by the joint exceeds a certain normal range during the movement of the robotic arm, the robotic arm will automatically stop to prevent the robotic arm or the operator from being injured. The collision sensitivity range is 0 to 5 levels. When it is set to 0, it means that collision detection is not enabled. The larger the value is set, the higher the collision sensitivity level is, and the smaller the additional torque required for the robotic arm to trigger collision protection. If the load or installation direction is not set accurately, it may cause false alarms. During certain high loads or high speed movements, if you confirm that the load or installation direction is set accurately, you can try to lower the collision sensitivity, but it is not recommended to lower it to less than 3.

Teach sensitivity:

- The level of Teach sensitivity is from 1 to 5. The higher the set value, the smaller the force required to drag the joint in manual mode.

1.4.1.4 Initial Position

Setting the Initial Position of the robotic arm can help the user to return the robotic arm to a relatively safe position when planning the motion trajectory.

Steps for setting the initial position:

1. Click **【Settings】** button on the homepage.
2. Enter **【Motion】** ,then click the **【Set】** button next to the Initial Position.
3. Set the initial position of the xArm in Live-control.

【Confirm】 : Save the changes.

【Cancel】 : Cancel the changes.

The screenshot shows the xArm Studio Settings interface. The left sidebar contains a menu with options: Motion (selected), End Effector, TCP, I/O, Safety, Mounting, Timed Tasks, Coordinate System, Advanced, and System. The main content area is titled 'Settings' and includes a 'Simulate Robot' button and a red 'STOP' button. The settings are organized into sections:

- Line Motion:** Acceleration (2000 mm/s²), Position Step (1 mm), Attitude Step (1 °).
- Joint Motion:** Acceleration (500 °/s²), Joint Step (1 °).
- Sensitivity Setting:** Teach Sensitivity (3), Collision Sensitivity (4).
Higher teach sensitivity makes it's easier to drag and move the robot under Manual Mode.
Higher collision sensitivity makes it's easier to trigger the collision detection.
- Initial Position:** A blue 'Set' button is next to the section title. Below it, six input fields are shown for joints J1 through J6, with values: J1: -34.9 °, J2: -24.2 °, J3: -27.4 °, J4: 0 °, J5: 0 °, J6: 0 °.

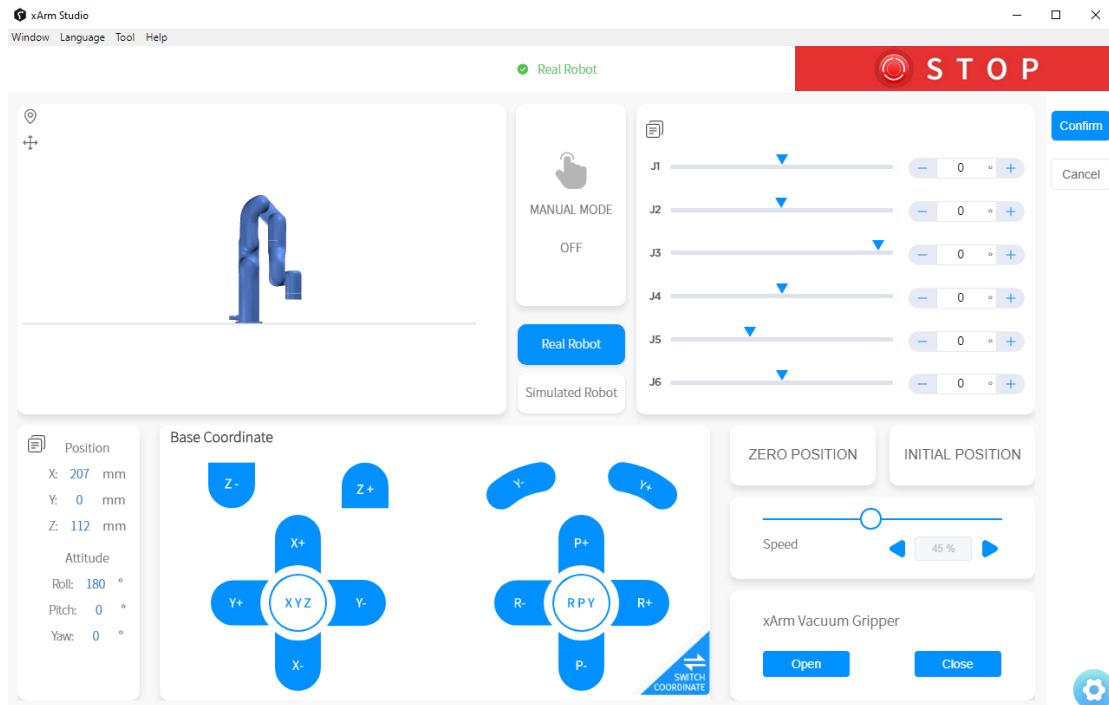

1.4.2 End Effector

- **When the end effector provided in the option is installed at the end of the xArm, select the corresponding end effector.**

The end effectors currently supported by xArm are: xArm Gripper, xArm vacuum Gripper, xArm BIO Gripper, Robotiq-2F-85 Gripper, Robotiq-2F-140 Gripper.

Take the xArm Gripper as an example.

xArm Gripper

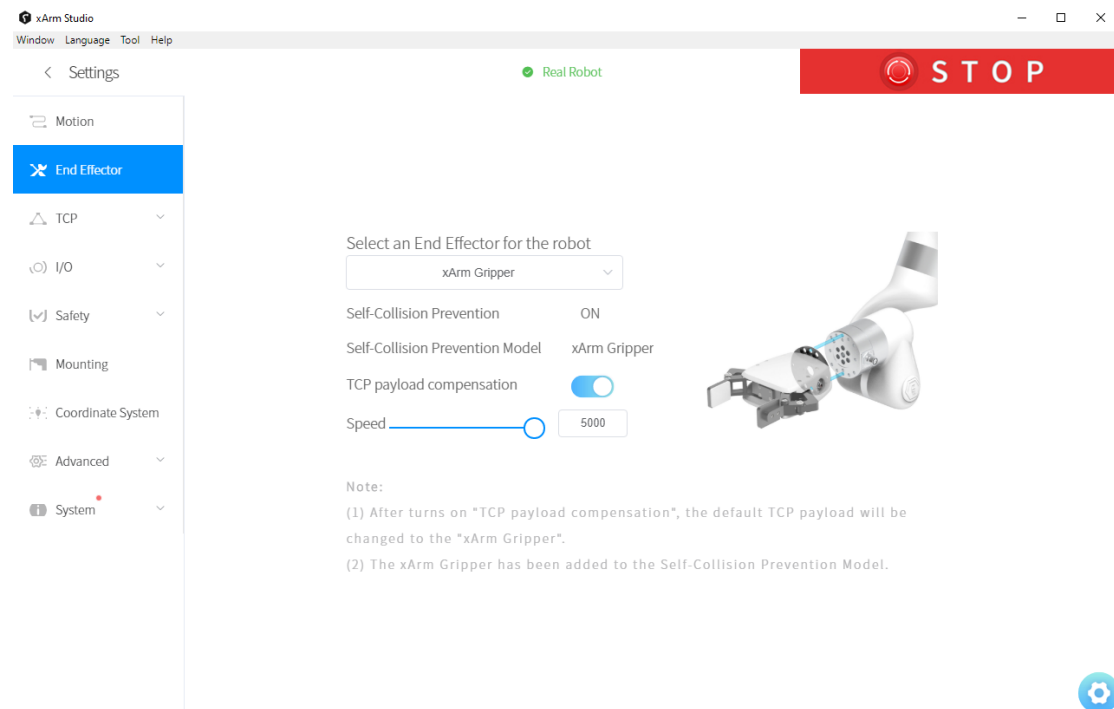

Note:

1. The opening and closing speed of the gripper can be adjusted.
2. The self-collision prevention model of the gripper can be turned on by clicking the button.
3. When "TCP payload compensation" is turned on, the default TCP payload will be changed to the TCP payload parameter of the gripper.

- **When installing other end effectors (not officially provided) at the end of the robotic arm, please choose **[other]** .**

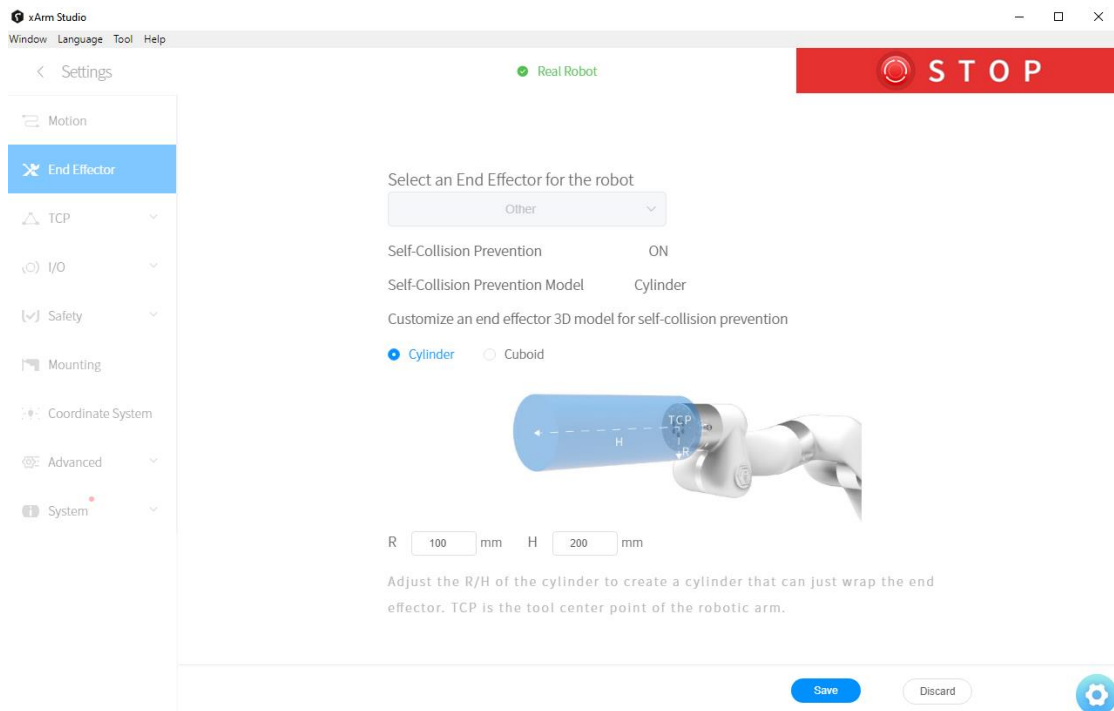

1. You can choose a 3D model (cylinder/cuboid) that can wrap the end effector and use it as the self-collision prevention model of the end effector.

- **When no end effector is installed at the end of the robotic arm, select [No End Effector]**

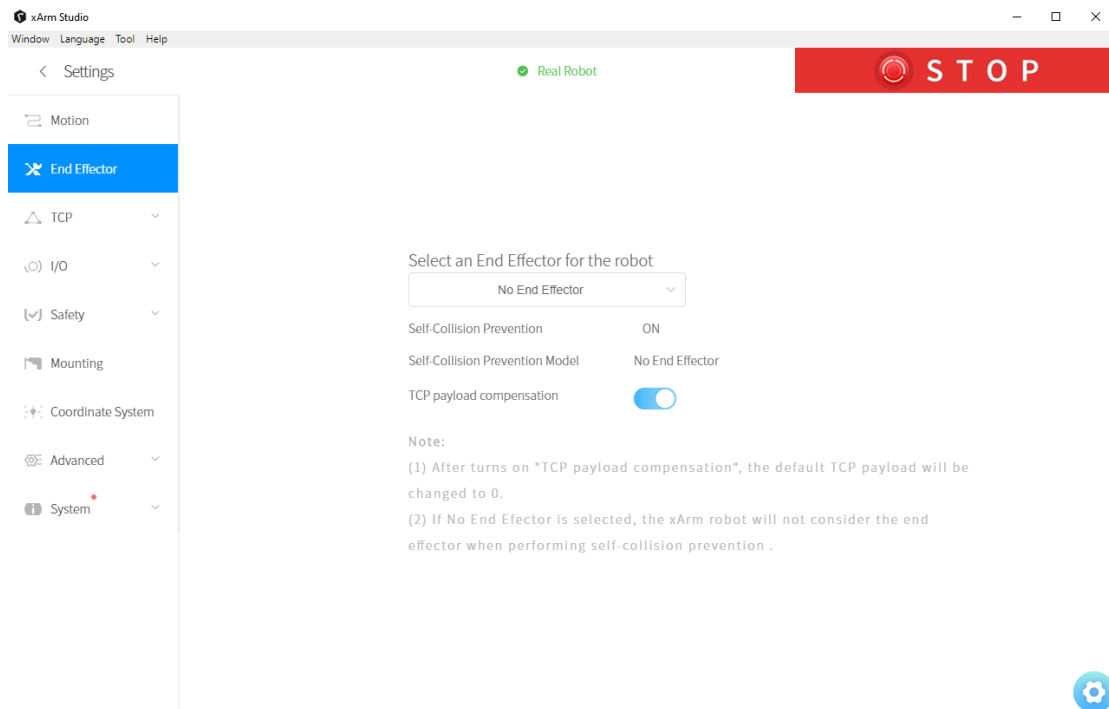

1.4.3 TCP Settings

Set TCP Payload and TCP Offset according to the actual situation.

【TCP Payload】

- The load weight refers to the actual mass (end-effector + object) in Kg; X/Y/Z-axis represents the position of the centre of gravity of payload in mm, this position is expressed in default TCP coordinate located at flange center(Frame B in the above figure) . If there is virtually no load at the end, both TCP payload and centre of gravity must be set to 0.

【TCP Offset】

- Setting the Tool Coordinate Offset with respect to the initial tool frame located at the center of the flange (Frame B in the above figure) . The position coordinates X, Y, and Z determine the position of TCP, while Roll, Pitch, and Yaw determine the orientation. When the specified value is zero, TCP coincides with the centre point of the tool output flange.

1.4.3.1 TCP Payload

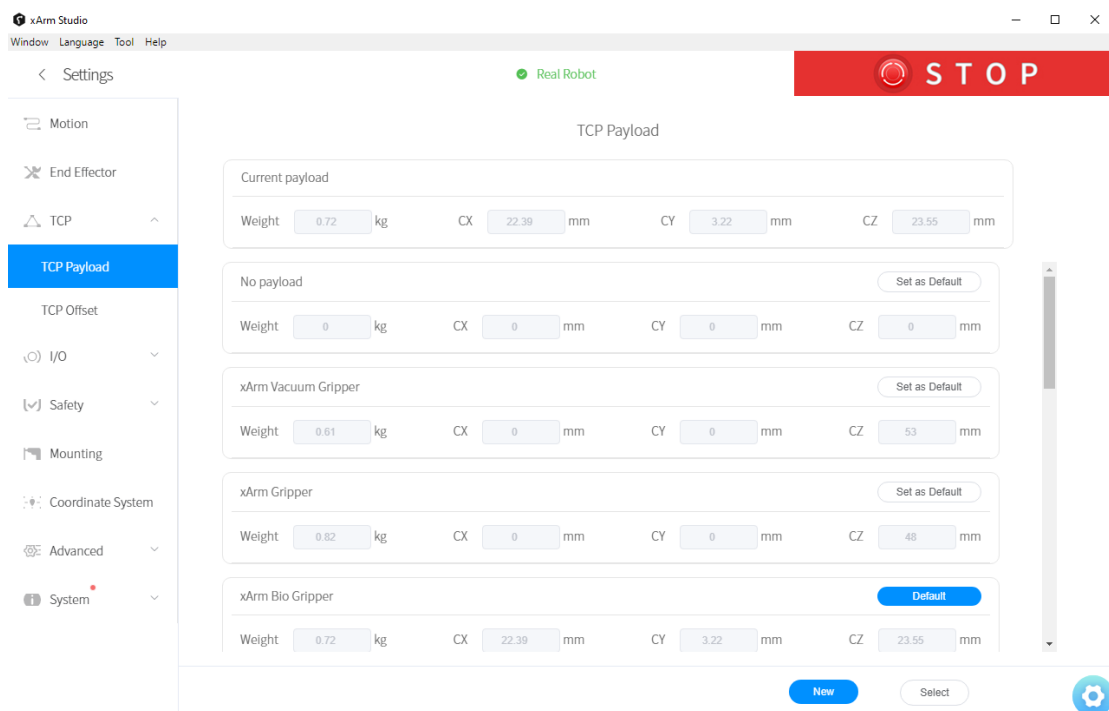

On this page, the current payload of the robotic arm can be set and the additional TCP payload data can be recorded. The additional TCP payload data can be referenced during Blockly programming.

【Set as default】

- Set the payload data to the payload of the current robotic arm and display the current payload at the top, which is used for controlling the entire robotic arm and is related to the normal use of manual mode and collision detection.

【New】 : Create new payload data.

【Select】 : Select the payload data to be deleted in the next step.

【Delete】 : Delete the selected payload data. Note: the current default payload data cannot be deleted.

【Save】 : Save for the newly added payload record, setting the default payload, and deleting the payload record.

【Cancel】 : Cancel saving the newly added payload record, setting the default payload, or deleting the payload record.

Create New TCP Payload

There are two ways to create a new TCP payload:

Manual input or Automatic identification. Manually inputting can be selected if the weight of the payload and the approximate center of gravity of the payload are known. The center of gravity of the payload is

set based on the initial tool coordinates (the coordinates of point B shown in the above figure).

The current robotic arm must be mounted on a steady floor if automatic identification is selected. The robotic arm needs to run a series of action commands to calculate the parameters of TCP payload.

In addition, it is important to ensure the safety of equipment and personnel near the robotic arm.

Note: Once the name of the new payload has been determined, it cannot be changed.

1.4.3.2 TCP Offset

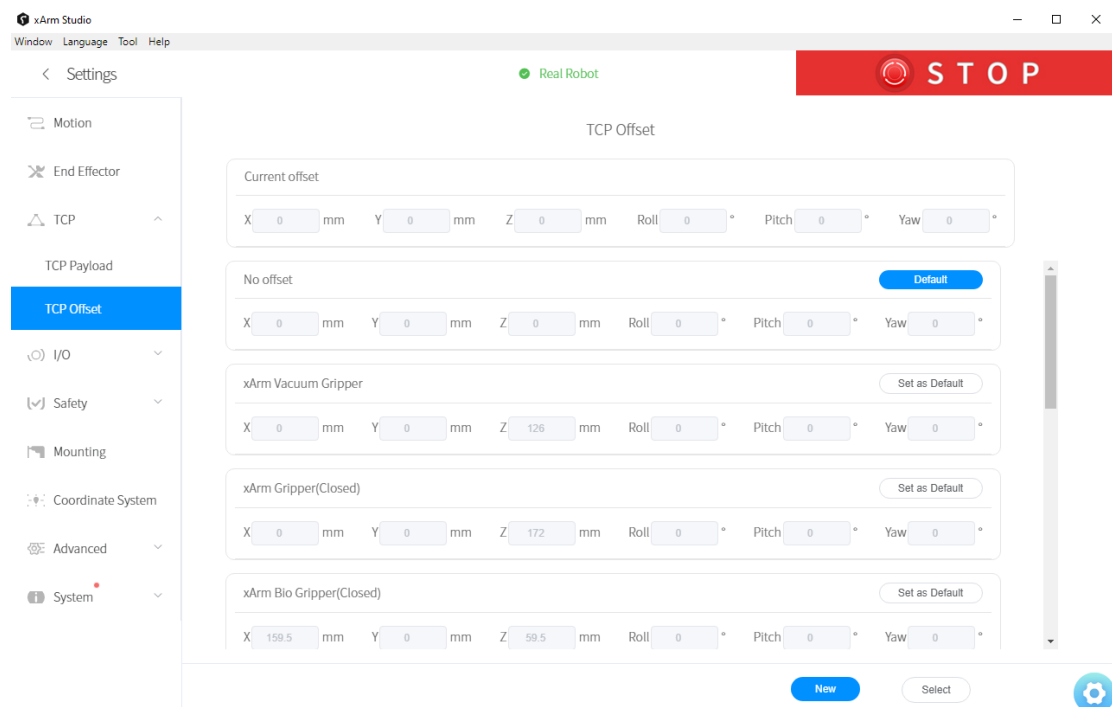

On this page, the current offset of the robotic arm can be set and the

additional TCP offset data can be recorded. The additional TCP offset data can be referenced during Blockly programming.

【Set as default】 : Set the offset data to the offset of the current robotic arm and display the current offset at the top.

【New】 : Create a new offset record.

【Select】 : Select the offset data to be deleted in the next step.

【Delete】 : Delete the selected offset data.

Note: the current default offset data cannot be deleted.

【Save】 : Save for the newly added offset record, setting the default offset, and deleting the offset record.

【Cancel】 : Cancel saving the newly added offset record, setting the default offset, and deleting the offset record.

1.4.4 I/O Settings

The control box of the robotic arm is equipped with 8 digital input and output signals, which can be set in the Blockly project and SDK only when IO is set to General Input / Output. Otherwise the custom setting will not take effect.

1.4.4.1 Input

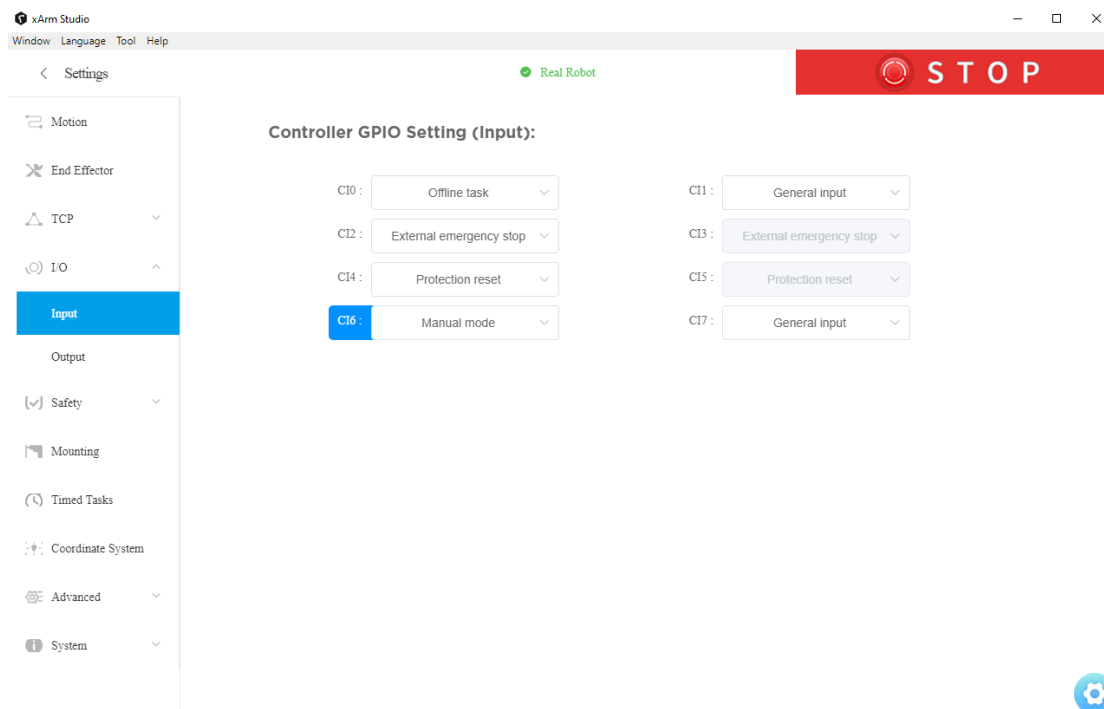

The following functions (if configured), can be triggered by low-level input signals.

【General Input】

- The input signal can be configured, and only after setting the General Input function, the user can freely configure when programming Blockly or using SDK.

【External Emergency Stop】

- When External Emergency Stop is selected as the safe IO, the adjacent IO is set to the external emergency stop in pairs. For example, if CIO0 is set to an external emergency stop, CIO1 will also be used as an input signal of the external emergency stop. CIO2 and CIO3 pairing, CIO4 and

CI5 pairing, CI6 and CI7 pairing, and so on.

【Offline Task】

- Offline Task can add multiple Blockly to be triggered through programs I/O, and without the need for computer and network. As shown in the figure above, CI4 is set to the function of Offline Task and a Blockly project is added. Click **【Add】** to add a Blockly project, and click **【✕】** to delete the project.

【Manual Mode】

- When setting to the function of Manual Mode, the robotic arm can be dragged freely when the input signal remains low power levels.

【Save】

- Save the changes.

【Cancel】

- Discard the changes.

1.4.4.2 Output

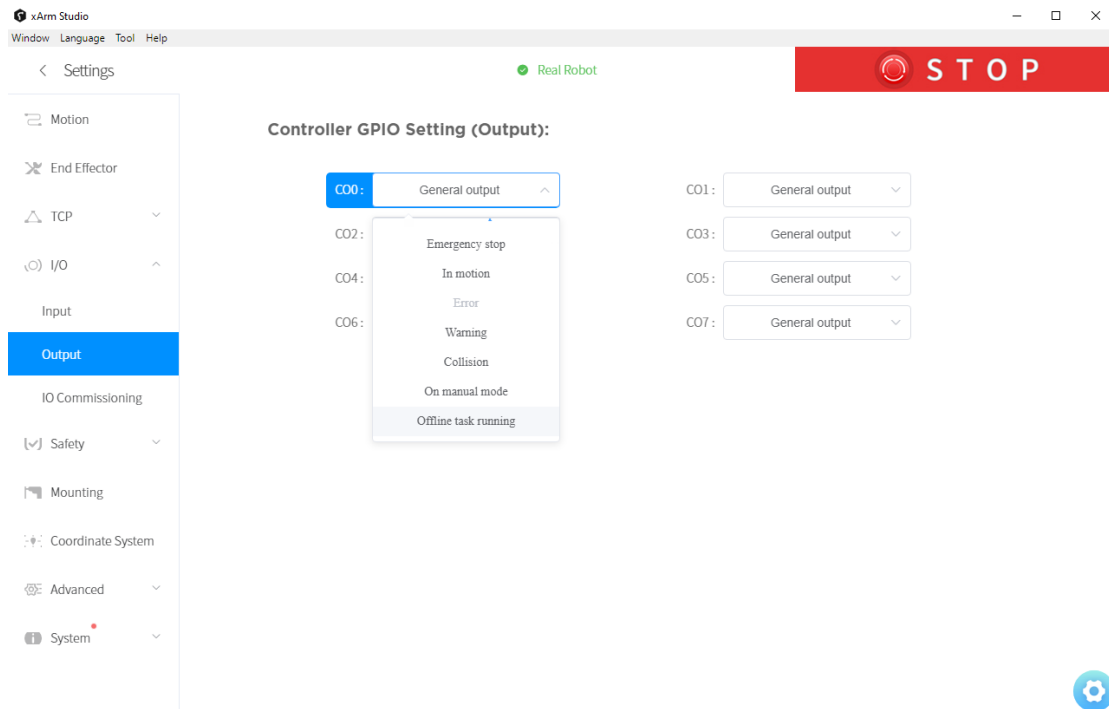

The below functions can be configured for each output.

【General Output】

- General purpose output, can be configured in programs to output signals.

【Emergency Stop】

- The system enters an emergency stop state and outputs a low level signal. Otherwise, the output is high. This safety function will come in pairs for redundancy.

The actions that conform to the emergency stop are:

1. When the Emergency Stop button of the control box is pressed, the

power supply of the robotic arm is cut off.

2. Stop button of xArm Studio and Emergency stop code block of Blockly.

3. IO input is set to an emergency stop.

4. Emergency stop API of SDK.

【In motion】

- When the robotic arm is in motion, the output is low. The robotic arm outputs a high level when in a fixed position. This safety related IO will come in pairs.

【Error】

- When the robotic arm reports an error, the output is low. Otherwise, the output is high.

【Warning】

- When the robotic arm issues a warning, the output is low. Otherwise, the output is high.

【Collision】

- When the robotic arm reports an error of collision, the output is low. Otherwise, the output is high.

【On manual mode】

- When the Manual Mode is turned on, the output is low.

Otherwise, the output is high.

【Offline task running】

- When the robotic arm is running the offline projects, the output is low.

Otherwise, the output is high.

1.4.4.3 IO Commissioning

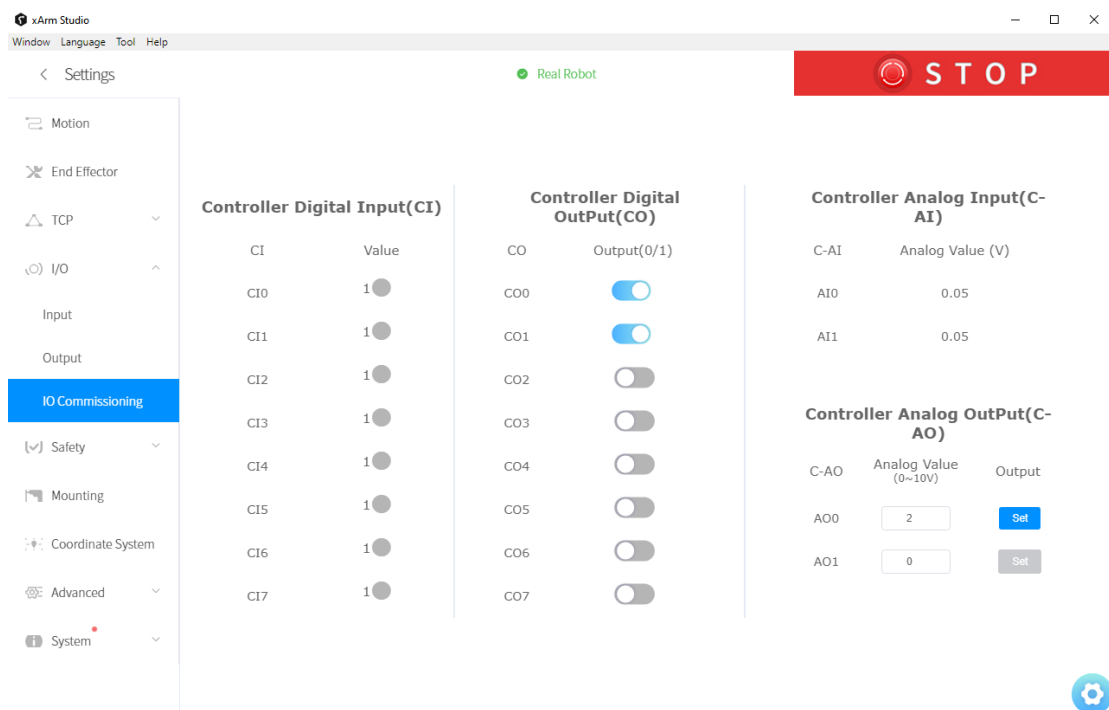

In this interface, the IO input status and IO output status of the control box can be monitored, and the IO output status of the control box can be controlled by clicking the button.

1.4.5 Safety Settings

1.4.5.1 Safety Boundary

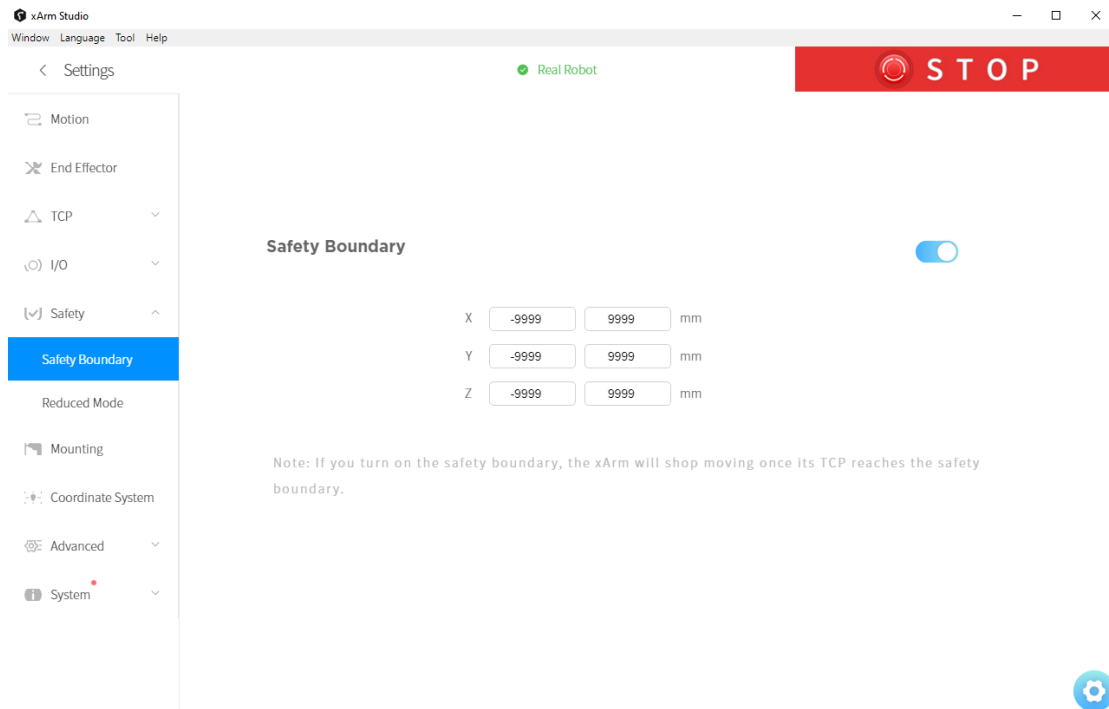

Safety Boundary

- When this mode is turned on, the working range of the robotic arm in Cartesian space can be limited. If the tool center point (TCP) of the robotic arm exceeds the set safety boundary, the robotic arm will stop moving. The user can then adjust the robotic arm back into the restricted space.

1.4.5.2 Reduced Mode

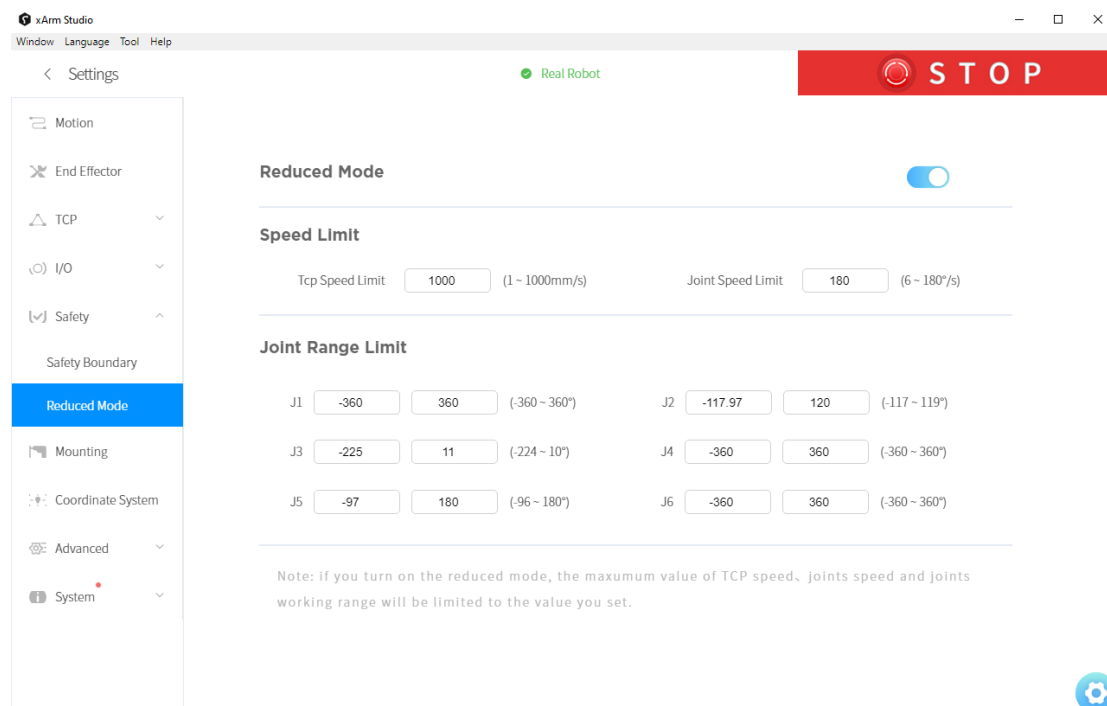

Reduced Mode

- When this mode is turned on, the maximum linear speed, maximum joint speed, and joint range of the robotic arm in Cartesian space will be limited.

1.4.6 Mounting

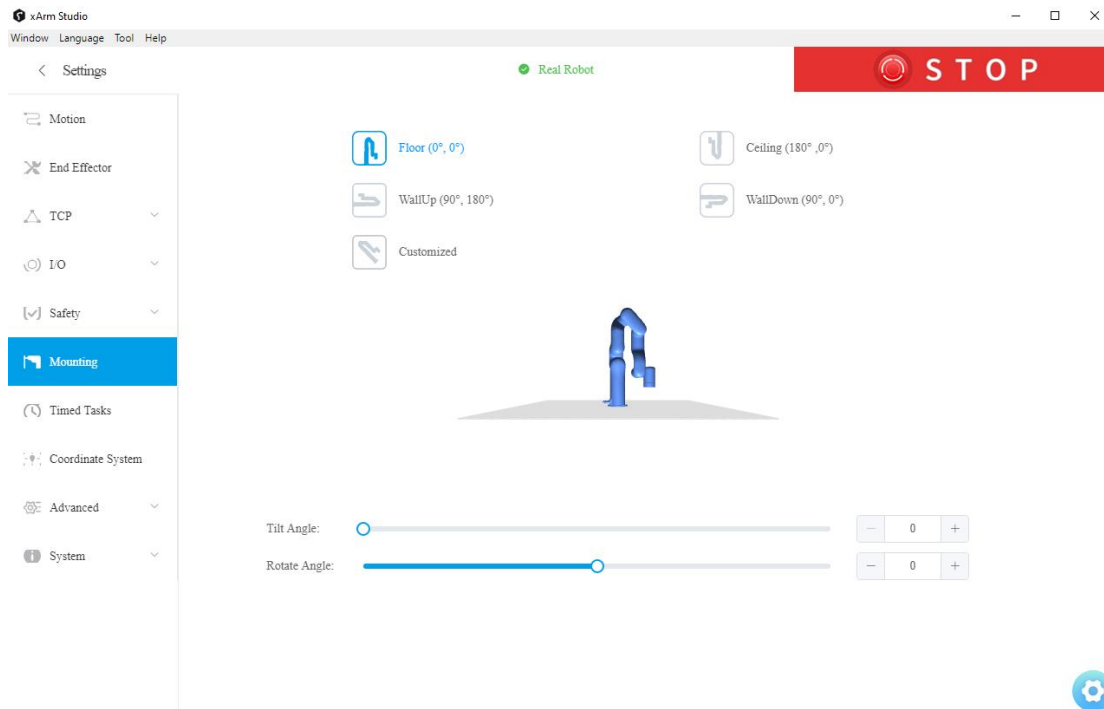

Setting the mounting direction of the robotic arm is mainly to inform the control box of the current relationship between the actual mounting direction of the robotic arm and the direction of gravity. If the mounting direction of the robotic arm is set incorrectly, the robotic arm will not be able to accurately recognize the direction of gravity, which will cause the robotic arm to frequently trigger a collision warning and stop motion, and will also result in uncontrolled motion of the robotic arm after entering manual mode.

【Floor (0 °, 0 °)】

- The default method is horizontal installation, and the horizontally mounted robotic arm does not need a tilt angle and a rotation angle.

【Ceiling (180 °, 0 °)】

- For ceiling-mount, users simply need to set the mounting method as ceiling, and it is not necessary to set the angle of rotation.

【WallUp (90 °, 180 °)】

- Indicates that the robotic arm is wall-mounted and the end of the robotic arm is facing up.

【WallDown (90 °, 0 °)】

- Indicates that the robotic arm is wall-mounted and the end of the robotic arm is facing down.

【Customized】

- Mount at other angles. For mounting at a certain angle. It is necessary to set the tilt angle and the rotation angle according to the actual situation.

How to determine the tilt angle and rotation angle?

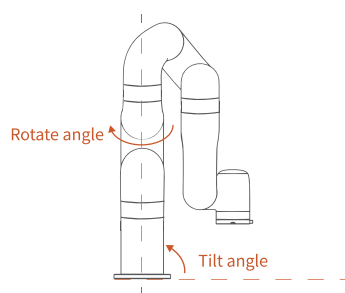

The initial position of the robotic arm:

- On the horizontal plane, when the user is facing the robotic arm side, the initial position is on the left-hand side of the user in a downward

direction.

Tilt angle: The initial position of the robotic arm and the base of the robotic arm to be mounted should be in a tilt angle, which ranges from 0 to 180°.

Rotation angle: The initial position of the robotic arm and the end direction of the robotic arm to be mounted should be used as the rotation angle.

The method of determining the rotation angle \pm direction:

Hold it with your right hand and point your thumb in the direction of the robotic arm which is vertically mounted. The direction where your four fingers point is the positive direction and vice versa.

The range of rotation angle : $\pm 180^\circ$

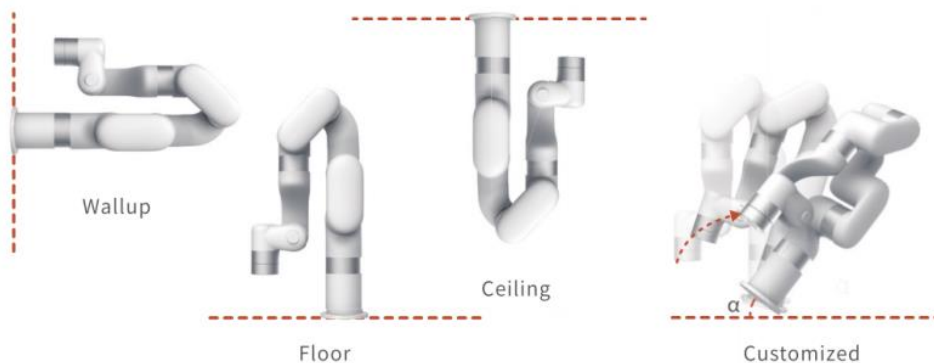



DANGER

Make sure the robotic arm is properly placed according to the actual use.

Must be mounted on a sturdy, shock-resistant surface to avoid the risk of rollover of the robotic arm.

1.4.7 Timed Tasks

Timed tasks can schedule the offline task to run at a specific time or within a time range in the future, without the need for an I/O triggering signal. When using this function, please ensure the safety of the equipment and personnel around the robotic arm within the timed range.

The screenshot shows the 'xArm Studio' interface with the 'Timed Tasks' section active. At the top right, there is a red 'STOP' button. Below it, the 'Timing Task | Periodic Task' configuration is visible. The 'System date time' is 2020-05-08 09:49:25, and there is a 'Calibration' button. A table lists tasks with columns for Task name, Start time, End time, and operation.

Task name	Start time	End time	operation
739950	2019-11-28 16:48:44	2019-12-28 16:45:50	expired
553238	2020-05-14 00:00:00	2020-05-15 00:00:00	unactivated

Below the table, the 'Task name: 553238' is shown with 'Totals: (1)' and an 'Add' button. A dropdown menu shows '[Blockly] 1001-Lin'. At the bottom, there are 'New' and 'Select' buttons, and a gear icon for settings.

【Timing Task】 : The robotic arm will run the added tasks during the timing range within the set effective time according to

the system time of the control box.

【Periodic Task】 : The robotic arm will periodically run the added tasks during the timing range within the set effective time according to the system time of the control box.

【Calibration】 : Calibrate the system time of the control box according to the time of the connected computer.

【New】 : Create a new task project, under which the user can **【Add】** several Blockly and Python tasks.

【Select】 : Select the tasks to **【Cancel】** .

【Inactivated】 : Inactive projects will not take effect during the effective time.

【Activated】 : Activated projects will take effect within the effective time, and the robotic arm will automatically run the tasks within the set time.

【Expired】 : The set time for the project has expired

【✘】 : Delete the tasks added under the project.

1.4.8 Coordinate System

The screenshot shows the 'Coordinate System Settings' window in xArm Studio. The interface includes a sidebar with navigation options like Motion, End Effector, TCP, I/O, Safety, Mounting, Timed Tasks, Coordinate System (selected), Advanced, and System. The main area displays three coordinate system configurations:

- Current Coordinate System:** X: 0 mm, Y: 0 mm, Z: 0 mm, Roll: 0°, Pitch: 0°, Yaw: 0°
- No offset:** (Default) X: 0 mm, Y: 0 mm, Z: 0 mm, Roll: 0°, Pitch: 0°, Yaw: 0°
- upside_down:** (Set as Default) X: 200 mm, Y: 0 mm, Z: 1000 mm, Roll: 180°, Pitch: 0°, Yaw: 0°

Below the settings, a diagram illustrates the coordinate systems. 'A: Base coordinate system' is centered at the robot's base, and 'B: Tool coordinate system' is centered at the end effector. The axes are labeled X, Y, and Z.

In this interface, the user can set the coordinate offset to customize the user coordinate system. X, Y, Z are coordinate values that are offset relative to the base coordinate system. Roll, Pitch, Yaw represents the angular values of orientation relative to the base coordinate system. After this offset setting, user coordinate system becomes the world origin instead of robot base.

【New】 : Create a new user coordinate offset.

【Select】 : Select the data to be deleted.

【Set as Default】 : Set the offset data as the default offset.

【Default】 : The data is the default current base coordinate offset.

【Cancel】 : Cancel the selection.

【Save】 : Save the modified data.

【Discard】 : Discard the modified data.

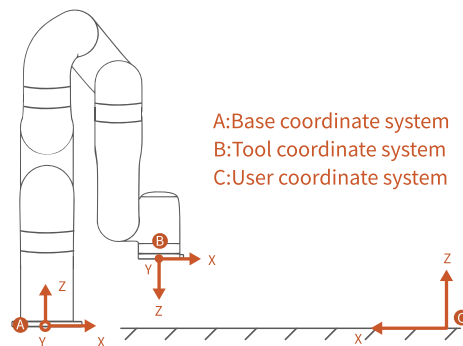

Example:

When expressed in coordinate system {A}:

B is (207,0,112,180,0,0) , $D_{AC} = 1000\text{mm}$, if user want to set the world reference coordinate system to {C}, just express the position and orientation of user coordinate system {C} in coordinate system {A}.

As figure shown, the offset of the base coordinate system should be (1000,0,0,0,0,180).

Former TCP coordinates of B (207,0,112,180,0,0) in base coordinate system, after user coordinate system offset setting:

Becomes: B ' (793,0,112,180,0,180)

1.4.9 Advanced Settings

1.4.9.1. Advanced Parameters

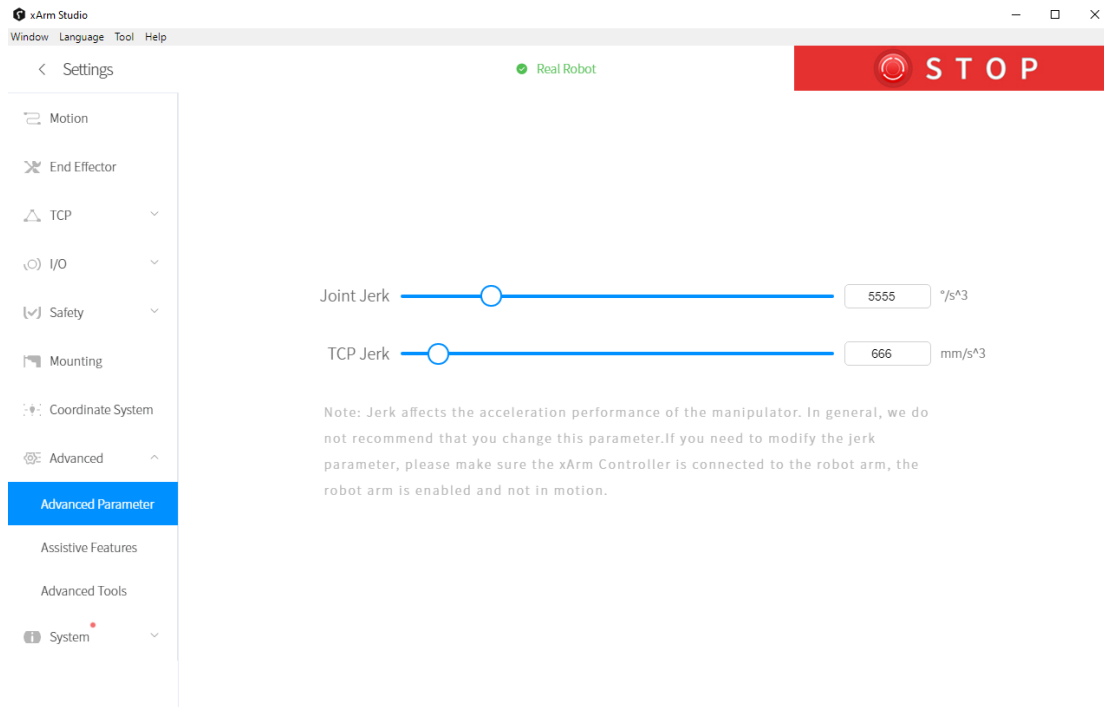

If you want to modify the joint jerk and TCP jerk of the robotic arm, you can modify time here.

Note:

1. The jerk affects the acceleration performance of the robotic arm. In general, we do not recommend modifying this parameter.
2. If the robotic arm is not enabled, the jerk cannot be modified.
3. If an error warning occurs on the robotic arm, the jerk cannot be modified.

4. When the robotic arm is moving, the jerk can not be modified.

1.4.9.2. Assistive Features

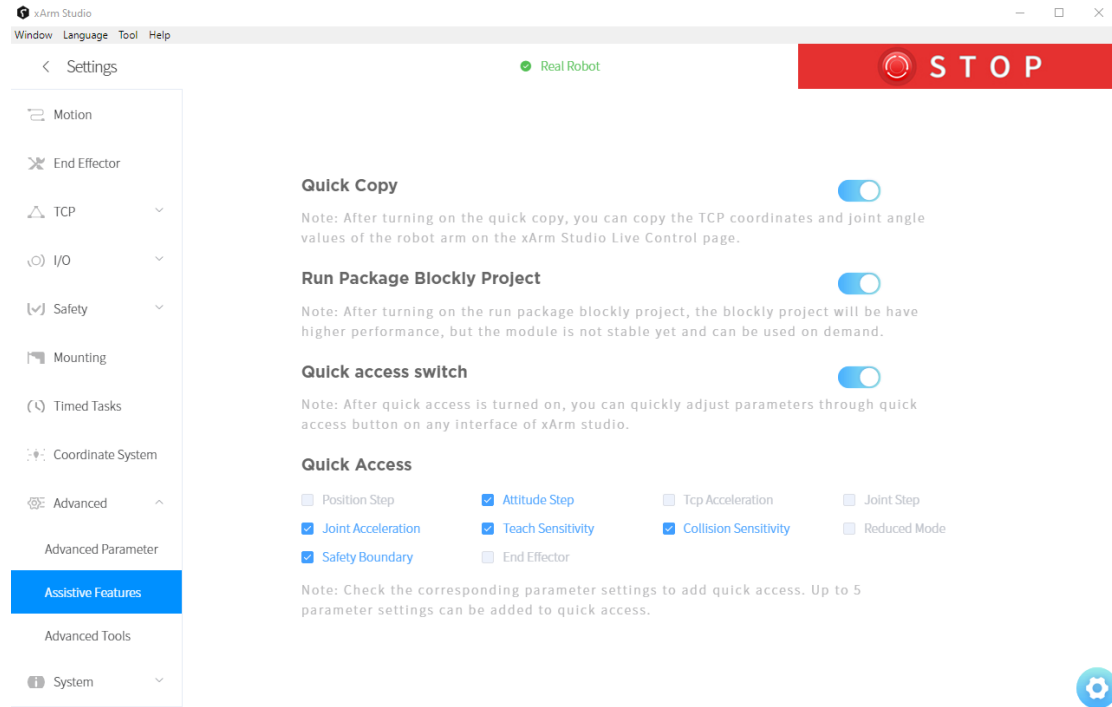

Quick Setting

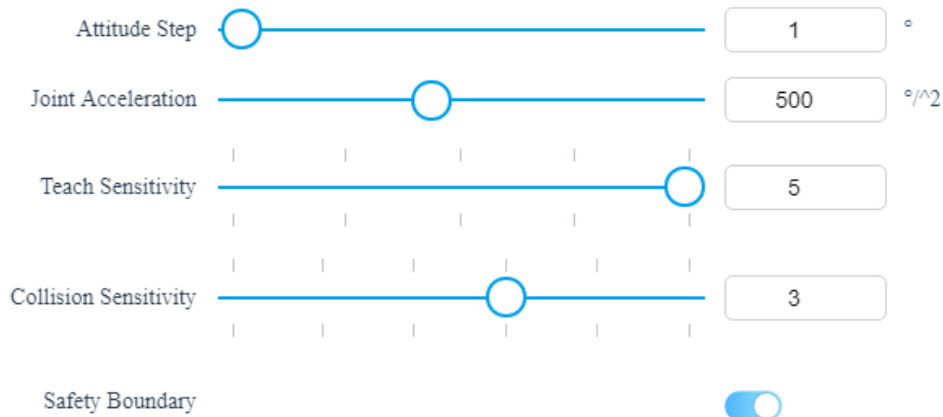

【Quick Copy】

- After turning on this button, the TCP coordinates and joint angle

values of the xArm can be copied on the real-time control interface.

【Run Package Blockly Project】

- Run Package Blockly Project can avoid the Blockly program from being affected by the network communication between the client and the control box during the running process, which improves the running speed of the program.

Note: After turning on this button, the Blockly program will not be interrupted after closing the client terminal and will continue to run, so please do a security assessment before using this function.

【Quick access button】

-  After opening this button, the 【Quick setting】 interface will pop up. In this interface, you can quickly adjust the value of each parameter.

【Quick access switch】

- After enabling quick access, you can quickly adjust parameters through the 【Quick access button】 in any interface of xArm Studio.

【Quick access】

- You can select the parameters you want to access quickly, and the selected parameters will be displayed on the quick setting interface.

1.4.9.3. Advanced Tools

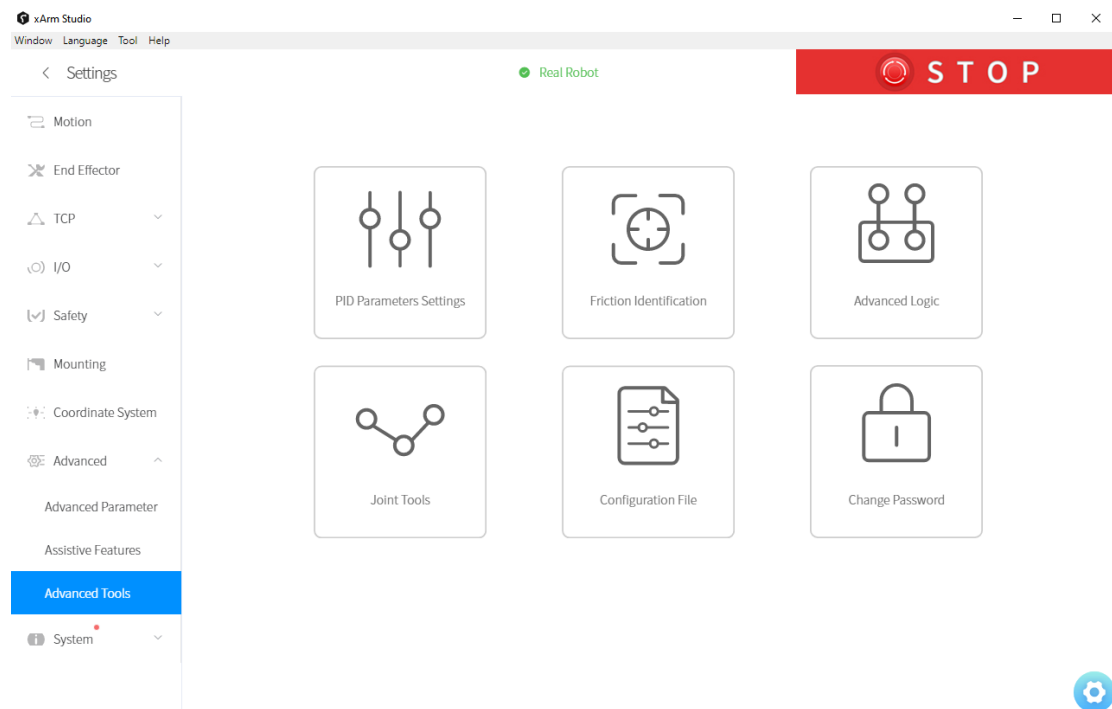

PID Parameters Settings

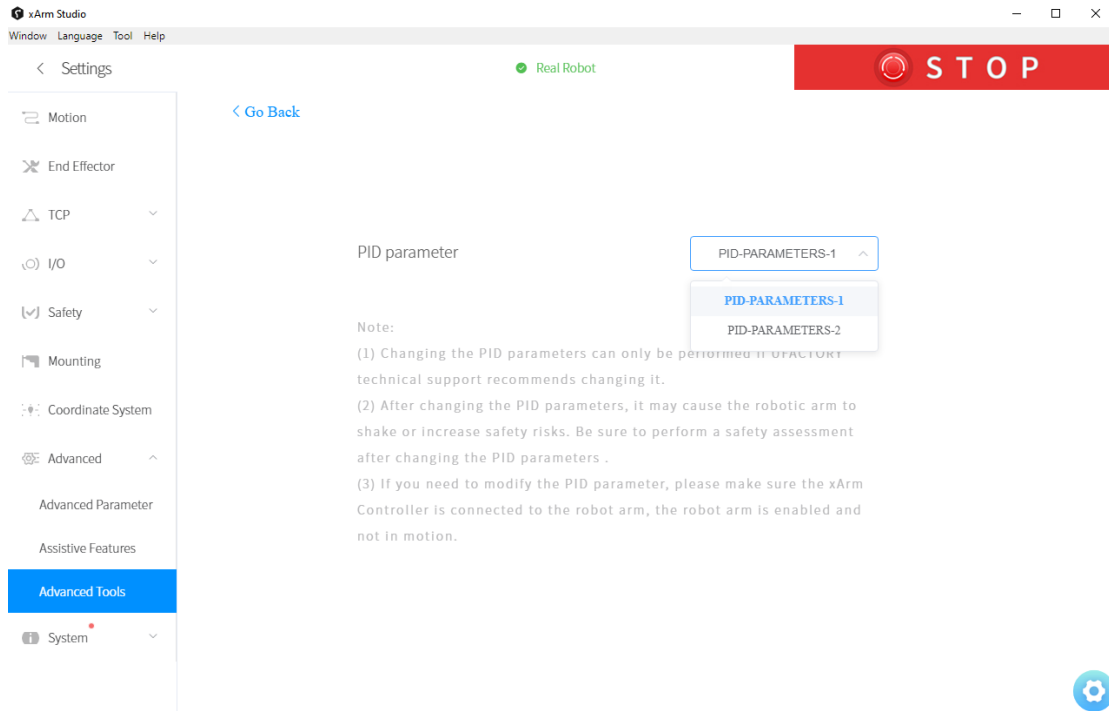

Steps for changing PID parameter:

1. Select PID-PARAMETERS-1 (or PID-PARAMETERS-2).
2. Then click [Save].

In the following cases, the PID parameters cannot be modified:

1. If the robotic arm is not enabled, the PID parameters cannot be modified.
2. If an error warning occurs on the robotic arm, the PID parameters cannot be modified.
3. When the robotic arm is moving, PID parameters cannot be modified.

The following situation can be improved by modifying the PID

parameter:

1. If the robotic arm shakes heavily executing motions with payload.

Note:

1. Changing The PID parameter can only be performed if UFACTORY technical support recommends changing the PID parameters. (contact technical support: support@ufactory.cc)
2. After changing the PID parameters, it may cause the robotic arm to shake or increase safety risk. Please be sure to perform a safety assessment after changing the PID parameter.

Friction Identification

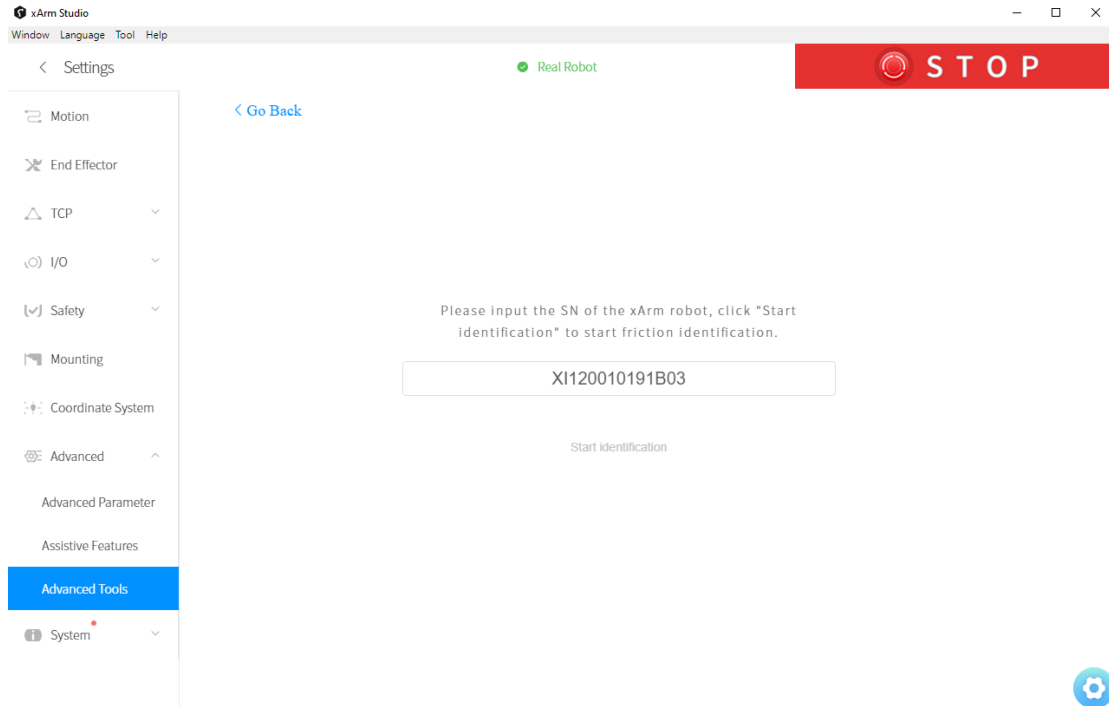

Tips

(2) The bound controller of the xArm robot is replaced.
(3) The UFACTORY technicians recommend you to do friction identification.

Before friction identification, you need to ensure all the following conditions are met:

- (1) No workpiece or end effector is installed at the end of the robot arm.
- (2) The robot arm is mounted horizontally.
- (3) There are no obstacles in the space of 1m * 1m * 1m above the mounting plane of the robot arm.
- (4) The collision sensitivity of the robot arm has been set to 0.
- (5) The TCP payload of the robot arm have been set to 0.

I have read and understand all the above information.

When the robotic arm needs friction identification, please input the SN of the robotic arm base for friction identification.

The following situation can be improved by modifying the friction identification:

1. If manual mode or collision detection performance is far from

satisfying.

Note: Before friction identification, please read the software tips carefully and strictly follow the software guidelines for friction identification.

Advanced Logic

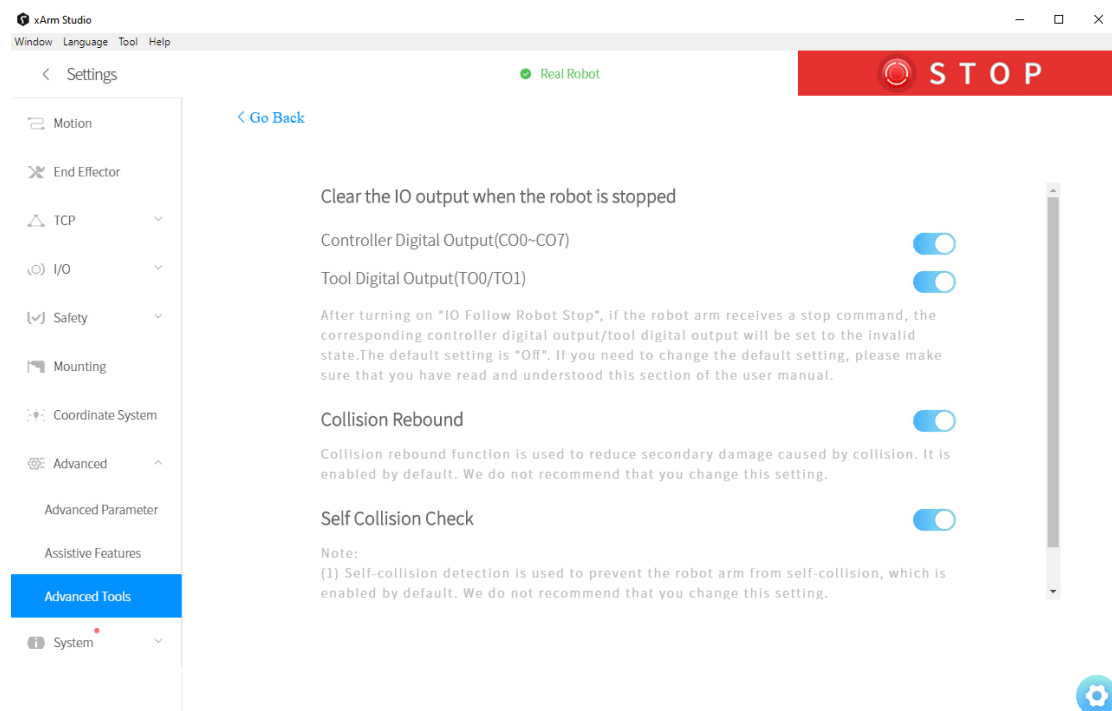

Clear the IO output when the robot is stopped

After turning on **【Clear IO output when the robot is stopped】** if the robotic arm receives a stop command, **【Controller Digital Output】** or **【Tool Digital Output】** will be set to the invalid state. Otherwise, the **【Controller Digital Output】** or **【Tool Digital Output】** will not be affected by the stop command.

Collision Rebound

- When this mode is turned on, the robotic arm will rebound backward for a certain distance after it collides with an obstacle. If collision sensitivity is not zero, when this mode is turned off, the robotic arm will stay at the position where collision is detected.

Self-collision detection

- When the mode is turned on, it will prevent the xArm from causing self-collision.

Joint Tools

1. Joint Status

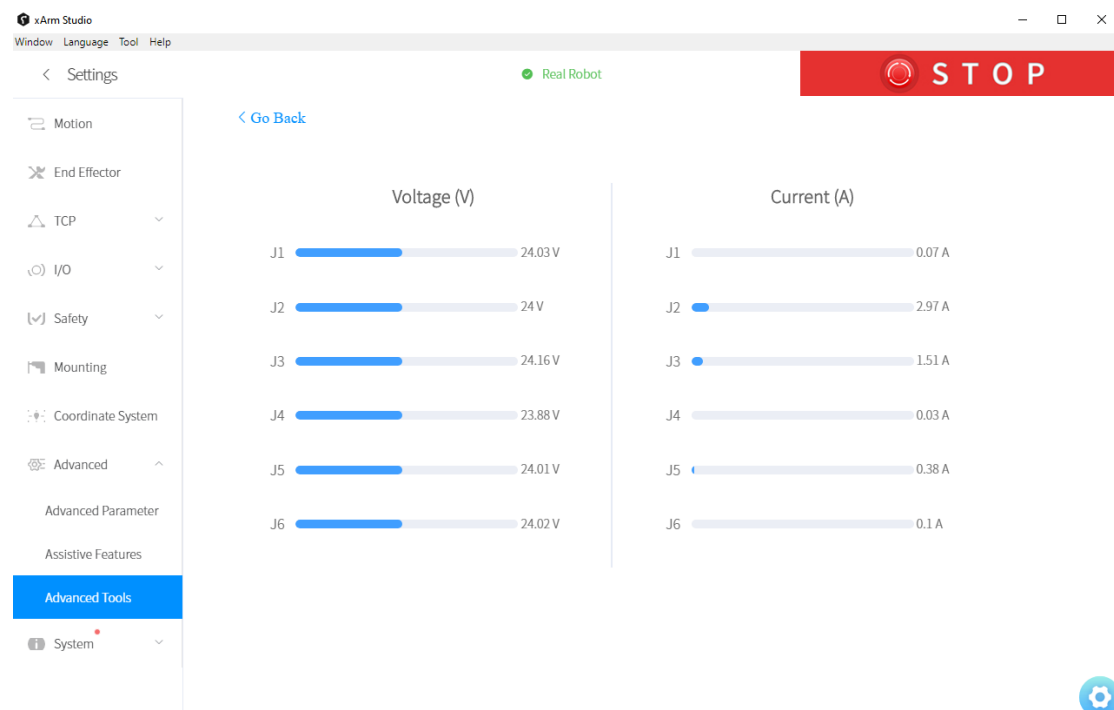

In this interface, you can get the joint current value and joint voltage

value of the robotic arm.

The range of the joint voltage value of the robotic arm is: [0, 50V]

The range of the joint current value of the robotic arm is: [0, 35A]

Note: When using the above functions, the joint firmware version \geq 2.7.0.

2. Unlock Joints

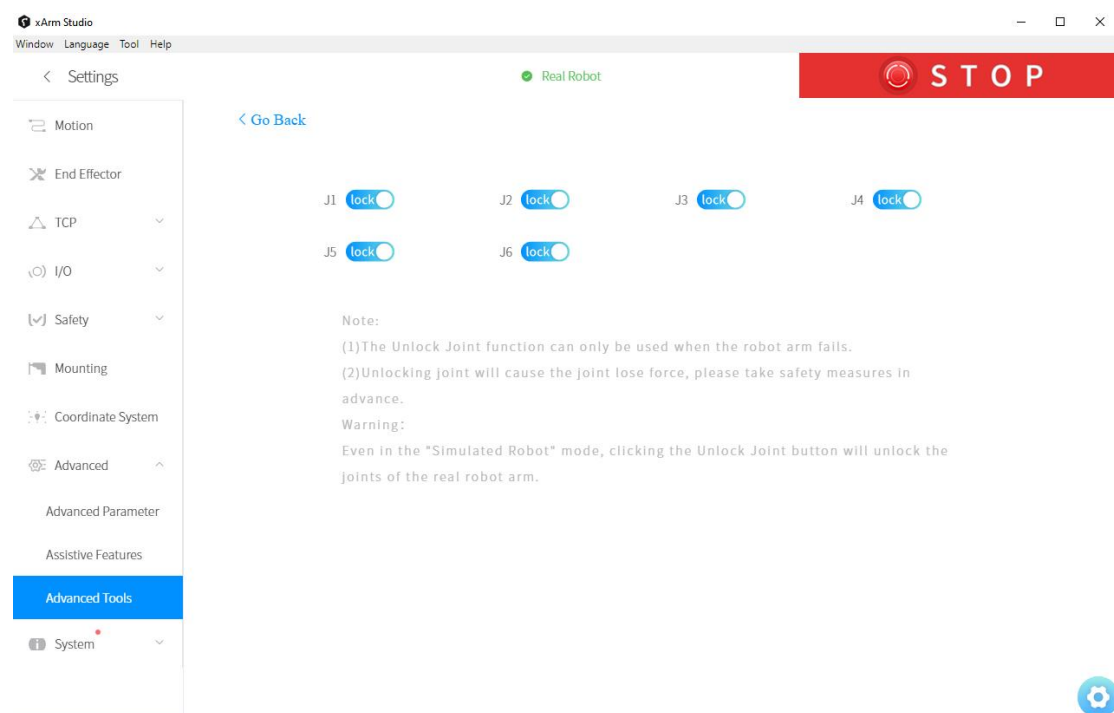

Click **【lock】** to unlock a single joint. The unlocked joint does not have any force to provide and thence external force support is needed. At this time, the joint can be dragged by hand to rotate. After confirming the position, please re-lock all the joints manually.

Note:

1. Please ensure to hold the robotic arm by hand when unlocking the

joint to prevent it from falling down due to the inadequate provision of force, and take measures to protect the surrounding environment and peripheral facilities.

2. The operation of the unlocking joint is mainly used to adjust the posture of the robotic arm to a relatively safe position when the error is reported by the robotic arm. Attention should be paid to adjusting the joint into the range manually when it exceeds the range of the joint.

3. In the "simulated robotic arm mode", clicking the unlock joint button will also unlock the real joints of the robotic arm.



DANGER

When releasing the joint brakes, someone must support the robot's posture to prevent the robotic arm from falling without external force and damage the robotic arm and surrounding equipment.



CAUTION

After the release of the joint brake and manually dragging the robotic arm, please always pay attention to the degree of joint rotation to avoid exceeding the rotation range of the robot joint and damage the internal structure of the robotic arm.

3. Multiturn-Encoder Error Clear

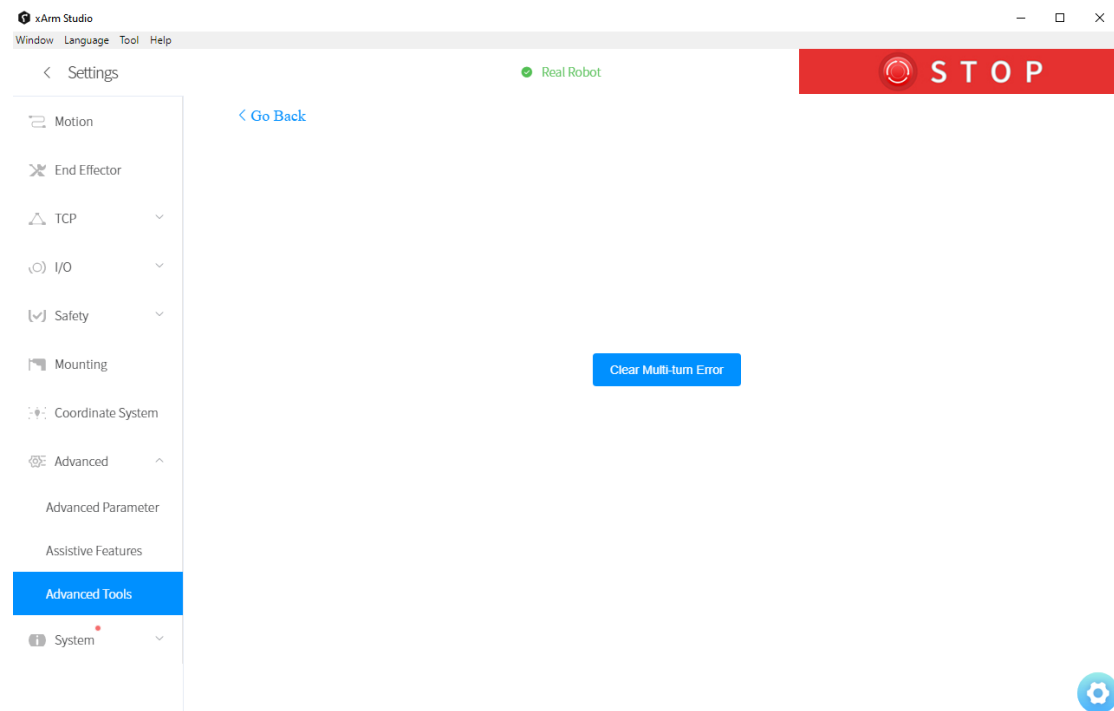

When the control box reports "multi-turn encoder error", please use this tool to clear the error.

Configuration File

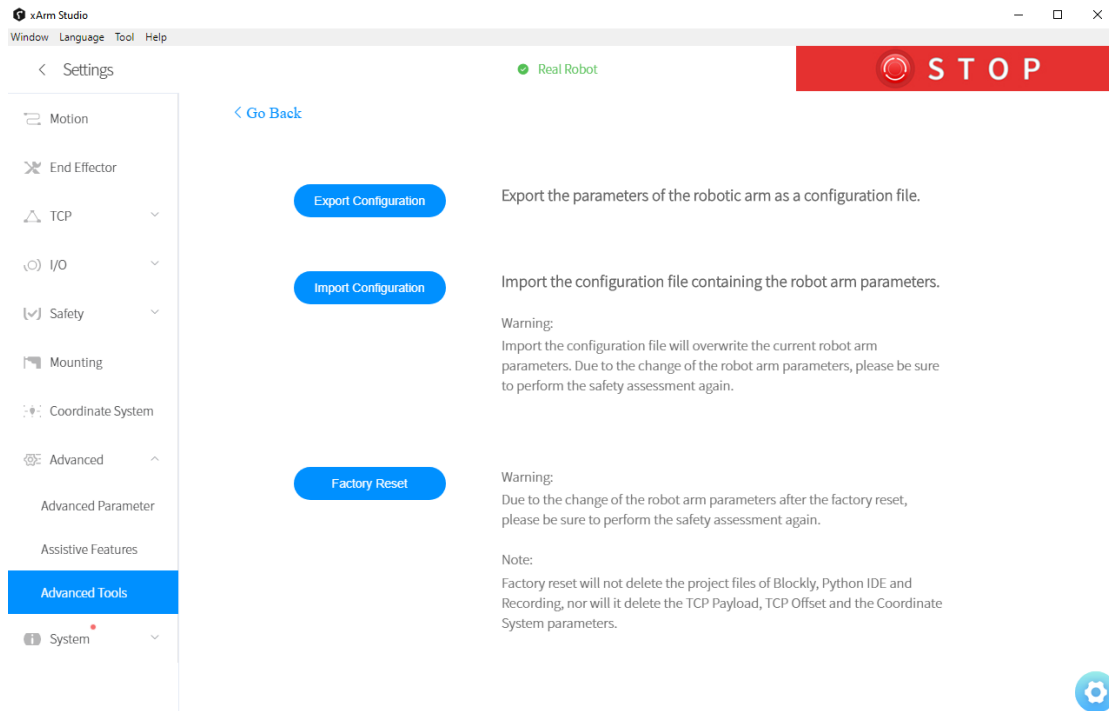

1. Click the **【Export Configuration】** button to export the parameters of the robotic arm as a configuration file.

The robotic arm parameters that can be exported mainly include: motion parameters, TCP offset, TCP payload, IO settings, safety boundary, installation methods, coordinate systems, and advanced parameters.

2. Click the **【Import Configuration】** button to import the configuration file containing the parameters of the robotic arm.

3. Click the **【Factory Reset】** button, and the robotic arm will restore the factory settings mode.

Note:

(1) When multiple robotic arms need to share a set of configuration parameters, click the **【Export Configuration】** button to export the configuration file of a robotic arm that has been set. Then click the **【Import Configuration】** button to import the configuration file to other robotic arms.

(2) When the control box fails and needs to be repaired, you can export and save the configuration file of the robotic arm to prevent the original data from being lost or changed during the repair process.

(3) The parameters of the robotic arm will change after the factory reset. Please export the configuration file of the robotic arm before the factory reset.

Change Password

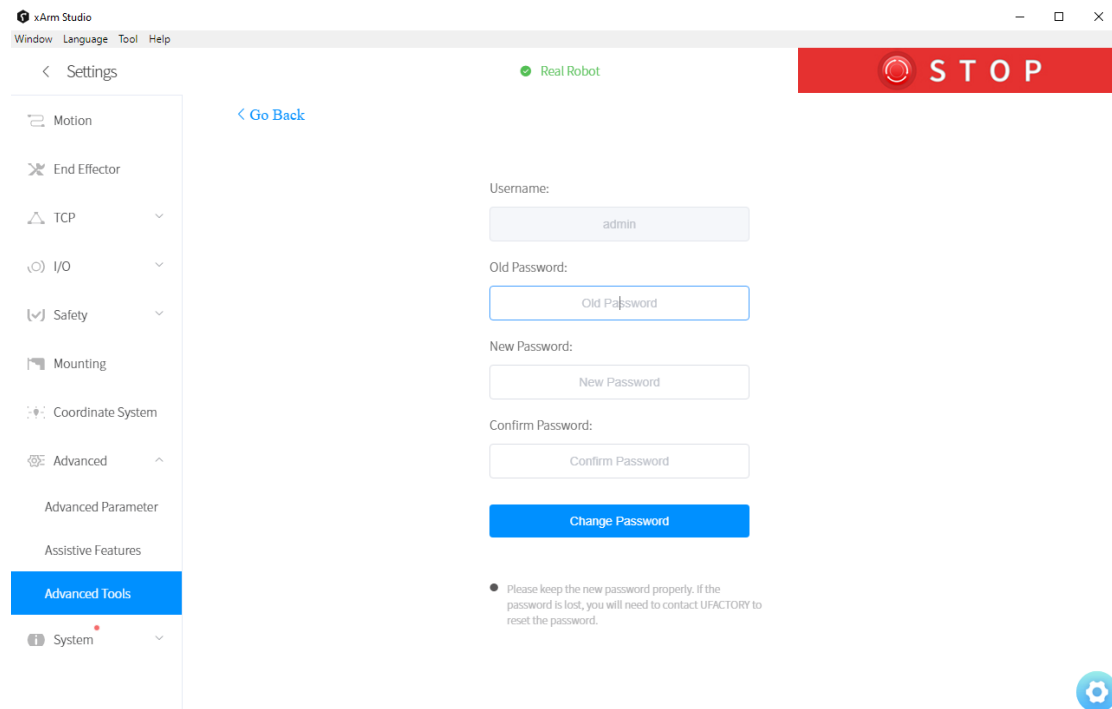

The user password of the Advanced Tools can be modified in the page shown above.

Note: Please keep the new password properly. If the password is lost, you will need to contact UFACTORY to reset the password.

1.4.10 System Settings

System Settings mainly include Check Update, System Information, Network Settings, and Log.

Check Update

- Software updates for xArm Studio, and firmware updates for the robotic arm.

System Information

- Display the IP address of the connected robotic arm, the firmware version of the arm, and the xArm Studio software version.

Network Settings

- Display the IP address of the robotic arm, subnet mask, broadcast address, and default gateway. The DNS address can be modified and added.

Log

- Display or Download the error log of the robotic arm.

1.4.10.1 System Information

Device information 	
Robot Axis :	6
Device Type :	6
Device Address :	192.168.1.135
Firmware Version :	1.4.11
Robot SN :	XI110009191B02
Studio information	
Version :	1.4.7

On the page of System Information, the control box can be rebooted or the joint can be operated, the degree of freedom(number of axis) of the current robotic arm, IP address, firmware version, SN address, and

software version of the robotic arm can be checked.

Control Box shutdown / Reboot:



Access to Control Box Shutdown

- Access to **【Settings】 - 【System Settings】 - 【System Information**
🔴]

Shutdown / Reboot

The control box can be shut down or restarted. Note that the shutdown / reboot button does not turn off the power supply and the main power supply to the robotic arm.

【xArm Shutdown】

- Click this button, the page will go back to the **【Search the IP Address of the Control Box】** page, and the control box will shut down. This operation is equivalent to long pressing the Power button of the control box, and the shutdown process takes 2 to 3 seconds.

【xArm reboot】

- Click this button, the control box of the robotic arm will restart. After

the restart action is completed, the pop-up window will close and the robotic arm will be automatically reconnected. The operation is equivalent to the shutdown and startup process of the control box, and restart process takes 3 to 4 seconds.

Note: The 【xArm shutdown】 and 【xArm Reboot】 buttons do not affect the main power supply of the control box and the power supply of the robotic arm.

1.4.10.2 Software / Firmware Update

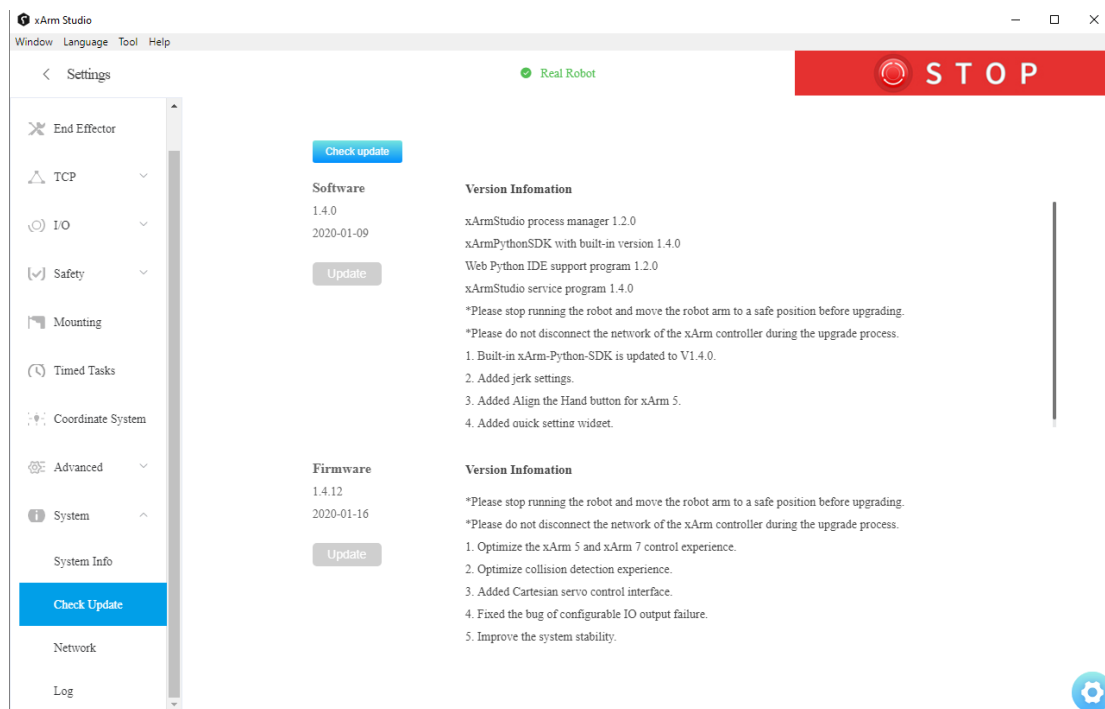

When updating software and firmware, make sure that the local area network where the computer and control box are located can

communicate with the external network. In addition, make sure the control box can communicate with external internet.

Check update : Click this button to check whether the control box is connected to the Internet.

Note:

Note: For detailed steps on updating xArm Studio and xArm firmware, please refer to [Appendix 4-xArm Software/Firmware Update Method](#).

1.4.10.3 Network Settings

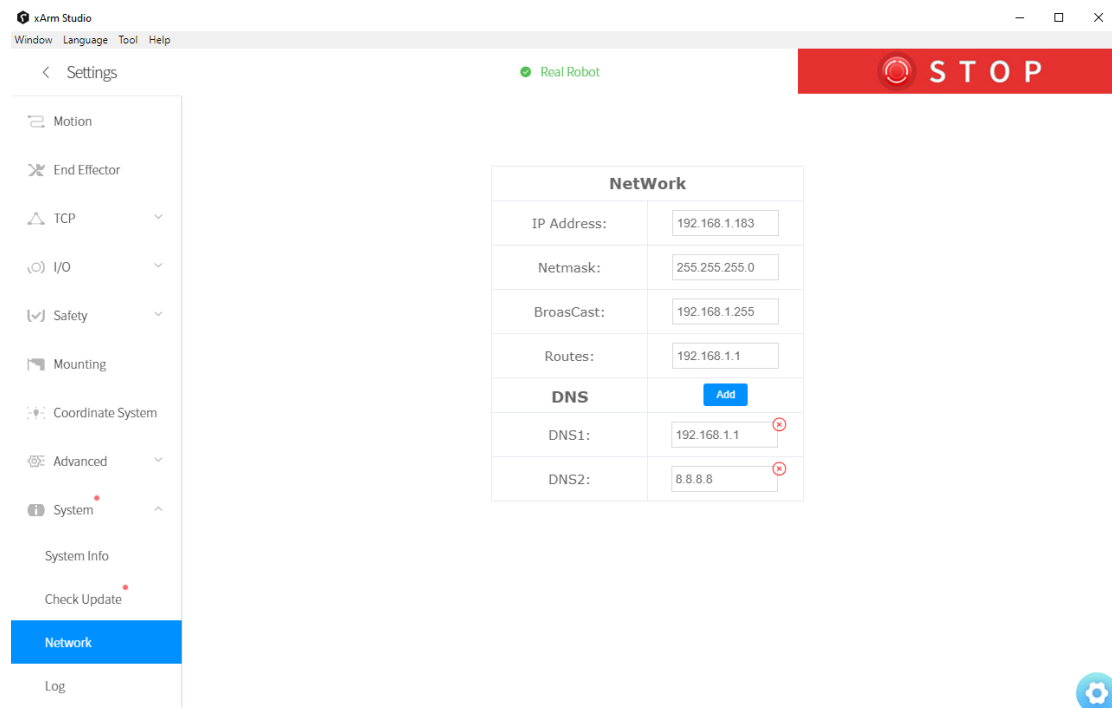

The IP address, subnet mask, broadcast address, and default gateway of the control box of the robotic arm are displayed on this page. You can

change the IP address of the control box and add DNS.

Note:

If you change the IP address, be sure to mark it on the control box. If you forget or lose the modified IP address, you can use the following method to reset the IP.

Reset IP

Steps to reset IP:

1. Press the emergency stop button and turn off the power of the control box.
2. Connect RI0 to GND with a cable.

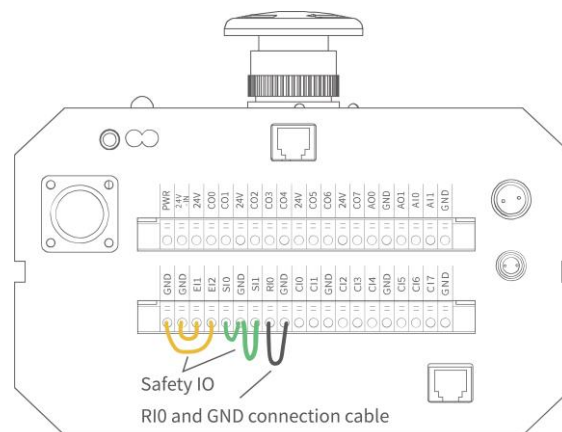

3. Turn on the power of the control box. After hearing the sound of "beep", it means that the IP address of the control box has been reset successfully. The reset IP is 192.168.1.111.

4. Please unplug the cable connecting RI0 and GND and wait for the control box to start up (60 seconds).
5. Enter 192.168.1.111 in the xArm Studio search box, connect the robotic arm.

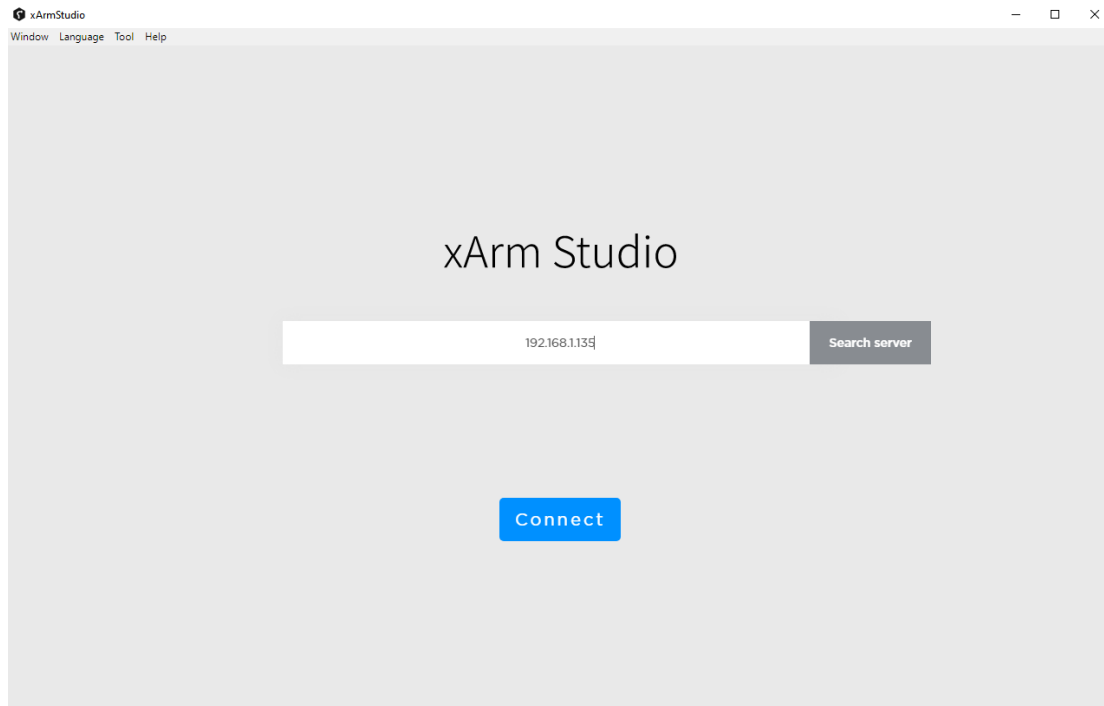

6. If you need to modify the IP, just modify the IP in [Settings] → [System Settings] → [Network Settings].(For example: the modified IP is 192.168.1.135)

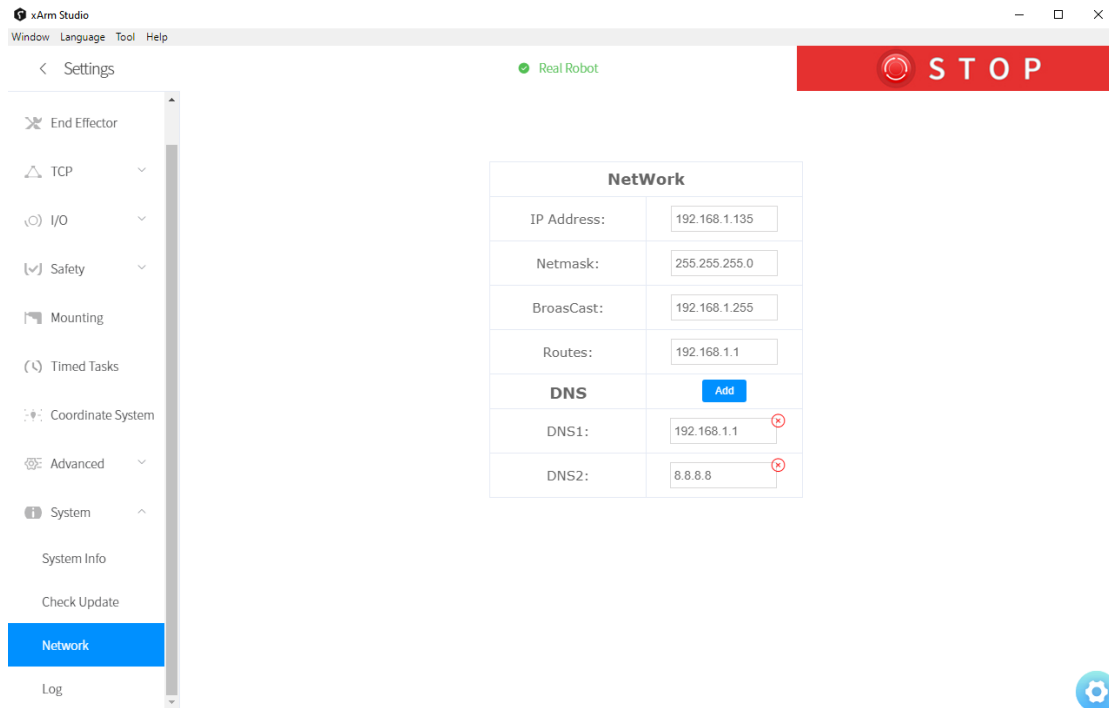

7. Restart the control box, enter your modified IP in the xArm Studio search box, and connect the robotic arm.

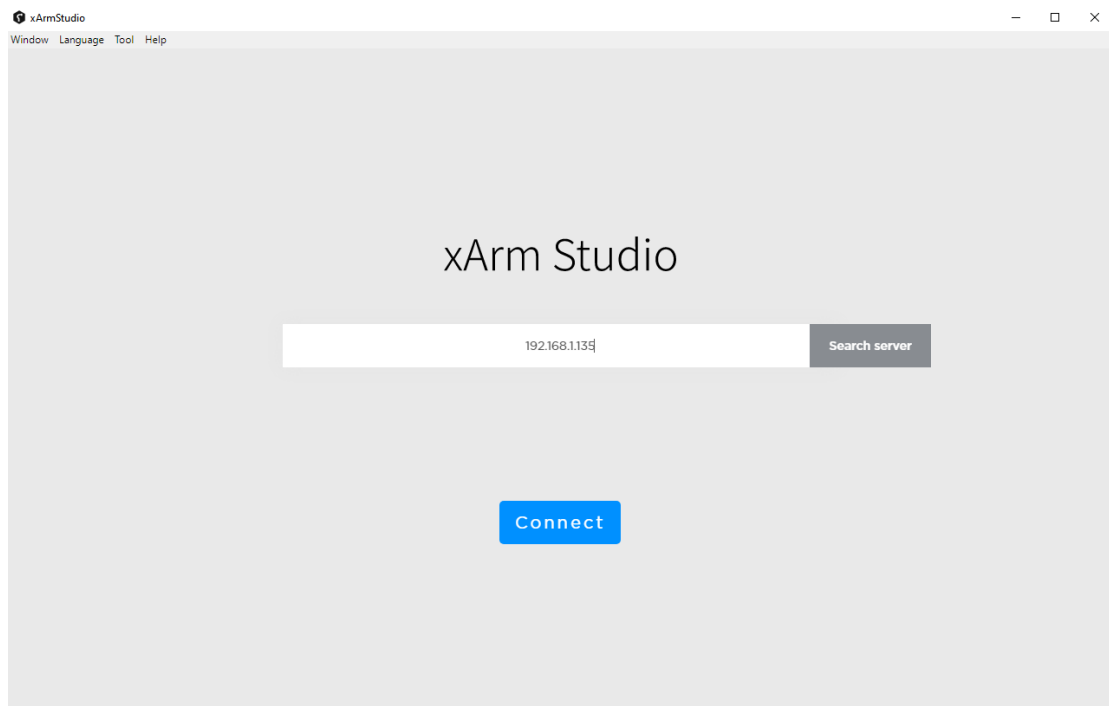

Note:

1. If you need to reset the IP, the xArm firmware version must be \geq V1.5.0.
2. If you do not unplug the cable connecting RIO and GND, the next time you restart the control box, no matter what IP address you modify, the IP address of the control box will be automatically changed to 192.168.1.111, so after modifying the IP, Be sure to unplug the cable connecting RIO and GND.

1.4.10.4 Log

The error log of the control box can be checked.

Click the **【Download】** button to download the error log.

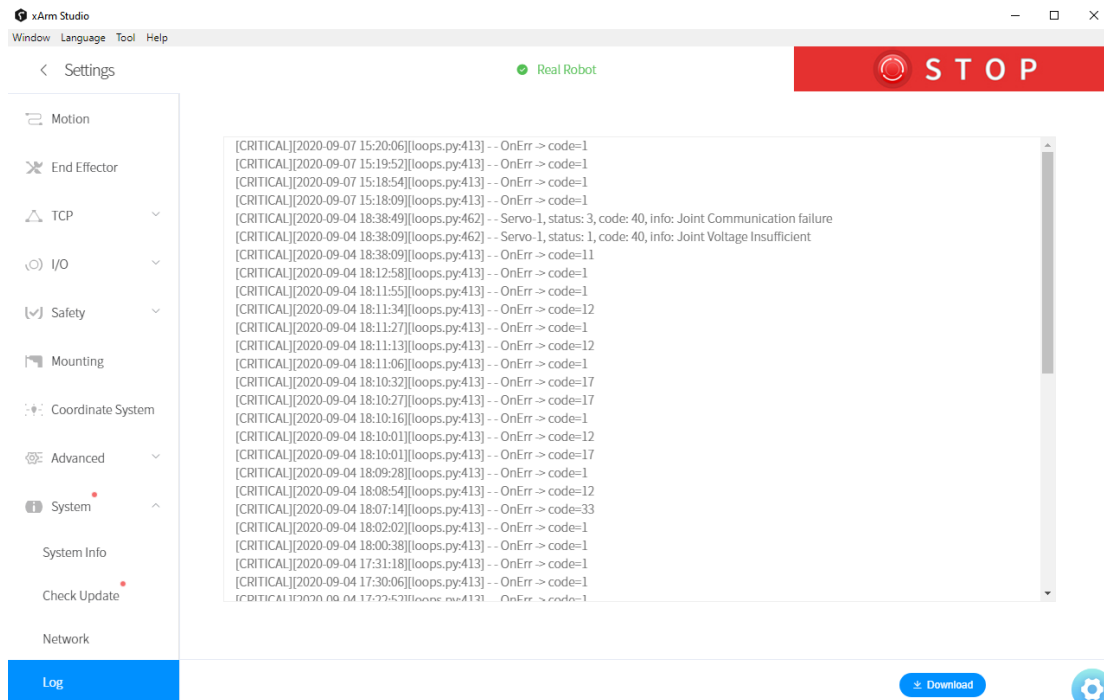

1.5 Live Control

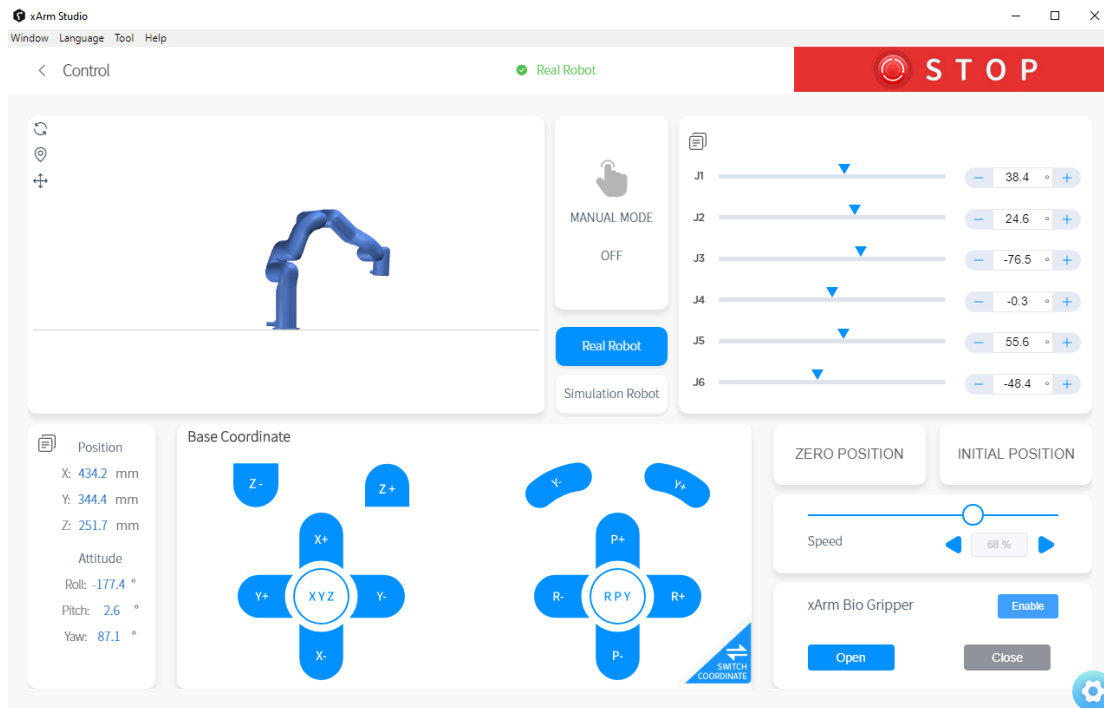

1.5.1 Status Bar

The "unconnected robotic arm" indicates that the robotic arm is not connected. Please reconnect the robotic arm on the homepage. If it is not connected, please check if the robotic arm is normally turned on and check if the network connection is normal.

Simulate Robot

The "Simulate Robot" indicates that the robotic arm is connected and is currently in simulation mode. In this mode only, the joint motion of the simulated robotic arm can be controlled by the live control panel.

Real Robot

The “Real Robot” indicates that the robotic arm is connected. It is currently a real robotic arm, and all control functions on the live control panel are available.

1.5.2 Emergency Stop



Click on the emergency stop button to immediately stop the current motion and clear all cached commands.

Note:

The “STOP” button in xArm Studio is different from the one on the control box.

1. The “STOP” button in xArm Studio allows the robotic arm to stop the current motion and clear all cache commands immediately. It is a software stop, and the power is still on.
2. The Emergency STOP button on the control box: Send out a stop command to cut off the power supply of the robotic arm, and thence the posture of the robotic arm will slightly brake and fall.

1.5.3 Real Robot/ Simulation Robot

【Real Robot】

- It can control the motion of the real robotic arm in the interface of

xArm Studio, and the virtual robotic arm will reflect the position and posture of the real robotic arm in real-time.

【Simulation Robot】

- It can control the motion of the virtual robotic arm in the interface of xArm Studio.

Note: A robotic arm can only be in one mode (Real Robot Mode/Simulation Robot Mode).

【】 : It can reload the entire software control interface and refresh the model posture.

1.5.4 Manual Mode

By turning on the Manual Mode, the joint can be driven freely by hand.

- Turn on the joint manual mode, you can manually drag the robot links to reach the target position, making it easier to record the robot's motion trajectory, thereby reducing the development workload. When danger occurs, you can also use the manual mode to manually drag the robot away from the danger zone.
- Drag sensitivity can be set in 【Settings】 - 【Motion Settings】 - 【Teach sensitivity】 .

Note:

1. Before opening the manual mode, you must ensure that the installation method of the robotic arm and the payload setting of the robotic arm are consistent with the actual situation, otherwise

it will be dangerous.

2. The serial number of robotic arm and the control box need to be matched before Manual Mode can be turned on. The SN of the control box can be checked in **【Settings】 - 【System Information】** .
3. The SN address of the robotic arm can be checked next to the power signal interface of the base.

1.5.5 Joint Motion

The robotic arm consists of joint modules. The position of the end-effector is controlled by coordinating the rotation angle of each joint.

The joint motion reaches the target point with the fastest path, the end trajectory is not a straight line, and the speed unit is °/s. After the target point is set, the corresponding poses are unique for TCP and the joints along the trajectory.

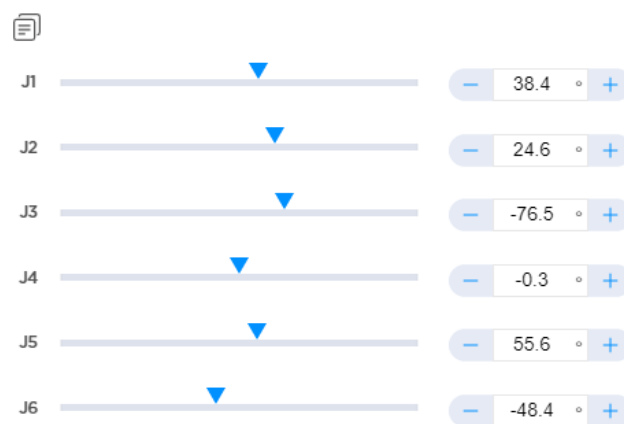



You can copy the joint angle value of the robotic arm by clicking this button.



The progress bar represents the range of joints, the text represents the current joint and its degree.

Operation mode:

Click **【+】** or **【-】** for the step angles, users can set the step angle in **【Settings】 - 【Motion Settings】 - 【Joint Motion】 - 【Joint Step】** .

Press-and-hold **【+】** or **【-】** for continuous joint motion in a positive or negative direction, which will stop when the mouse is released.

To confirm the direction of joint rotation, please refer the figure

below:

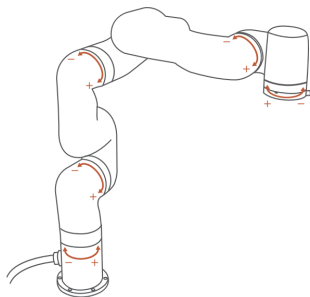

xArm 5

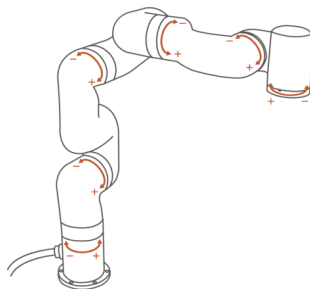

xArm 6

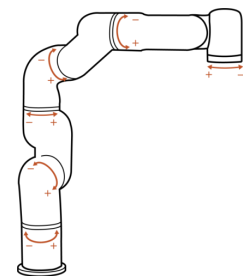

xArm 7

1.5.6 Linear Motion

1.5.6.1 Introduction

Users can control the motion of the robotic arm based on the base

coordinate system and TCP coordinate system. The trajectory of tool center point in the Cartesian space is a straight line. Each joint performs a more complex movement to keep the tool in a straight path. The TCP path is unique once the target point is confirmed, and the corresponding posture in the execution process is random.

X, Y, and Z control the position of TCP in base or tool coordinate system, in the unit of mm. While Roll/Pitch/Yaw controls the TCP orientation in the unit of degree.

Linear motion and arc linear motion belong to the Cartesian space trajectory planning, which needs to be solved by inverse kinematics. Therefore, there may be no solution, multiple solutions, and approximated solutions; and due to the nonlinear relationship between the joint space and Cartesian space, the joint motion may exceed its maximum speed and acceleration limits.

1.5.6.2 TCP Coordinate System

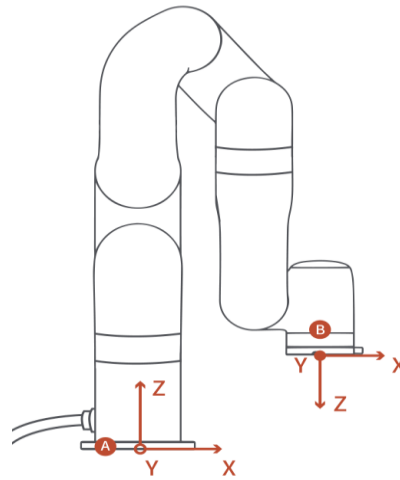

A: Base coordinate system

B: Tool coordinate system

The default TCP coordinate system is defined at the centre point of the end flange of the robotic arm, and it is the result of rotating $[180^\circ, 0^\circ, 0^\circ]$ around the X/Y/Z-axis of the base coordinate system in order. The spatial orientation of the TCP coordinate system changes according to the changes of the joint angles.

- Roll/Pitch/Yaw respectively rotates around X/Y/Z of the base coordinate system, and the final TCP orientation is the result of the three rotations in exact order. The robotic arm will always choose the shortest way to reach target orientation. In particular, it is important to strictly control the magnitude of the deflection angle between the two points to control the direction of rotation, and if necessary, insert a third point between the two points. As shown in figure 6.4, if a deflection is needed from position point A to point B,

the robotic arm moves in the direction of α angle. If the robotic arm needs to be moved in the direction of the β angle, a new position between the angles of β should be inserted, and the angle that formed by the inserted point and A should be smaller than α .

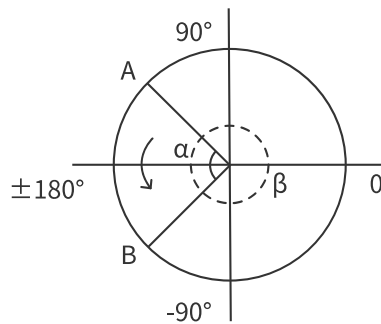

- The $+180^\circ$ and -180° points of the Roll/Pitch/Yaw are coinciding in the space, and the valid range is $\pm 180^\circ$, so it is possible to have both $\pm 180^\circ$ when the robotic arm is reporting the position.
- Roll angle, pitch angle, and yaw angle (RPY). The RPY rotation matrix (X, Y, Z" rotation) is determined by the following formula:

$$R_{rpy}(\gamma, \beta, \alpha) = R_Z(\alpha) \cdot R_Y(\beta) \cdot R_X(\gamma)$$

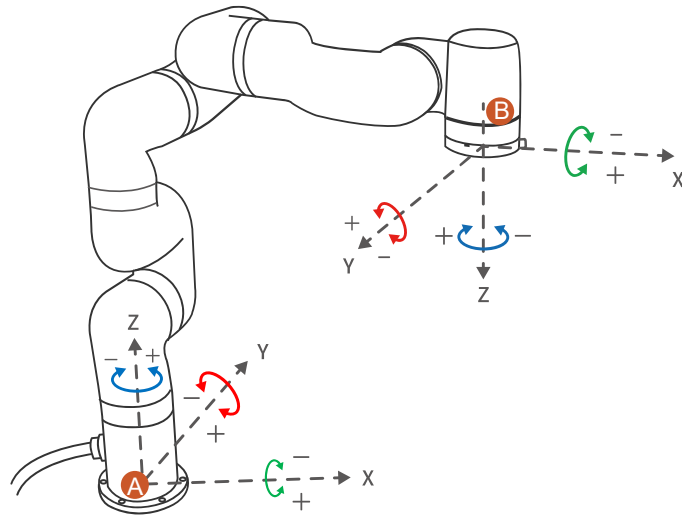

A: base coordinates

B: TCP coordinates(if no offset)



DANGER

1. You must check the TCP offset before recording the Cartesian position.

1.5.7 Operation Mode

1.5.7.1 xArm 6 (xArm 7) Operation Interface

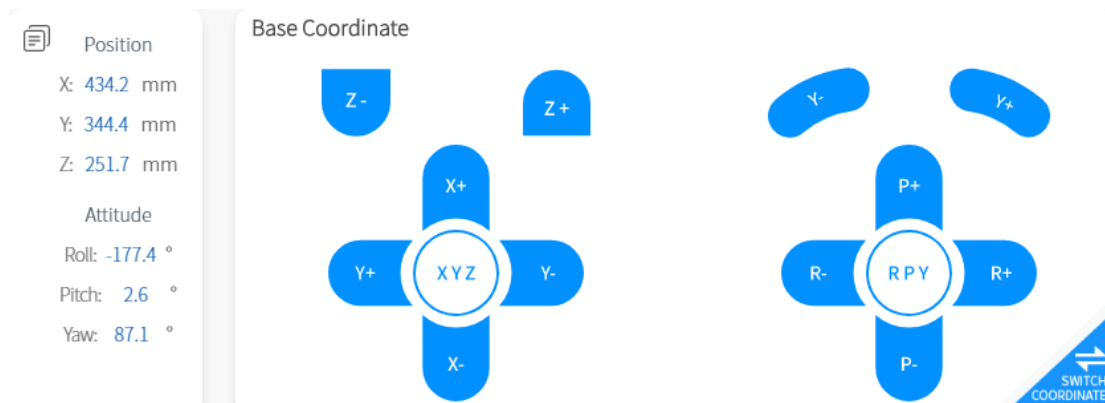

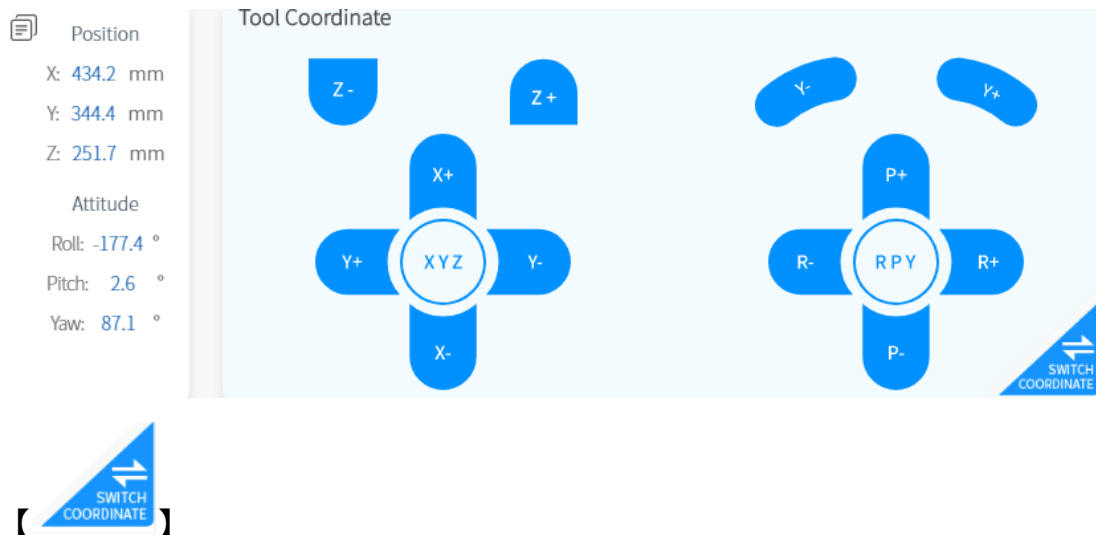

- It can switch the control functions between the base coordinate system and the tool coordinate system.

【Position/Attitude Real-time Display】

- X / Y / Z represents the coordinates of the tool center point (TCP) position of the robotic arm under the base coordinate offset.
- Roll/Pitch/Yaw under the Attitude indicates the angle value rotated under the base coordinate offset, which is a description of the azimuth obtained by rotating three times around the selected coordinate system in a certain order.

【Real-time Position Control】

- X/Y/Z controls the X/Y/Z-axis of the selected coordinate system respectively. Click for step motion and long press for continuous motion.

【Real-time Attitude Control】

- Roll/Pitch/Yaw controls the Roll/Pitch/Yaw of the selected coordinate system respectively. Click for step motion and long press for continuous motion.

The step can be set by clicking **【Settings】** - **【Motion Settings】** - **【Line Motion】** - **【Attitude Step】** on the homepage.

1.5.7.2 xArm 5 Operation Interface

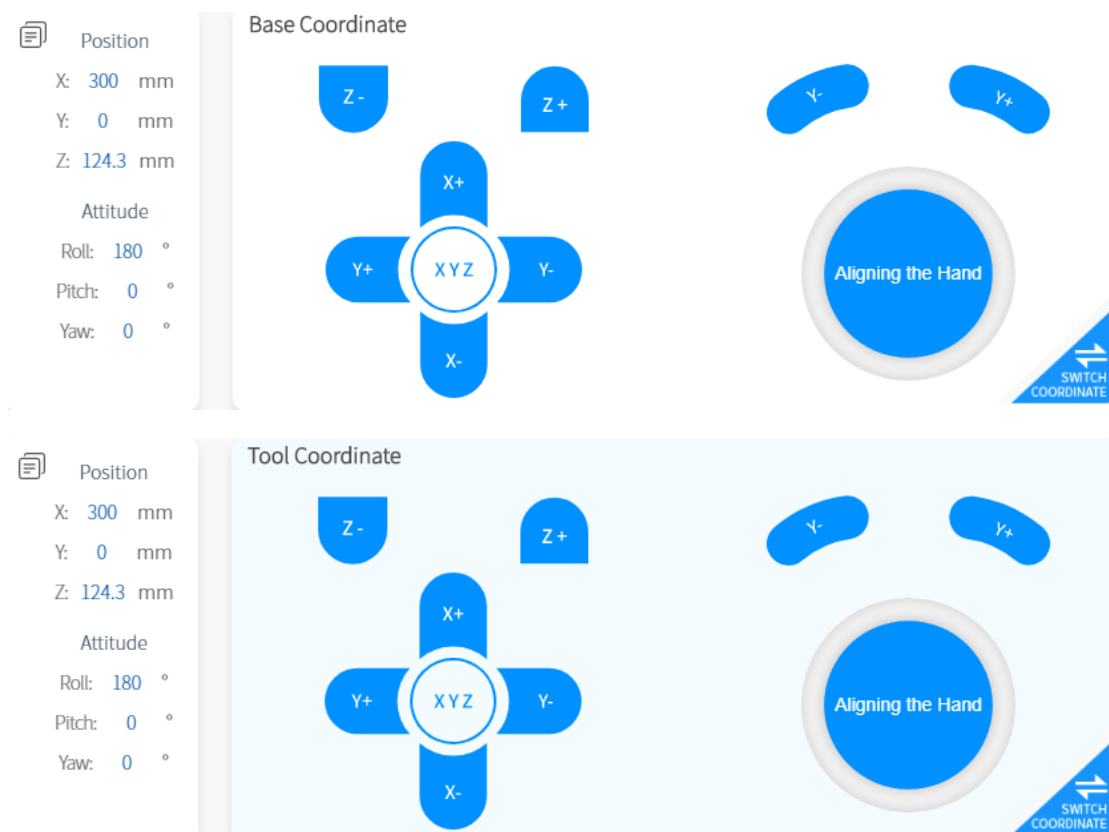

【Aligning】

- After clicking this button, the tool flange will be adjusted to a horizontal attitude, that is, pitch and roll will be adjusted to the fixed values of 0 ° and 180 °.

1.5.8 Zero Position, Initial Position

【ZERO POSITION】

- Indicates all joint angles values are zero.

Long press the button of Zero Position to return the robotic arm to the posture of Zero Position. This button blaks collision detection.

User can click 【Settings】 — 【Motion Settings】 — 【Initial Position】 on the homepage to set the Initial Position.

Click 【ZERO POSITION】 【INITIAL POSITION】 for step motion, long press them for continuous motion.



DANGER

If the end-effector is installed in the robotic arm, make sure to assess whether the robotic arm will hit the obstacles or the fixed surface of the robotic arm when it returns to the zero pose.



CAUTION

The robotic arm should be back to the zero pose before packaging.

1.5.9 Speed Setting

It is used to adjust the motion speed of the live control interface of xArm. (Note that the maximum speed of the live control interface is not the actual maximum motion speed of the robotic arm. If you want the

program to run at high speed, you can add a speed command in the Blockly motion program).

Joint Operating Speed

- The range is $1^\circ/\text{s} \sim 180^\circ/\text{s}$. When the robotic arm is in operation, the actual maximum speed will be influenced by the payload, speed, and the pose, and the maximum speed would not be an absolutely reachable value.

Note: the speed at which the joint runs between each command is not continuous, and the robotic arm will have a brief pause between joint command.

TCP Operating Speed





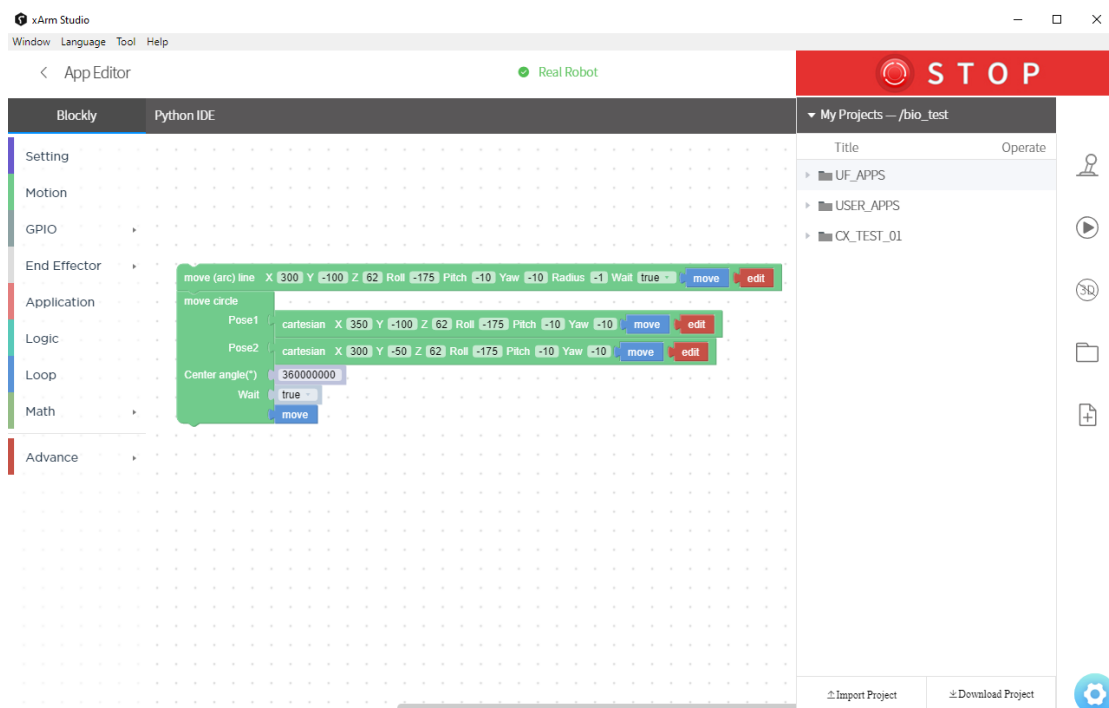

- The Cartesian speed range is from $1\text{mm}/\text{s}$ to $1000\text{mm}/\text{s}$. The actual maximum speed is also affected by the payload, speed, and posture of the robotic arm. If the set speed is close to the limit speed, the robotic arm will slow down or cause an error mechanism. When a command involves displacement and rotation, at the same time, the time required for the displacement motion and the rotational motion depends on the one that takes more time, but in principle, it is better to separate the displacement from the rotation command.

1.6 Blockly Graphical Programming

Blockly is a graphical programming tool that can be programmed to control the robotic arm by dragging and dropping code blocks without the need to write the code manually.

1.6.1 Interface Overview



- 【  】 Open/Close the live control page.
- 【  】 Create button, to create a new Blockly file.
- 【  】 Run button to run the Blockly program that has been written.
- 【  】 Click to create a new folder.
- 【  】 Save the changes.
- 【  】 Cancel the changes.

Python IDE Can be converted to Python code and can be used in the xArm-Python-SDK library.

My Project— "xxx" Click to expand to display all created items, the currently open item "xxx" is displayed when it folds.

Import Project Click to import the Blockly project from the local drive.

Download All Click to download all projects.

3D Click this button, and the 3D simulation model of the robotic arm in the real-time control interface will pop up (as shown in the figure below). When running the program, you can observe the motion posture of the robotic arm in real time.

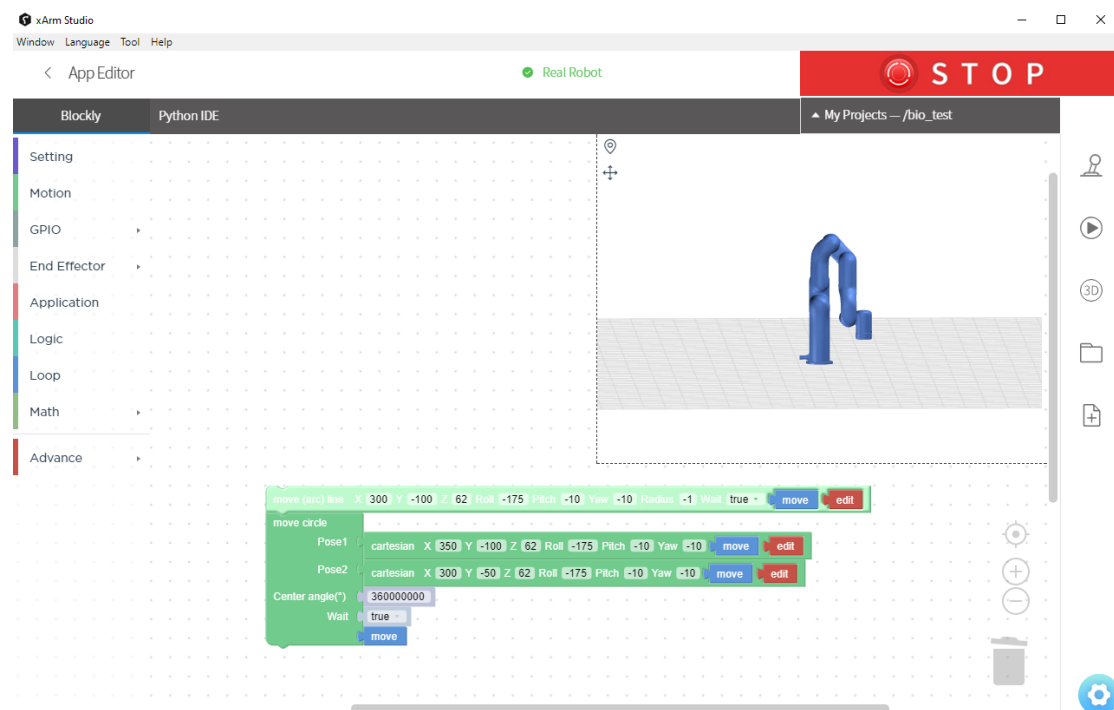



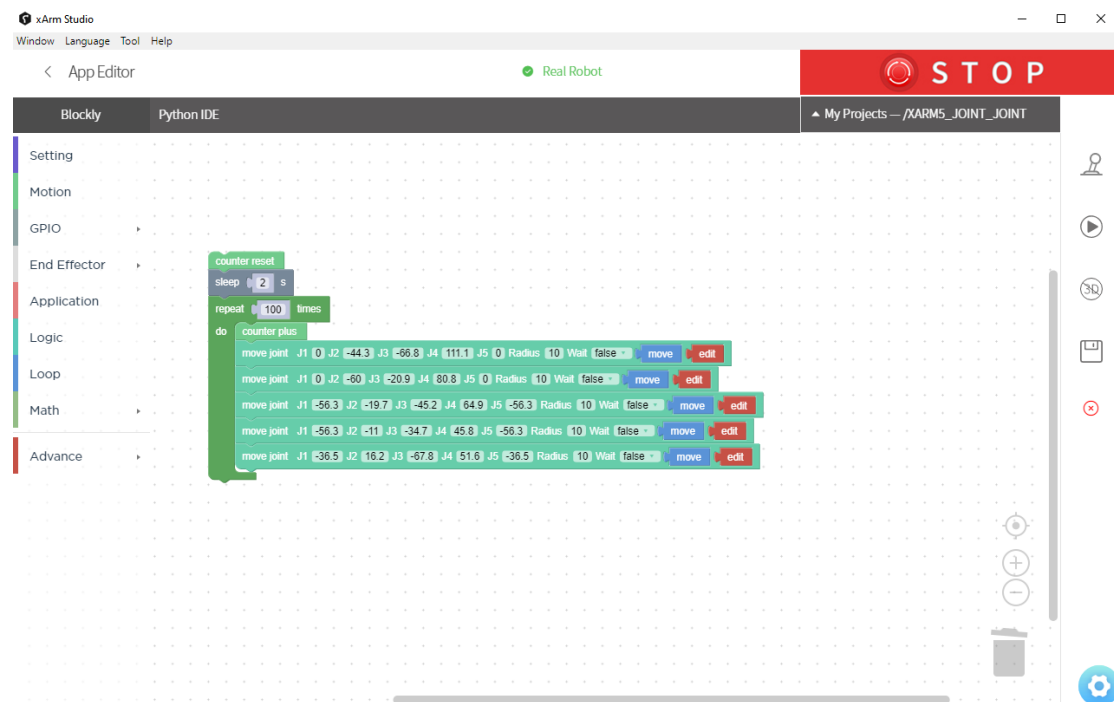

Note: When the robotic arm is in the simulation mode, you can also run

the Blockly motion program to observe the motion of the virtual robotic arm.

1.6.2 Blockly Workspace



Drag the code block into the action panel, the code execution is top-down, users can drag and drop the code block with the blocks attached from behind together.

- 【】 Return to the default size and code block at centered position
- 【】 Zoom in on the code block.
- 【】 Zoom out on the code block.
- 【】 To delete the code block, simply drag it to the trash, or press the **[enter]** / **[delete]** key after selecting the code block.

1.6.2.1 The Right Click Mouse Event in the Workspace

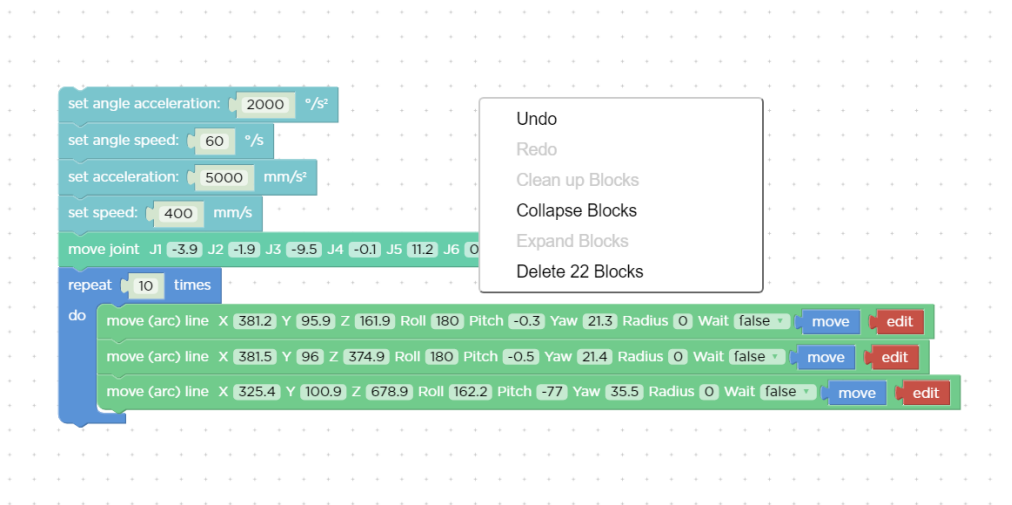

Right-click on the blank workspace of the non-code block, the function is mainly for all code blocks:

【Undo】 : Undo the previous operation.

【Redo】 : Restore the last undo operation.

【Collapse Blocks】 : Collapse all code blocks.

【Expand Blocks】 : Display all collapsed commands.

【Delete 30 Blocks】 : Delete all code blocks.

1.6.2.2 The Right Click Mouse Event of the Code Block

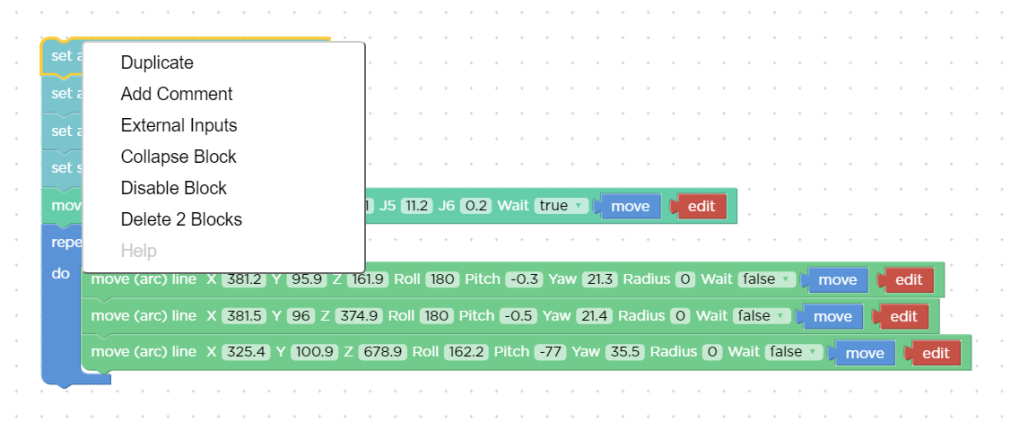

Right-click in the code block, the function of each module pop up:

【Duplicate】 : Copy all code blocks of the current workspace, copy/cut shortcuts with the keyboard and paste them into other files.

【Add Comment】 : Users can add a description to the code block, which is identified by the symbol . Click to open/close the description pop-up window, as shown in the following figure.

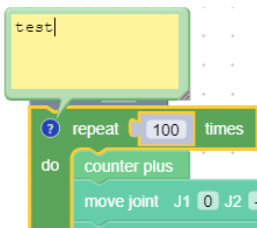

【External input】 : The location for setting the text box is displayed at the far right.

【Internal Input】 : The location for the setting of the text box to be displayed in the default middle position.

【Collapse Block】 : Folds the code block of the current workspace.

【Disable Block】 : Stop the execution of the running command of the current code block. The opposite is **【Enable Block】** .

【Delete 82 Blocks】 : Delete the current code block selected by the mouse click.

【Help】 : Jump to the Help Page of the corresponding code block.

1.6.2.3 Move/Wait/Edit

For some common functions of the motion commands, click **【move】** and the robotic arm will move to the current position; click **【edit】** ,

Then the robotic arm will move to the current position and open the live control interface; Wait (true/false), indicating whether to wait for the execution of a command before sending the next one.

1.6.3 Blockly Code Block

Setting: Used to set the running speed, acceleration, collision sensitivity, load, etc. of the robotic arm.

Motion: Common motion commands including linear motion, joint motion, linear motion with arc, sleep time, zero point, and emergency stop.

Application: You can import Blockly other projects.

GPIO: External input signal triggered event (suitable for plc).

End-Effector: Contains common commands to control the end-effector, such as gripper, vacuum gripper.

Logic: Contains commonly used logic commands.

Loop: Contains common loop commands such as multiple loops, infinite loops, and breaking loops.

Math: Contains commands for mathematical operations.

Advanced: Includes location notes and message reminders.

1.6.4 Setting

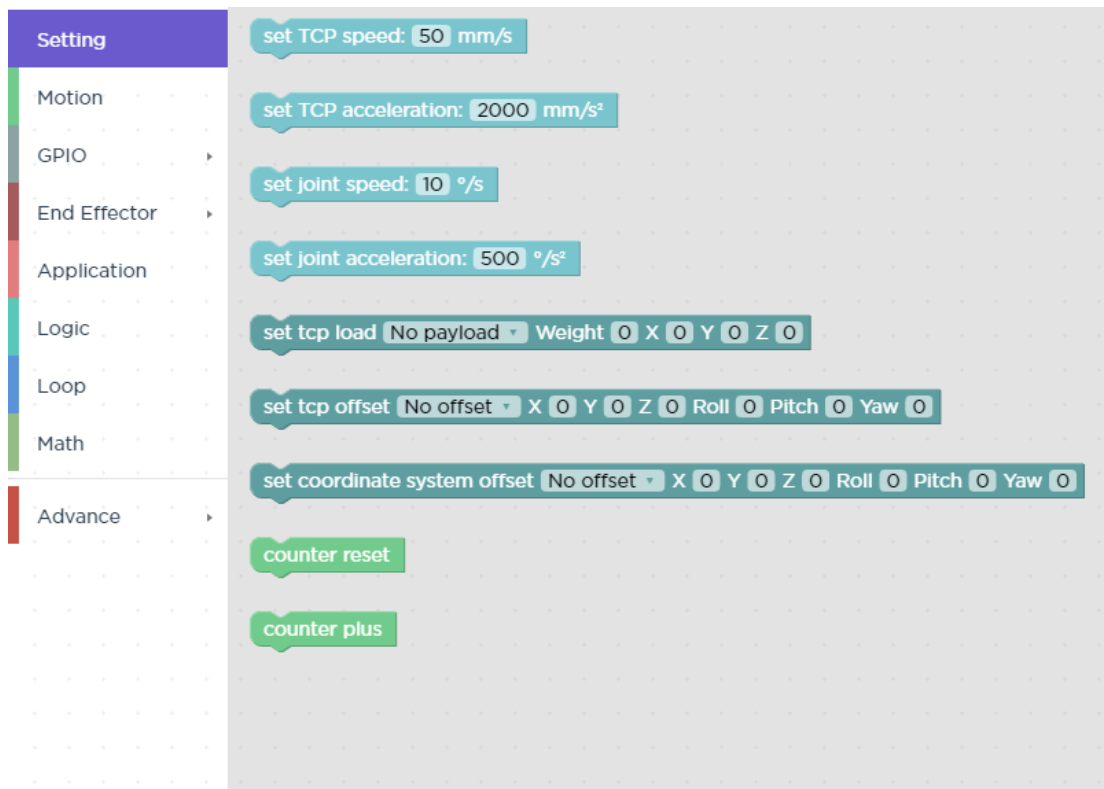

【Set TCP speed () mm/s】

- Set the speed of the linear motion in mm/s.

【Set TCP acceleration () mm/s²】

- Set the acceleration of the linear motion in mm/s².

【Set joint speed () °/s】

- Set the speed of joint movement in °/s.

【Set joint acceleration () °/s²】

- Set the acceleration of joint motion in $^{\circ}/s^2$. The default speed and acceleration values in the code block are the speed and acceleration values set currently, which can be modified manually.

【Set tcp load () weight () XYZ】

- Set the load of the current project, refer Settings-TCP Payload from the drop-down list.

【Set tcp offset () X Y Z R P Y】

- Set the end offset of the current project, reference Settings-TCP Offset from the drop-down list.

【Set world offset () X Y Z Roll Pitch Yaw】

- Set the base coordinate offset of the current project. The drop-down list refers to the data of the Setting-Base Coordinate Offset.

【Counter reset】

- This command resets the counter in the control box to 0

【Counter plus】

- Each time the command is run, the counter of the control box will be incremented by 1. It can be used to calculate the number of times the program actually cycles.

1.6.5 Motion

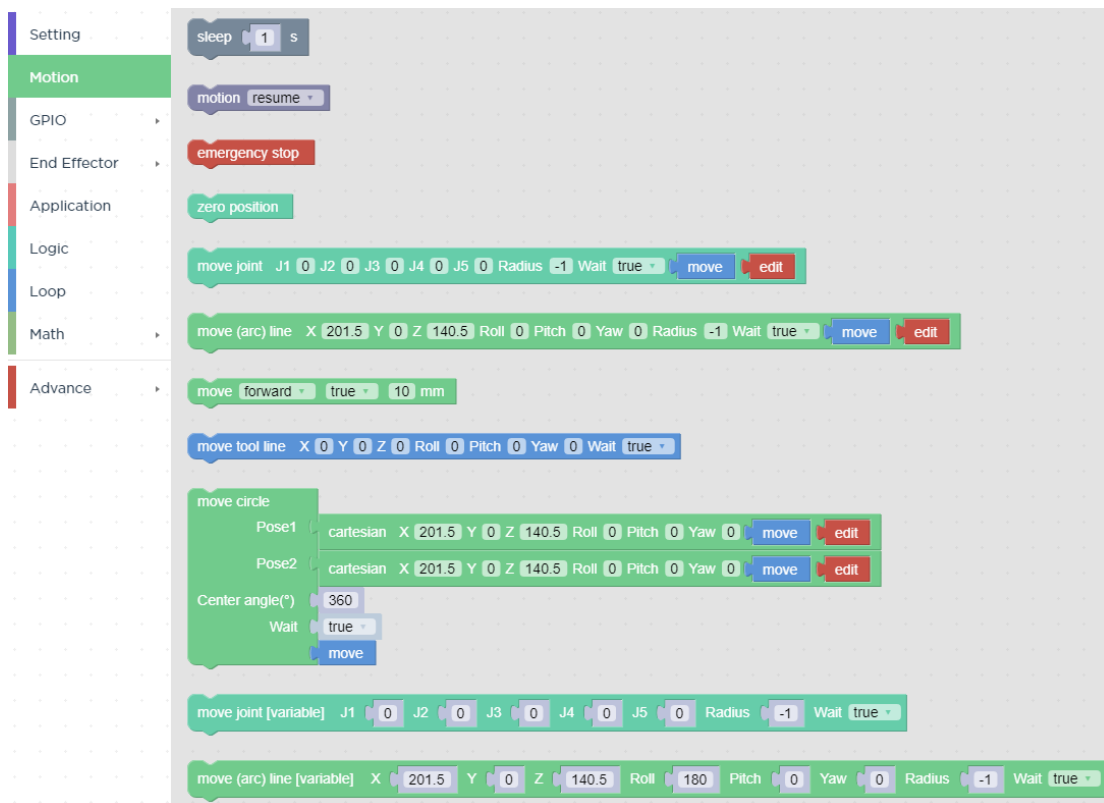

【sleep () s】

- After receiving this command, the robotic arm will stop moving for the set time, and then continue to execute the following commands. It is mainly used in motion programs that need to do the continuous motion. It is used to buffer more motion commands for successful continuous motion calculation.

【motion ()】

- With this command, operators can set the state of the robotic arm (movement, pause, stop). It is used to control the state of the robotic arm. It is mainly used in condition-triggered programs.

【emergency stop】

- The robotic arm immediately stops moving and clears the command cache.

【zero position】

- The robotic arm returns to a posture where the joint value are 0.

【move joint J1() J2() J3 () J4() J5() J6() J7() Radius()

Wait(true/false) ,[move] , [edit]】

- Set each joint value for the joint movement, with the unit of degree.

【move(arc) line X() Y()Z() Roll() Pitch() Yaw() Radius() Wait(true/false)

[move] [edit]】

- Set the Cartesian coordinate target value of the linear motion and the TCP rotation angle in mm and °.

【move (front/back/left/right) (true/false)() mm 】

- Indicates that the robotic arm makes relative linear motion

forward/backward/left/right based on the current position, in mm

【move tool line X() Y()Z() Roll() Pitch() Yaw() Radius() Wait(true/false) 】

- This command is a relative motion relative to TCP coordinates.

【move circle position 1 to position 2】

- From current position, the whole circle is determined by current position and position1 and position2, “center angle” specifies how much of the circle to execute.

【center angle (°) () 】

- Indicates the degree of the circle. When it is set to 360, a whole circle can be completed, and it can be greater than or less than 360; (Note: To achieve smooth track motion, you need to set Wait = false).

【move joint [variable] J1() J2() J3 () J4() J5() J6() J7()
Wait(true/false)】

- The command passes through the joint motion and supports variable values.

【move (arc) line [variable] X() Y() Z() Roll() Pitch() Yaw() Radius()
Wait(true/false)】

- The command passes through the Cartesian motion and supports variable values.

1.6.6 GPIO (Control Box and End tool interface)

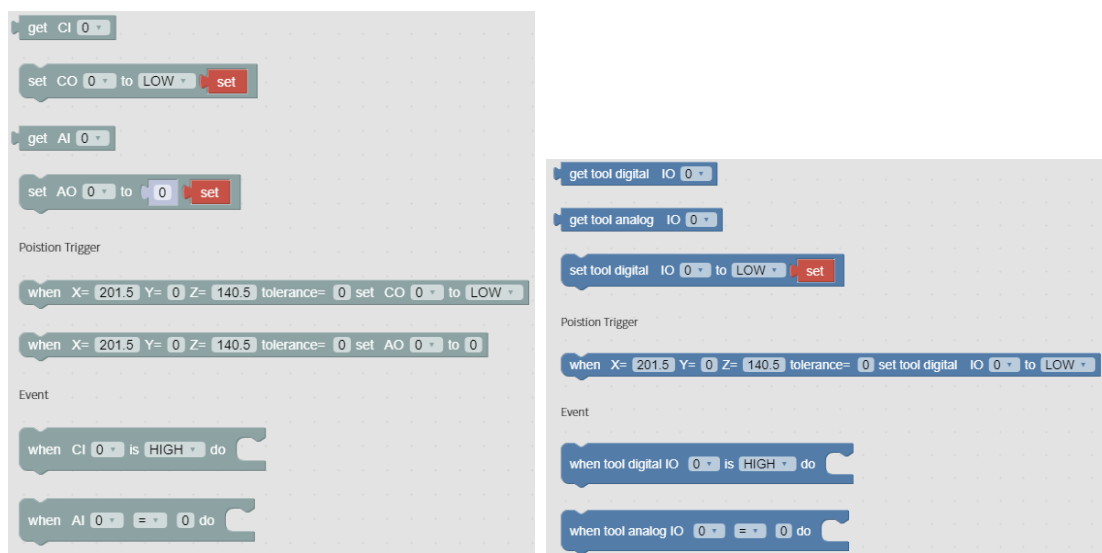

The IO interface is made up of a control box interface and an end tool interface, which can be used to acquire, set, and monitor IO interface

operations. The control box has 8 digital input interfaces, 8 digital output interfaces, 2 analog input interfaces, and 2 analog output interfaces. The end tool has 2 digital input interfaces and 2 digital output interfaces. 2 analog input interfaces. The control box digital IO is low-level-triggered. The end tool digital IO is high-level-triggered.

【get I/O 】

- Acquire the I/O interface data of the code block.

【set I/O 】

- Set the I/O interface of the code block, click **【Set】** to run the command.

【set I/O when (X, Y, Z, tolerance) 】

- When the robotic arm reaches the specified position (the area of the sphere specified with the trigger position point (X, Y, Z) as the center (the radius of the sphere is the tolerance radius)), IO is triggered. This command can be used to trigger IO at a specific location.

X, Y, Z represent the coordinate value of the specified position to be reached by the robot arm, with the unit of mm.

The digital IO is triggered as soon as the system detects that the TCP position enters a spherical area centered at (X,Y,Z) with the specified radius. If the tolerance radius is not set, when the robotic arm passes

the specified point at a speed other than 0, it may miss the trigger because it cannot be accurately detected.

【when digital I/O is (High/Low) do 】

- Executes the commands contained in this code block when the condition is met.

【 when the analog IO value satisfies the set condition do 】

- When the monitored analog IO value meets the condition, the commands contained in the code block will be executed, and the condition are =, ≠, >, ≥, <, ≤.

IO trigger logic of xArm Studio:

1. xArm Studio obtains the IO state every 100ms, and uses the IO state value obtained for the first time as the initial value.
2. Compare the IO state obtained the second time with the IO state obtained last time. If the IO state changes, a callback meeting the condition is triggered.

1.6.7 End Effector



【set xarm gripper Pos () Speed () Wait (true / false)[move][edit]】

- Set the position and the opening and closing speed of the gripper.

【set bio gripper Speed () Wait (true / false)[move][edit]】

- Set the opening and closing speed of the gripper.

【set robotiq gripper Pos () Speed () Wait (true / false)[move][edit]】

- Set the position of robotiq gripper, opening and closing speed, and the strength of the gripping object.

【initialize gripper】

- Enable gripper.

【object is (picked/release) 】

- Detect whether the vacuum gripper has picked (released) the object.
If it is detected that the vacuum gripper has picked (released) the object, then jump out of this command and execute the next command. If the timeout period is exceeded, the vacuum gripper has not yet picked (released) the object, it will also jump out of the command and execute the next command.

【get xarm vacuum gripper state】

- Obtain whether the vacuum gripper picks the object or not. When the vacuum gripper state is 1, it indicates that the object is picked successfully; when the vacuum gripper state is 0, it indicates that the object fails to be picked.

【set xarm vacuum gripper (ON/OFF) object detection (true/false)

[set]】

- Set the vacuum gripper to be on and off.

[object detection] = true: detect whether the object is picked, if not, it will jump out of the entire program.

[object detection] = false: do not detect whether the object is picked.

1.6.8 Application

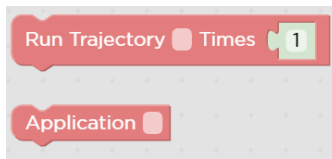

【Run Trajectory (path) Times [1]】

- Users can import the trajectory recording file and set the times of executions.

【Import other APP】

- Users can import Blockly of other projects.

1.6.9 Logic

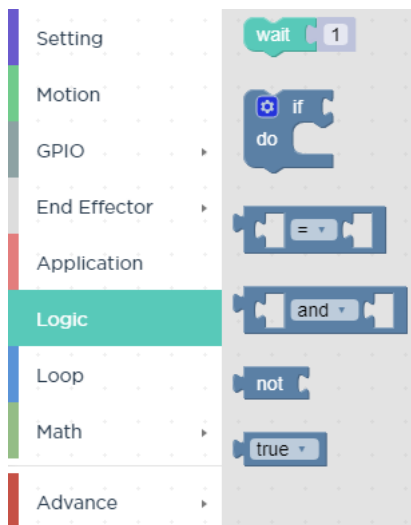

【wait ()】



- Wait for the next command to be sent, with the unit of seconds.

【if (Condition 1) Run (Command 1)】

- If Condition 1 is true, then Command 1 will be run. Otherwise, it will

be skipped.

The setting method of the if/else sentence:

1. Click the setting button  on the command block , then the command block will pop up a selection box, as shown below:

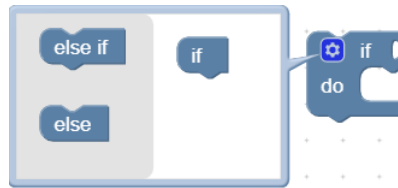

2. At this point, drag the [else] code block to the bottom of the [if] code block, and combine the two code blocks, as shown below:



3. Click the setting button , the selection box is retracted, if /else sentence setting is completed, as shown below:



1.6.10 Loop

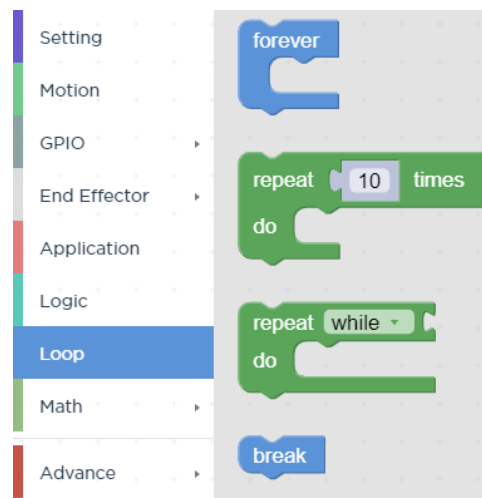

【forever】

- The command contained in the loop will be executed in infinite loop.

【repeat() times do】

- The command contained in the loop will be executed X times.

【repeat while/until do】

- When the condition is not met, it jumps out of the loop.

【break】

- Terminate the loop.

1.6.11 Math

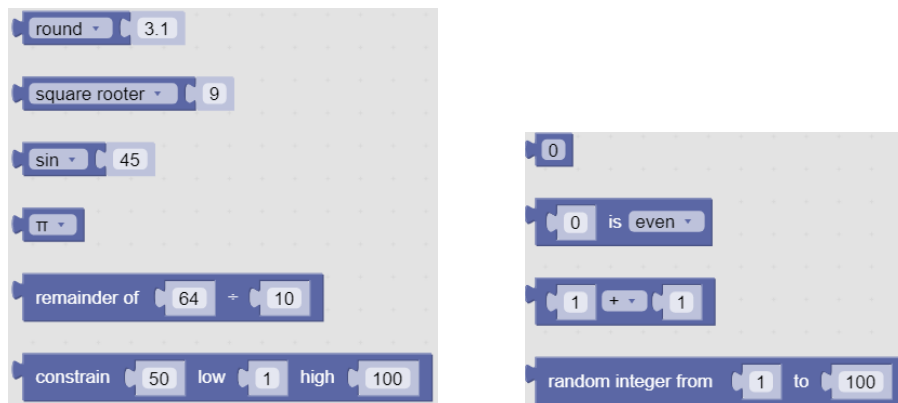

You can use the above code block to do some complex operations such as addition, subtraction, multiplication, and division, exponential operations.

1.6.12 Text

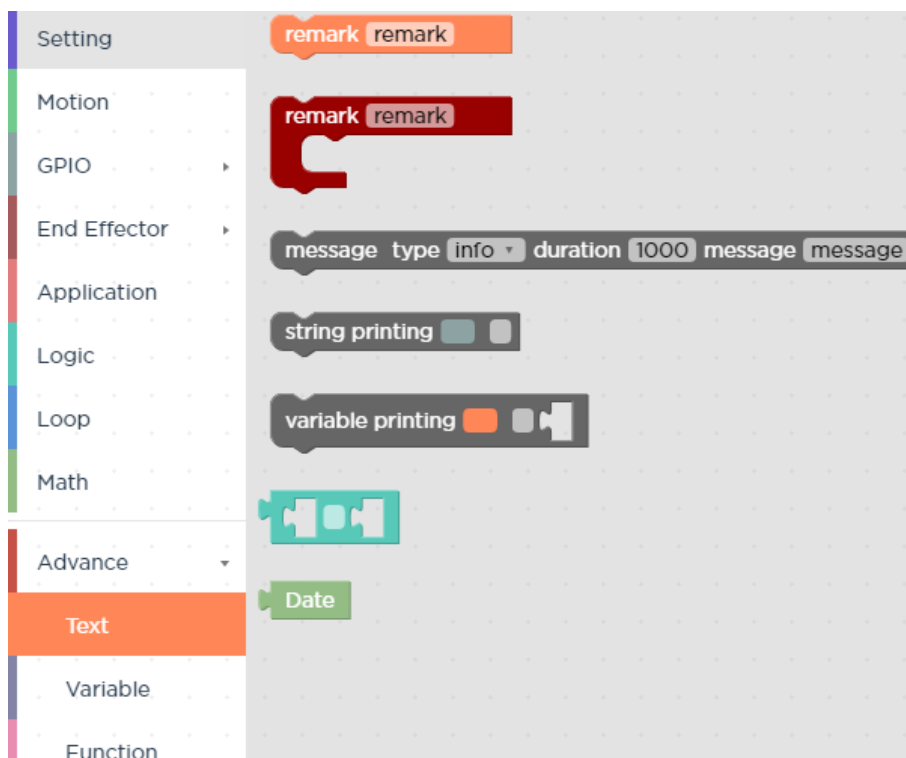

【remark】

- Remark the code block, which serves as an indicator and can change the color.

【message type】

- Types available are: (information/success/warning/error), duration indicates the time interval the message is displayed, the unit is in second; the message indicates the content of the prompt message.

【string printing[]】

- Users can print the entered string below and set the font and the color.

【variable printing】

- Users can print the added variable and set the font and the color.

【Date】

- The date and time on which the command was run can be output.

1.6.13 Variable

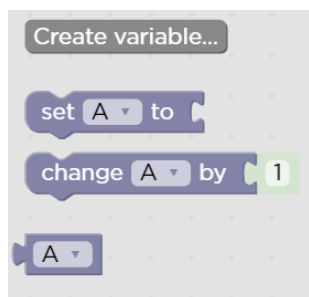

【Create variable】

- New variables can be added. After adding a variable, there are three commands by default (set the value of the variable, change the value

of the variable by adding or subtracting, variable).

【Rename variable】

- Rename the variable.

【Delete variable】

- Delete the variable.

1.6.14 Function

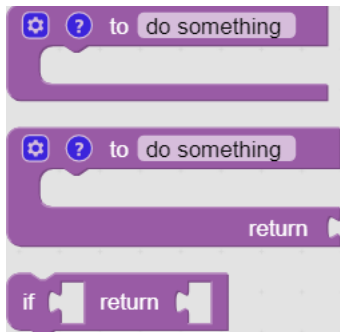

【to (do something)】

- Users can define a new function without a return value.

【to (do something) return []】

- Users can define a new function with a return value.

【if [] return []】

- Conditional judgment sentence that can only be placed in the built-in function.

Note:

1. The defined function should be placed in front of the main programs.

1.6.15 Set & Edit Motion Coordinates

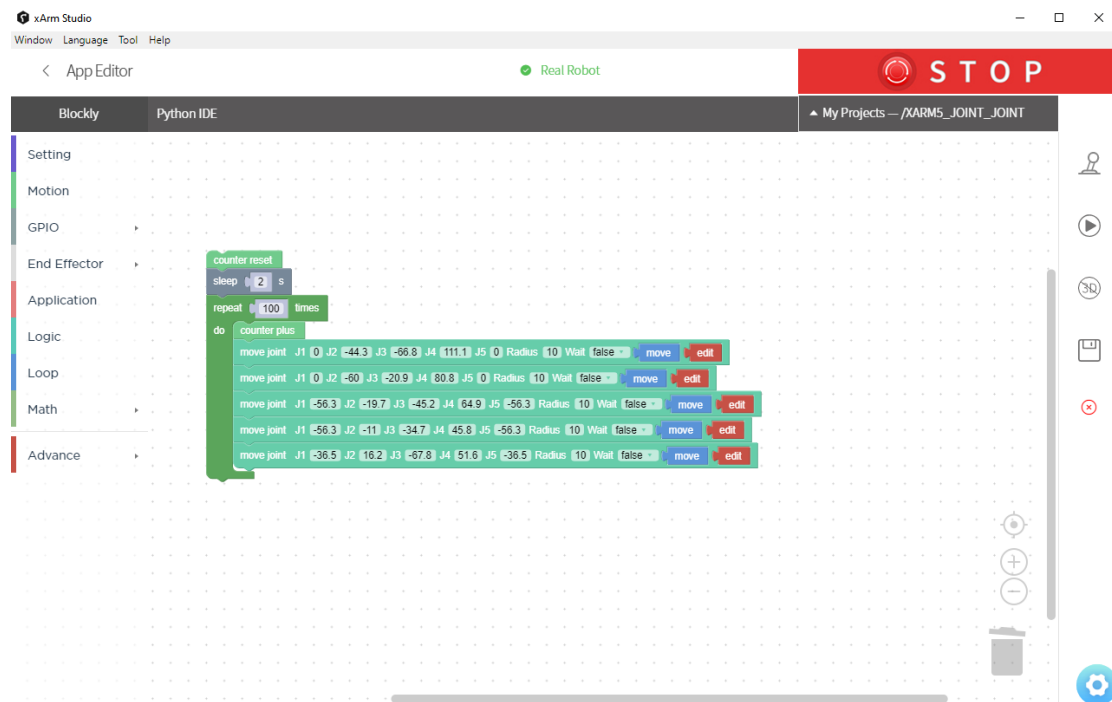

Long press **【Move】** button to move the robotic arm to the position of the current command.

Click **【edit】** to pop up the live control interface to re-edit the motion coordinates of the current command.

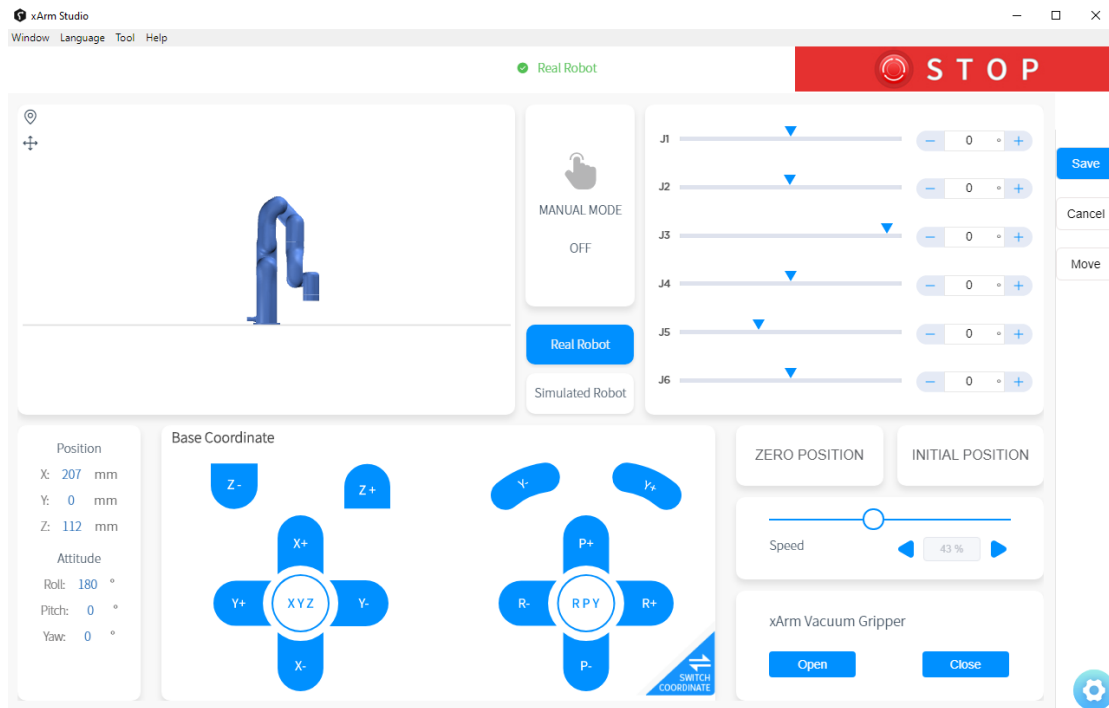

Click **【Save】** to save the changes and close the pop-up window.

Click **【Cancel】** to cancel the changes and close the pop-up window.

Note: In the command, there are sequential points such as A / B / C / D. Etc. If the user clicks **【move】** to skip point B from point A to point C, a safety assessment must be carried out to avoid damage to peripheral facilities

Due to the complexity of Cartesian commands, Cartesian spatial trajectory planning needs to be solved by inverse kinematics. Therefore, there may be no solution, multiple solutions, approximate solutions.

When the solution of the Cartesian command from point A to point B is not ideal, insert a third joint command between the two points if necessary.

1.6.16 Path Planning Guidelines



DANGER

- If the robotic arm is collided during the movement, resulting in stopping, the robotic arm will report an error at this time, and the error must be cleared before it can be used normally. Be sure to do a safety assessment before moving again to prevent collisions.



CAUTION

- When the robotic arm is in certain positions, there may be a situation where the linear motion is unsolvable. At this time, the route needs to be re-planned. For details, please refer to "xArm Kinematics-Linear Motion".

1.7 Python IDE

Python IDE is a Python development integration environment that can directly use xArm-Python-SDK API and check the Blockly projects converted into Python code.

```
1 #!/usr/bin/env python3
2 # Software License Agreement (BSD License)
3 #
4 # Copyright (c) 2019, UFACTORY, Inc.
5 # All rights reserved.
6 #
7 # Author: Vinman <vinman.wen@ufactory.cc> <vinman.cub@gmail.com>
8
9 """
10 # Notice
11 # 1. Changes to this file on Studio will not be preserved
12 # 2. The next conversion will overwrite the file with the same name
13 """
14 import sys
15 import time
16 import threading
17
18 """
19 # xArm-Python-SDK: https://github.com/xArm-Developer/xArm-Python-SDK
```

 Create a new project.

 Create a new file.

 Create a new folder.

 Rename.

 Delete the file.

 Run the file.

1.7.1 Create a New Project

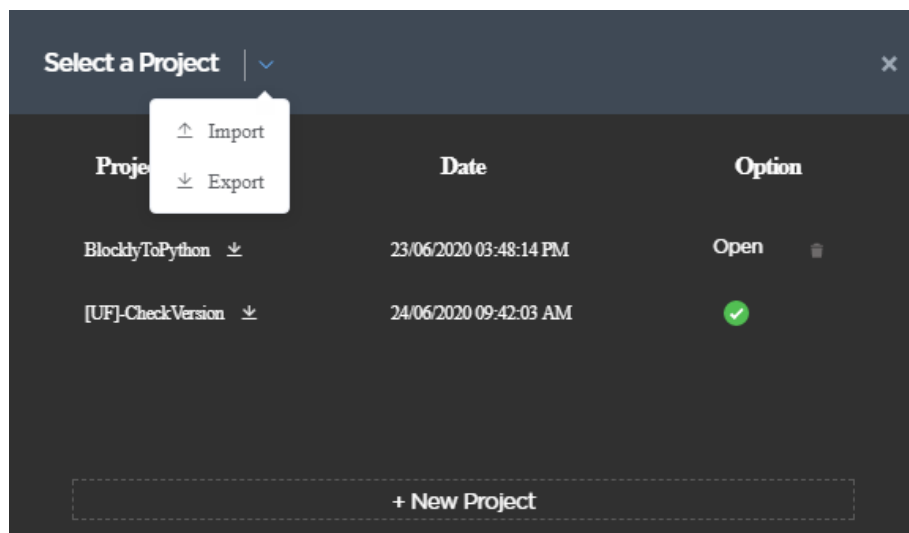

On this page, all current project files are displayed, including Blockly projects converted into Python code.

 Import projects.

 Export projects.



Display the current open project and the time it was created.

 Delete projects.

【Open】 Open the projects and display them in the edit box.

Note:  24/06/2020 09:42:03 AM, The project folder is not available, please create a new project by yourself.

Control Box Command Caching Mechanism:

The current control box can cache 2048 commands. If more than 2048 commands need to be sent, user have to control the cached number and control the volume. When awaiting commands of the control box exceed the maximum buffer amount (2048), a warning code will be returned. The warning code is decimal 11, and the command will be discarded. The commands issued should not exceed 256 command caches.

It is recommended to keep the number of cached/sent commands under 256 all the time.

1.8 Recording

The position of the joint is obtained and recorded by 250HZ to record the motion trajectory of the robotic arm in free driving, and the maximum recording time is 5 minutes. The playback will completely repeat the motion trajectory during recording, and the playback speed

of the trajectory can be set (x_1 , x_2 , x_4). A recorded trajectory can be imported into Blockly projects.

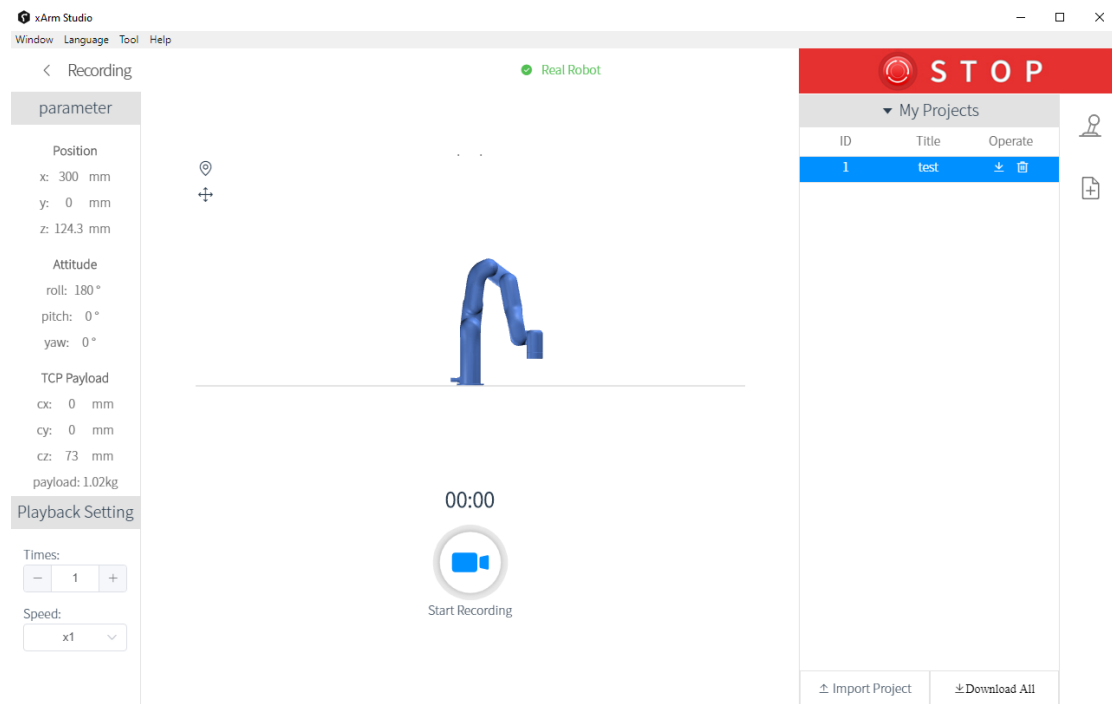

【  】 Pop-up live control panel.

【  】 Create a new recording file.

【  】 Manual Mode will be turned on accordingly by clicking on the button, and the robotic arm can be dragged directly for trajectory recording. When starting recording, be sure to pay attention to the load state of the robotic arm, so as to avoid the big difference between the actual load and the set load of the robotic arm, resulting in its self-motion.

【 00:04 】 Display recording time.



【 Stop Recording 】 Stop recording.

【Times】 Set playback times.

【Speed】 Set playback speed.

【】 Download the file.

【】 Delete the file.

【Import Project】 Import recorded trajectory.

【Download All】 Download all current files.

2. xArm Motion Analysis

In this section, we mainly use Python / Blockly examples to explain a few typical motions in the list below.

Motion	<u>Joint</u> <u>Motion</u>	<u>Linear</u> <u>Motion</u>	<u>Arc linear</u> <u>motion</u>	<u>Circular</u> <u>Motion</u>	<u>xArm5</u> <u>Motion</u>
--------	-------------------------------	--------------------------------	------------------------------------	----------------------------------	-------------------------------

About Python-SDK:

For all interfaces with `is_radian`, the default value of `is_radian` is the value at the time of instantiation.

That is, the value of “`is_radian`” set when `xArmAPI ()` is created.

Here are three examples to illustrate:

```
1. arm = xArmAPI('192.168.1.226')
2. arm = xArmAPI('192.168.1.226', is_radian=False)
3. arm = xArmAPI('192.168.1.226', is_radian=True)
```

When the `xArmAPI()` interface is created in method 1, the default value of `is_radian` is `False`, the unit is `°`;

When the `xArmAPI()` interface is created in method 2, `is_radian = False`, the unit is `°`;

When the `xArmAPI()` interface is created in method 3, `is_radian = True`, the unit is `rad` ;

About Blockly:

All units for angles use degrees (`°`).

2.1 Robotic Arm Motion Mode and State Analysis

2.1.1 The Motion Mode of the Robotic Arm

Motions of the robotic arm: joint motion, linear motion, linear circular motion, circular motion, servo motion and servo_cartesian motion.

The following motions are in position mode (Please refer to 【Robot Movement & Status Analysis】):

- Joint Motion: to achieve the point-to-point motion of joint space (unit: degree/radian), the speed between each command is discontinuous.
- Linear Motion: to achieve linear motion between Cartesian coordinates (unit: mm), the speed between each instruction is discontinuous.
- Arc Linear Motion: to achieve linear motion between Cartesian coordinates (unit : mm), inserting an arc between two straight lines for a smooth transition, and the speed between each command is continuous.
- Circular Motion: Circular motion calculates the trajectory of the spatial circle according to the three-point coordinates, the three-point coordinates are starting point, parameter 1 and parameter 2.

The following motion modes are in servoj mode:

- Servoj motion: move to the given joint position with the fastest speed ($180^\circ/s$) and acceleration (unit: degree/radian). This command has no buffer, only execute the latest received target point, and the user needs to enter the servoj mode to use. In servoj mode, the maximum receiving frequency of the control box is 250Hz (the maximum receiving frequency of the version before 1.4.0 is 100Hz). If the frequency of sending commands exceeds 250Hz, the redundant commands will be lost. The xArm-Python-SDK interface function we provide also reserves the speed, acceleration and time settings, but they will not work at present. The suggested way of use: If you want to plan your track, you can use this command to issue a smoothed track point with interpolation at a certain frequency (preferably 100Hz or 200 Hz), similar to the position servo control command. (Note: this execution is similar to the step response, for safety considerations, do not give a distant target position at once). Using this mode requires detailed position planning for each axis and motion estimation of the robotic arm, which is difficult to develop.
- Servo_cartesian motion: move to the given cartesian position with the fastest speed (1m/s) and acceleration (unit: mm). This command

has no buffer, only execute the latest received target point, and the user needs to enter the servoj mode to use. In servoj mode, the maximum receiving frequency of the control box is 250Hz (the maximum receiving frequency of the version before 1.4.0 is 100Hz). If the frequency of sending commands exceeds 250Hz, the redundant commands will be lost. The xArm-Python-SDK interface function we provide also reserves the speed, acceleration and time settings, but they will not work at present. The suggested way of use: If you want to plan your track, you can use this command to issue a smoothed track point with interpolation at a certain frequency (preferably 100Hz or 200 Hz), similar to the position servo control command. (Note: this execution is similar to the step response, for safety considerations, do not give a distant target position at once). It is recommended that the frequency of user issuing commands be controlled within the range of 30Hz-250Hz. If the frequency is lower than 30Hz, the motion of the robotic arm may be discontinuous. Using this mode requires planning the fine position of each axis and predicting the motion behavior of the robotic arm, which is difficult to develop.



CAUTION

Operators who design the robotic arm motion path must be qualified with the following conditions:

1. The operator should have a strong sense of security consciousness, and sufficient knowledge on robotic arm operations.
2. The operator should have in-depth knowledge on the robotic arm and understands the joint motion mode and the linear motion mode.
3. The operator should have safety knowledge on emergencies.
4. When planning the path for the robotic arm, the risk assessment must be done and the operator should be cautious.

2.1.2 Analysis of Robotic Arm Movement Mode

4 motion modes of the control box: (Python SDK: `set_mode ()`)

- Mode 0: Position control mode.

In this mode, the robotic arm can execute a series of motion commands (joint motion, linear motion, circular motion, etc.) automatically planned by the control box, which is also the mode that the control box enters by default after startup.

- Mode 1: Servoj mode.

In this mode, the robotic arm can accept joint position commands sent at a fixed high frequency like 100Hz (Note: not a Cartesian commands). The robotic arm responds immediately after receiving each commands and executes at the maximum speed. If the user can complete the planning of the motion trajectory with smooth speed and acceleration and map it to the joint space, the servoj mode can replace the planning of the control box, and let xArm execute the user's own or third-party (such as ROS Moveit!) planning algorithm. Do not use this mode if users cannot implement trajectory planning and inverse kinematics by themselves.

- Mode 2: Joint teaching mode.

In this mode, the robotic arm will enter the zero gravity mode, and the user can freely drag the links of the robotic arm to complete the teaching function. If the drag teaching is completed, switch back to mode 0.

Note for safe use: Before turning on the joint teaching mode, be sure to confirm that the installation direction of the robotic arm and the TCP load are set correctly, otherwise the arm may not be able to remain stationary due to inaccurate gravity compensation!

- Mode 4: Cartesian teaching mode,(not yet available).

2.1.3 Analysis of the Motion Status of the Robotic Arm

3 states that the control box can set: (Python SDK: `set_state ()`)

- State 0: Start motion.

Can be understood as ready for motion or stand-by. In this state, the robotic arm can normally respond to and execute motion commands. If the robotic arm recovers from an error, power outage, or stop state (state 4), remember to set the state to 0 before continuing to send motion commands. Otherwise the commands sent will be discarded.

- State 3: Paused state.

Pause the currently executing motion and resume the motion at the interruption by setting state 0 again.

- State 4: Stop state.

Terminates the current motion and clears the cached subsequent commands. Need to set state 0 to continue the motion.

4 states that the control box can get: (Python SDK: `get_state ()`)

- State 1: In motion.

The robotic arm is executing motion commands and is not

stationary.

- State 2: Standby.

The control box is already in motion ready state, but no motion commands are cached for execution.

- State 3: Pausing.

The robotic arm is set to pause state, and the motion commands buffer may not be empty.

- State 4: Stopping.

This state is the state entered by default upon power-on.

Stop and on commands can be executed until state is set to 0.

- State 5: System reset.

The user just enters the state after the mode switch or changes some settings (such as TCP offset, sensitivity, etc.). The above operations will terminate the ongoing movement of the robotic arm and clear the cache commands, which is the same as the STOP state.

2.2. Motion of the Robotic Arm

2.2.1. Joint Motion

To achieve point-to-point motion in joint space (unit: degree), the speed is not continuous between each command.

Blockly example:

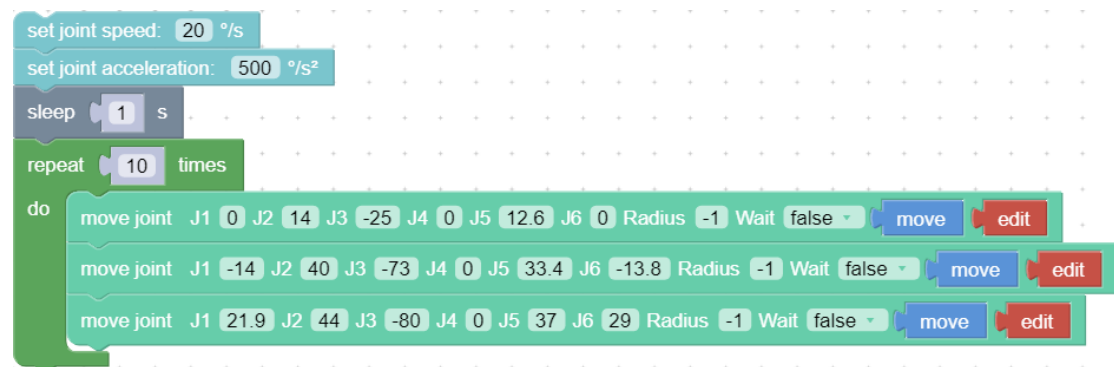

【Set joint speed() °/s】 : Set the speed of joint movement in °/s.

【Set joint acceleration() °/s²】 : Set the acceleration of joint motion in °/s².

【move joint J1() J2() J3 () J4() J5() J6() J7() ,Radius()】 : Set each joint angle for the joint movement, the unit is °.

【Wait (true / false)】 : indicates whether to wait for the execution of this command before sending the next command.

【Move】 : The robotic arm will move to the current position.

【Edit】 : Open the live control interface and adjust the coordinates of the current point.

The motion trajectory of the robotic arm in the above example is as follows:

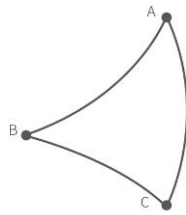

Python example:

```
arm.set_servo_angle(angle=[0.0, 7.0, -71.2, 0.0, 0.0, 0.0], speed=8, mvacc=1145, wait=True)
arm.set_servo_angle(angle=[0.0, 7.0, -51.2, 0.0, 0.0, 0.0], speed=8, mvacc=1145, wait=True)
arm.set_servo_angle(angle=[0.0, 7.0, -91.2, 0.0, 0.0, 0.0], speed=8, mvacc=1145, wait=True)
```

The interface `set_servo_angle` is described in Table 2.1:

Table 2.1 Description of `set_servo_angle`

set servo angle	
description	set joint angle for joint motion
parameter	<p><code>servo_id</code></p> <p>joint ID, 1-7, None or 8 means all joints:</p> <p>a) 1- (Number of axes) Joint number of the robotic arm</p> <p>E.g. : <code>arm.set_servo_angle (servo_id = 1, angle = 45, is_radian = False)</code></p> <p>b) None (8) represents all joints</p> <p>E.g. : <code>arm.set_servo_angle (angle = [30, -45, 0, 0, 0, 0, 0], is_radian = False)</code></p>
	<p><code>angle</code></p> <p>angle Joint angle or list of joint angles (the unit of the default joint angle is <code>is_radian = False</code>, degrees (°))</p> <p>a) If <code>servo_id</code> is 1- (joint number)</p> <p>E.g. : <code>arm.set_servo_angle (servo_id = 1, angle = 45, is_radian = False)</code></p> <p>b) If <code>servo_id</code> is None or 8,</p> <p>E.g. : <code>arm.set_servo_angle (angle = [30,45,0,0,0,0,0], is_radian =</code></p>

	False)
speed	joint speed (the default unit is ° / s): Unit: if is_radian = True, the unit is rad / s; if is_radian = False, the unit is ° / s;
mvacc	joint acceleration (default unit is ° / s ²) Unit: if is_radian = True, the unit is rad / s ² ; if is_radian = False, the unit is ° / s ² ;
is_radian	roll / pitch / yaw Whether it is measured in radian (default is_radian = False) If is_radian = True, the unit of roll / pitch / yaw is radian; If is_radian = False, the unit of roll / pitch / yaw is degree (°);
wait	If wait = True, wait for the current commands to finish before sending the next commands; If wait = False, send the next commands directly;
mvtime	0,reserved;

Note:

1. If the joint angle is to be set in radian, then is_radian = True;

ex: code = arm.set_servo_angle (servo_id = 1, angle = 1.57, is_radian = True)

2. To wait for the robotic arm to complete the current commands before returning, wait = True;

ex: code = arm.set_servo_angle (servo_id = 1, angle = 45, is_radian = False, wait = True)

Continuous Joint Motion

Inserting an arc transition between two joint motion commands is a way to plan the continuous joint motion of the robotic arm.

Blockly:

```
set joint speed: 35 %/s
set joint acceleration: 500 %/s2
repeat 10 times
do
  move joint J1 0 J2 14 J3 -25 J4 0 J5 12.9 J6 0 Radius 60 Wait false
  move joint J1 -14 J2 40 J3 -75 J4 0 J5 33.4 J6 -13.8 Radius 60 Wait false
  move joint J1 21.9 J2 44 J3 -80 J4 0 J5 37 J6 29 Radius 60 Wait false
```

The motion trajectory of the robotic arm in the above example is as follows:

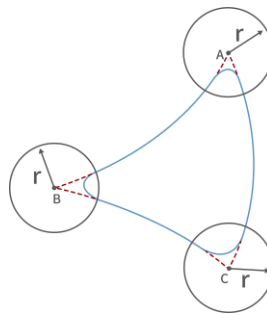

Key parameter description

Radius = 60

Radius =60 in the "move joint" command refers to setting the radius of the transition arc $R = 60\text{mm}$, which is used to achieve a smooth transition of the arc in a joint motion.

The parameters of Radius can be set as Radius > 0, Radius = 0,

Radius = -1, different parameters correspond to different trajectories.

(1) Radius > 0. For example, setting Radius = 60, the turning trajectory is as shown in the arc in the figure below, which can achieve a smooth

turning effect.

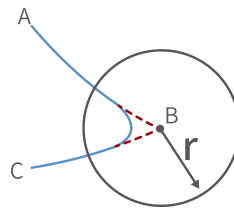

Note: The radius of the arc is smaller than D_{AB} and D_{BC} .

(2) Radius = 0. There is no arc transition at the turn, it will be a sharp turn with no deceleration, as shown in the figure below.

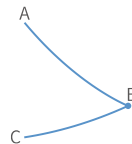

(3) Radius < 0. There is no arc transition at the turn, this speed will not be continuous between this and next motion, as shown in the figure below, speed will decelerate to 0 at point B before moving to C.

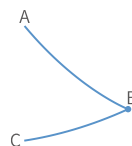

Note: Radius < 0 cannot realize continuous motion. If you need to plan a continuous motion of the robotic arm, please make sure Radius > 0.

Wait = false

The wait in the "move joint" command indicates whether it is necessary to wait for the execution of this command before sending the next command.

Note: If you need to plan for speed continuous motion, make sure wait = false, to buffer the commands to be blended.

2.2.2. Linear Motion and Arc Linear Motion

2.2.2.1. Linear Motion

Characteristics of Linear Motion

The concept of linear motion

- Straight linear motion between Cartesian coordinates (unit: mm), the speed is not continuous between each command.
- Users can control the motion of the robotic arm based on the base coordinate system and TCP coordinate system. The trajectory of tool center point in the Cartesian space is a straight line. Each joint performs a more complex movement to keep the tool in a straight path. The TCP path is unique once the target point is confirmed, and the corresponding posture in the execution process is random. X, Y, and Z control the position of TCP in base or tool coordinate system, in the unit of mm. While Roll/Pitch/Yaw controls the TCP orientation in the unit of degree.
- Linear motion and circular linear motion belong to the Cartesian space trajectory planning, which needs to be solved by inverse

kinematics. Therefore, there may be no solution, multiple solutions, and approximated solutions; and due to the nonlinear relationship between the joint space and Cartesian space, the joint motion may exceed its maximum speed and acceleration limits.

Blockly example:



【Set TCP speed () mm/s】 : Set the speed of the linear motion in mm/s.

【Set TCP acceleration () mm/s²】 : Set the acceleration of the linear motion in mm/s².

【move(arc) line X() Y()Z() Roll() Pitch() Yaw() Radius() Wait(true/false)

【move】 【edit】 】 : Indicates the Cartesian coordinate value of the linear motion and the TCP rotation angle in mm and °.

Note: Cartesian motion is TCP straight-line motion.

Python example:

```
arm.set_tcp_jerk(2000)

arm.set_position(x=205.0, y=100.0, z=110.4, roll=180.0, pitch=0.5, yaw=0.0, speed=100,
radius=-1.0, wait=True)
```

```

arm.set_position(x=205.0, y=120.0, z=110.4, roll=180.0, pitch=0.5, yaw=0.0, speed=100,
radius=-1.0, wait=True)

arm.set_position(x=205.0, y=140.0, z=110.4, roll=180.0, pitch=0.5, yaw=0.0, speed=100,
radius=-1.0, wait=True)

arm.reset()

```

The interface `set_position()` is described in Table 2.2:

Table 2.2 `set_position` description

set_position		
Description	Sets the Cartesian coordinate value of the linear motion	
Parameter	x	coordinate x, (unit: mm)
	y	coordinate y, (unit: mm)
	z	coordinate z, (unit: mm)
	roll	attitude roll (default unit is °) : Unit: if <code>is_radian = True</code> , the unit is rad; if <code>is_radian = False</code> , the unit is °;
	pitch	attitude pitch (default unit is °): Unit: if <code>is_radian = True</code> , the unit is rad; if <code>is_radian = False</code> , the unit is °;
	yaw	attitude yaw (default unit is °): Unit: if <code>is_radian = True</code> , the unit is rad; if <code>is_radian = False</code> , the unit is °;
	radius	radius: if it is a linear motion, <code>radius < 0</code> / <code>radius = None</code> ; if it is arc linear motion(blended), <code>radius > 0</code> ;
	is_radian	if <code>is_radian = True</code> , the unit of roll / pitch / yaw is rad; if <code>is_radian = False</code> , the unit of roll / pitch / yaw is °;
	speed	TCP motion speed (mm / s, rad / s);
	mvacc	TCP motion acceleration (mm / s ² , rad / s ²);
	mvtime	0, reserved;
	relative	if <code>relative = True</code> , it is relative motion; if <code>relative = False</code> , it is not relative motion;

	wait	<p>if wait = True, wait for the current commands to finish before sending the next commands;</p> <p>if wait = False, send the next commands directly;</p>
--	------	---

Note: If it is xArm5, roll and pitch must be set to roll = $\pm 180^\circ$ and pitch = 0° .

2.2.2.2. Arc Linear Motion

Characteristics of Arc Linear Motion:

Arc linear motion (Lineb), inserting arc transitions between two straight lines, is a way to plan the continuous movement of the robotic arm. The following figure is a simple example of continuous motion using a circular arc linear motion planning robotic arm.

Note: When the xArm firmware version $\geq 1.6.0$, if you need to plan Lineb motion, you need to adjust the TCP speed below 200mm/s for debugging, otherwise there will be a high security risk.

Blockly:

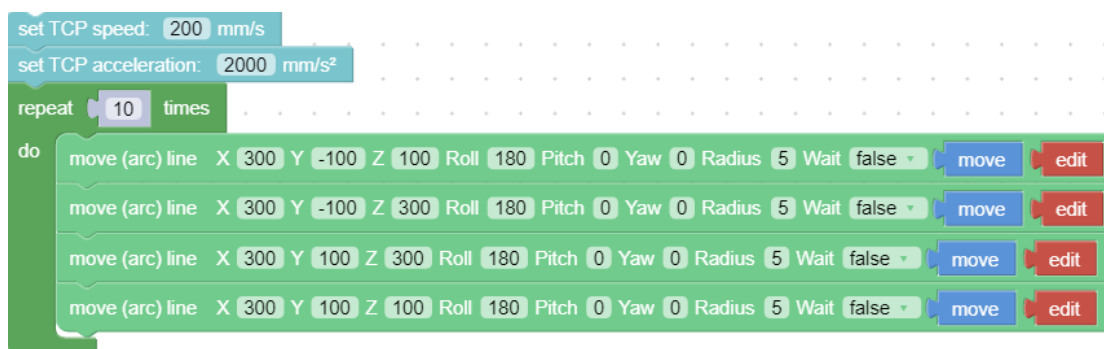

Key parameter description

Radius = 5

Radius = 5 in the "move (arc) line" command refers to setting the radius of the transition arc between two straight lines $R = 5\text{mm}$, which is used to achieve a smooth transition of the arc in a straight motion.

The parameters of Radius can be set as Radius > 0, Radius = 0, Radius = -1, different parameters correspond to different trajectories.

(4) Radius > 0. For example, setting Radius = 5, the turning trajectory is as shown in the black arc in the figure below, which can achieve a smooth turning effect.

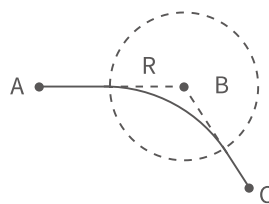

Note: The radius of the arc is smaller than D_{AB} and D_{BC} .

(5) Radius = 0. There is no arc transition at the turn, it will be a sharp turn with no deceleration, as shown in the figure below.

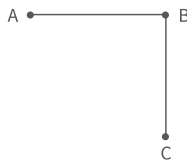

Note: If the motion of the robotic arm is a reciprocating linear motion, you need to set radius=0. If the radius > 0, the robotic arm may report a motion planning error.

(6) Radius < 0 . There is no arc transition at the turn, this speed will not be continuous between this and next motion, as shown in the figure below, speed will decelerate to 0 at point B before moving to C.

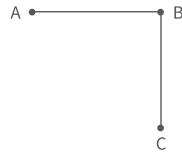

Note: Radius < 0 cannot realize continuous motion. If you need to plan a continuous movement of the robotic arm, please make sure Radius ≥ 0 .

Wait = false

The wait in the "move (arc) line" command indicates whether it is necessary to wait for the execution of this command before sending the next command.

Note: If you need to plan for speed continuous motion, make sure wait = false, to buffer the commands to be blended.

Python example:

```
arm.reset(wait=True)
arm.set_pause_time(0.5)

while True:
    arm.set_position(x=400, y=-100, z=250, roll=180, pitch=0, yaw=0, radius=50, speed=200,
wait=False)
    arm.set_position(x=400, y=100, z=250, roll=180, pitch=0, yaw=0, radius=50, speed=200,
wait=False)
```



```
arm.set_position(x=300, y=0, z=250, roll=-180, pitch=0, yaw=0, radius=50, speed=200,
wait=False)
```

set_position interface: refer to Table 2.2.

The set_pause_time interface is described in Table 2.3:

Table 2.3 set_pause_time description

set_pause_time		
Description	Set the robotic arm pause time	
Parameter	sitime	pause time, unit: second (s);
	wait	whether to wait, default is False;

2.2.3. Circular and Arc Motion

The circular motion calculates the trajectory of the spatial circle according to the coordinates of three points, which are (starting point, pose 1, pose 2).

The calculation method of three-point drawing circle:

Use the current point as the starting point, and then set two position points. Three points define a circle. Make sure these three points are not in a common line.

Set the center angle:

1. If $0 < \text{center angle } (^{\circ}) < 360^{\circ}$ or $\text{center angle } (^{\circ}) > 360^{\circ}$, the motion path of the robotic arm is a circular arc of the corresponding degree;

center angle = 60°, the motion trajectory of the robotic arm is:

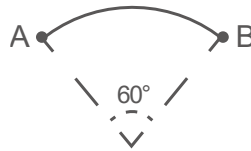

2. The center angle ($^{\circ}$) = 360° , the movement track of the robotic arm is a complete circle;

3. If you want to draw multiple circles continuously (for example, draw 10 circles continuously), set center angles equal to 3600° ;

Blockly example:

```

remark Draw Circle
set TCP acceleration: 2000 mm/s²
set TCP speed: 300 mm/s
repeat 10 times
do
  move joint J1 0 J2 -45 J3 0 J4 0 J5 -45 J6 0 Wait true
  move (arc) line X 300 Y 0 Z 400 Roll 0 Pitch -90 Yaw 180 Radius -1 Wait true
  move circle
  Pose1 cartesian X 350 Y 50 Z 400 Roll 180 Pitch -90 Yaw 0
  Pose2 cartesian X 350 Y -50 Z 400 Roll 180 Pitch -90 Yaw 0
  Center angle(°) 3600
  Wait true

```

【move circle position 1 to position 2】 : From current position, the whole circle is determined by current position and position1 and position2, “center angle” specifies how much of the circle to execute.

Note: (1) The starting point, pose 1 and pose 2 determine the three reference points of a complete circle. If the motion path of the robotic arm is a circular arc, then pose 1 and pose 2 are not necessarily end points or passing points;

(2) If you want the robot arm to change its posture during the movement, set the roll, pitch, and yaw of pose 2 to the desired posture when completing the trajectory;

【center angle (°) ()】 : Indicates the degree of the circle. When it is set to 360, a whole circle can be completed, and it can be greater than or less than 360;

Note: To achieve smooth motion, you need to set Wait = false.

Example explanation:

In this example, the central angle is set to 3600° , which means that the robotic arm can draw ten circles at a time, and the robotic arm still stays at the starting point after drawing a circle.

Judgment of the direction of the robotic arm motion

In the above example, the starting point, pose 1 and pose 2 are:

A (300,0,400,180,0,0) B (350,50,400,180,0,0) C (350,-50,400,180,0,0)

- The robotic arm draws a circle in a clockwise direction, and The trajectory of the robotic arm is as follows:

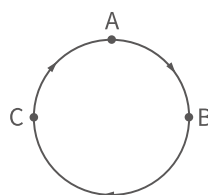

- If the positions of point B and C are swapped, point B is (350,-50,400,180,0,0), point C is (350,50,400,180,0,0), the robotic arm will draw a circle in a counterclockwise direction. The trajectory of the robotic arm is as follows:

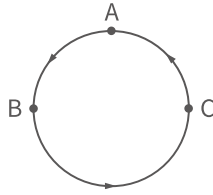

Python example:

```

arm.set_servo_angle(angle=[0.0, -45.0, 0.0, 0.0, -45.0, 0.0], speed=20, mvacc=500, wait=True)
arm.set_position(*[300.0, 0.0, 400.0, 0.0, -90.0, 180.0], speed=300, mvacc=2000, radius=-1.0,
wait=True)
move_circle([350.0, 50.0, 400.0, 180.0, -90.0, 0.0], [350.0, -50.0, 400.0, 180.0, -90.0, 0.0], 1000.0,
speed=300, mvacc=2000, wait=True)

```

set_servo_angle interface: see Table 2.1.

set_position interface: see Table 2.2.

The move_circle interface is described in Table 2.4:

Table 2.4 move_circle description

move_circle		
Description	This motion calculates the trajectory of a space circle based on three-point coordinates. The three-point coordinates are (current starting point, pose 1, pose 2)	
Parameter	pose1	Cartesian coordinates [x(mm), y(mm), z(mm), roll(rad or °), pitch(rad or °), yaw(rad or °)];
	pose2	Cartesian coordinates [x(mm), y(mm), z(mm), roll(rad or °), pitch(rad or °), yaw(rad or °)];
	percent	Percentage of arc moved
	is_radian	If is_radian = True, the unit of roll / pitch / yaw is rad; If is_radian = False, the unit of roll / pitch / yaw is °;
	speed	TCP motion speed (mm / s, rad / s);
	mvacc	TCP motion acceleration (mm / s ² , rad / s ²);
	mvtime	0, reserved;

	wait	<p>If wait = True, wait for the current commands to be sent before sending the next commands;</p> <p>If wait = False, send the next commands directly;</p>
--	------	--

2.3. xArm5 Motion Characteristics

- Cartesian space

The movement of xArm5 is relatively special. Due to the structural limitation, the actual flexible degrees of freedom of linear and circular motions in Cartesian space is 4, which is $[x, y, z, \text{yaw}]$, similar to a SCARA manipulator with four degrees of freedom.

Before starting Cartesian control, it is necessary to ensure that the end flange surface of xArm5 and the base are completely parallel.

If mounted on horizontal plane, the roll and pitch should be $[\pm 180 \text{ degrees}, 0 \text{ degrees}]$, otherwise the trajectory is likely to have no solution.

- Joint space

In joint space, the robotic arm has 5 degrees of freedom to control and can switch to joint commands when different orientations are required at the end. Then use the joint command again to return the flange and the base to a horizontal attitude, and you can switch back to Cartesian control. A quick way to set a cartesian

controllable attitude is: Just set the angle of J4 equal to $-(J2 \text{ angle} + J3 \text{ angle})$.

2.4. Singularity

1. Concept

Singularities occur when the axes of any two joints of a robotic arm are on the same straight line. At the singularity point, the robot's degrees of freedom will be degraded, which will cause the angular velocity of some joints to be too fast, leading to loss of control. A common situation is that when the wrist joint (the penultimate one) is at or near the axis of the first joint, singularity point will also appear (see Figure 2.1), so the robotic arm should try to avoid passing directly the central area near the base, which is likely to cause 1st Joint speed too high.



Figure 2.1 xArm6 singularity

2.Characteristics

The characteristic of the singularity is that the planning movement cannot be performed correctly. Coordinate-based planned movements cannot be explicitly translated into joint motions of each axis. When the robot performs motion planning (linear, circular, etc., excluding joint movements) near the singularity point, it will stop to avoid high instantaneous speed of the joint when it passes the singularity point. Therefore, try to avoid the singularity point or pass the singularity point through joint motion.

3.Processing method for singularity point

Case 1: Singularity encountered during robot teaching

- a) Switch the robot coordinate system to a joint coordinate

system, and pass the singularity point through joint motion.

Case 2: Singularities encountered while the program is running

- a) When encountering a singularity point while running the program, you can modify the position and attitude of the robot and re-plan the path to the target point.

Note:

It is important to consider the cylindrical volume directly above and directly below the base of the robotic arm when a mounting place for the robotic arm is chosen. Moving the wrist joint(second last joint) close to the cylindrical volume should be avoided if possible, because it causes the joints to move fast even though the robotic arm is moving slowly, causing the robot to work inefficiently and making it difficult to conduct a risk assessment.

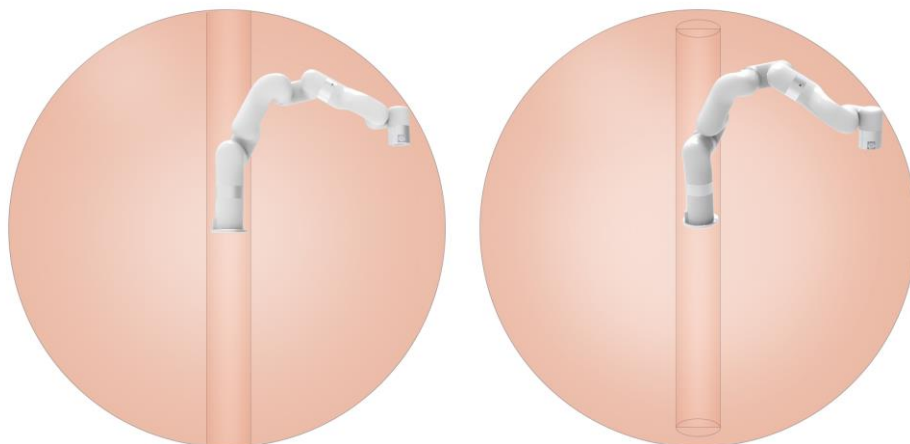

3. Typical Examples

3.1. The Use of xArm Vacuum Gripper

The download address of the Blockly program:

[The use of xArm vacuum gripper.blockly](#)

```
set TCP speed: 200 mm/s
set TCP acceleration: 20000 mm/s²
set joint speed: 20 °/s
set joint acceleration: 500 °/s²
move (arc) line X 425.9 Y 0 Z 678.8 Roll 180 Pitch 0 Yaw 0 Radius -1 Wait true
move (arc) line X 430.4 Y 0 Z 389.7 Roll 180 Pitch -12 Yaw 0.1 Radius -1 Wait true
set xarm vacuum gripper ON object detection false
if object is picked timeout 3
do
  move joint J1 97.8 J2 -23.9 J3 -93.9 J4 0 J5 116.1 J6 0 Wait true
  move (arc) line X -36.9 Y 344.5 Z 471.8 Roll 180 Pitch -1.7 Yaw 97.8 Radius -1 Wait true
  set xarm vacuum gripper OFF object detection false
  move (arc) line X 425.9 Y 0 Z 678.8 Roll 180 Pitch 0 Yaw 0 Radius -1 Wait true
else
  move joint J1 -81.9 J2 -23.9 J3 -93.9 J4 0 J5 116.1 J6 0 Wait true
```

The role of this program: execute this program to control the vacuum gripper to suck the target object at the specified position, and then place the target object at the target position.

Explanation of main commands:

【object is (picked/release)】

- Detect whether the vacuum gripper has picked (released) the object, if it is detected that the vacuum gripper has picked (released) the object, then jump out of this command and execute the next command. If the timeout period is exceeded, the vacuum gripper has

not yet picked (released) the object, it will also jump out of the command and execute the next command.

【set xarm vacuum gripper (ON/OFF) object detection (true/false) [set]】 :

- Set the vacuum gripper to be on and off.

[object detection] = true: detect whether the object is sucked, if not, it will jump out of the entire program.

[object detection] = false: do not detect whether the object is sucked.

3.2. The Use of xArm Gripper

The download address of the Blockly program:

[The use of xArm gripper.blockly](#)



The role of this program: execute this program to control the gripper to grip the target object at the specified position, and then place the target object at the target position.

3.3. The Use of the Digital IO

The download address of the Blockly program:

[The use of the digital IO.blockly](#)

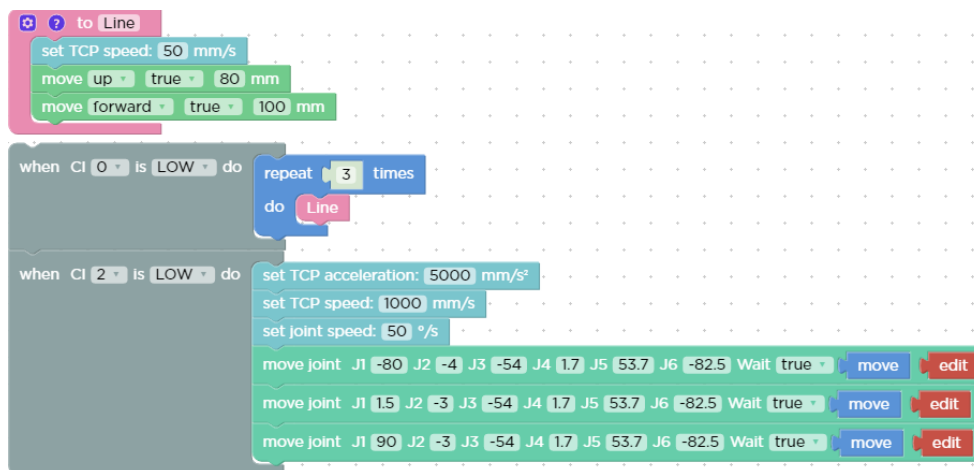

The role of this program: If you need to use digital IO to control the motion of the robotic arm, you can trigger the digital IO to perform the corresponding motion.

Note:

2. The defined function should be placed in front of the main programs, as shown in the figure above.

3.4. Cyclic Motion Count

The download address of the Blockly program: [Cyclic Motion Count.blockly](#)

Counter counts:

```
set TCP speed: 200 mm/s
set TCP acceleration: 3000 mm/s²
sleep 1 s
counter reset
forever
  counter plus
  move (arc) line X 500 Y 0 Z 112 Roll 180 Pitch 0 Yaw 0 Radius 0 Wait true
  move circle
    Pose1 cartesian X 300 Y -100 Z 112 Roll 180 Pitch 0 Yaw 0
    Pose2 cartesian X 300 Y 100 Z 112 Roll 180 Pitch 0 Yaw 0
    Center angle(°) 36000
    Wait true
```

Cyclic motion count: By adding **【Counter plus】**, each time the command is run, the counter of the Control Box will be incremented by 1. It can be used to calculate the number of times the program cycles.

【Counter reset】: This command resets the counter in the Control Box to 0.

Variable ++ i class count:

1. wait = true

```
set TCP speed: 100 mm/s
set TCP acceleration: 2000 mm/s²
set i to 0
repeat 10 times
  do
    change i by 1
    variable printing i
    move (arc) line X 205 Y 100 Z 110.4 Roll 180 Pitch 0.5 Yaw 0 Radius 0 Wait true
    move (arc) line X 205 Y 120 Z 110.4 Roll 180 Pitch 0.5 Yaw 0 Radius 0 Wait true
    move (arc) line X 205 Y 140 Z 110.4 Roll 180 Pitch 0.5 Yaw 0 Radius 0 Wait true
```

When wait = true, the counting effect of the ++ i class and the counter counting are consistent.

2. wait = false

```
set TCP speed: 100 mm/s
set TCP acceleration: 2000 mm/s²
set i to 0
repeat 10 times
do
  change i by 1
  variable printing i
  move (arc) line X 205 Y 100 Z 110.4 Roll 180 Pitch 0.5 Yaw 0 Radius 0 Wait false
  move (arc) line X 205 Y 120 Z 110.4 Roll 180 Pitch 0.5 Yaw 0 Radius 0 Wait false
  move (arc) line X 205 Y 140 Z 110.4 Roll 180 Pitch 0.5 Yaw 0 Radius 0 Wait false
```

When `wait = false`, the `++ i` class count and the count counter are inconsistent. Because `wait = false`, the commands will be sent continuously until the control box buffer is full (According to the above example, the number of cycles of the robotic arm is 10 times. When `wait = false`, the `++ i` class count will take into account all commands already sent to the robotic arm, regardless of whether the robotic arm has completed 10 cycles.), the counter count is a count made by the firmware through position detection, and it is a count of the actual number of cycles of the robotic arm.

Note: If the robotic arm needs to count the cyclic motion, it is recommended to use the counter for counting.

Appendix

Appendix1-Error Reporting and Handling

1.1 Joints Error Message and Error Handling

- Error processing method: Re-power on, the steps are as follows:
 1. Turn the emergency stop button on the control box
 2. Enable the robotic arm
- xArm Studio enable method: Click the guide button of the error pop-up window .
- xArm-Python-SDK enable method: [Refer to Error Handling Mode.](#)
- xArm-ROS-library: Users can view related documents at https://github.com/xArm-Developer/xarm_ros
- If the problem remains unsolved after power on/off for multiple times, please contact UFACTORY team for support.

Software Error Code	Error Handling
S10	Abnormal Current Detection Please restart the xArm with the Emergency Stop Button on the xArm Control Box.
S11	Joint Overcurrent Please restart the xArm with the Emergency Stop Button on the xArm Control Box.
S12	Joint Overspeed Please restart the xArm with the Emergency Stop Button on the xArm Control Box.
S14	Position Command Overlimit Please restart the xArm with the Emergency Stop Button on the xArm Control Box.
S15	Joints Overheat If the robotic arm is running for a long time, please stop running and wait for the joints to cool down.
S16	Encoder Initialization Error Please ensure that there is no external force to push the robotic arm when the it's energized. Please restart the xArm with the Emergency Stop Button on the xArm Control Box.
S17	Single-turn Encoder Error Please re-enable the robot.
S18	Multi-turn Encoder Error Please contact technical support.
S19	Low Battery Voltage Please contact technical support.
S20	Driver IC Hardware Error Please re-enable the robot.
S21	Driver IC Initialization Error Please restart the xArm with the Emergency Stop Button on the xArm Control Box.
S22	Encoder Configuration Error Please contact technical support.
S23	Large Motor Position Deviation Please check whether the xArm movement is blocked, whether the payload exceeds the rated payload of xArm, and whether the acceleration value is too large.
S26	Joint N Positive Overrun Please check if angle value of the joint N is too large.

S27	<p style="text-align: center;">Joint N Negative Overrun</p> <p>Please check if the angle value of joint N is too large, if so, please click Clear Error and manually unlock the joint and rotate the joint to the allowed range of motion.</p>
S28	<p style="text-align: center;">Joint Commands Error</p> <p>The xArm is not enabled, please click Enable Robot.</p>
S33	<p style="text-align: center;">Drive Overloaded</p> <p>Please make sure the payload is within the rated load.</p>
S34	<p style="text-align: center;">Motor Overload</p> <p>Please make sure the payload is within the rated load.</p>
S35	<p style="text-align: center;">Motor Type Error</p> <p>Please restart the xArm with the Emergency Stop Button on the xArm Control Box.</p>
S36	<p style="text-align: center;">Driver Type Error</p> <p>Please restart the xArm with the Emergency Stop Button on the xArm Control Box.</p>
S39	<p style="text-align: center;">Joint Overvoltage</p> <p>Please reduce the acceleration value in the Motion Settings.</p>
S40	<p style="text-align: center;">Joint Undervoltage</p> <p>Please reduce the acceleration value in the Motion Settings. Please check if the control box emergency stop switch is released.</p>
S49	<p style="text-align: center;">EEPROM Read and Write Error</p> <p>Please restart the xArm with the Emergency Stop Button on the xArm Control Box.</p>
S52	<p style="text-align: center;">Initialization of Motor Angle Error</p> <p>Please restart the xArm with the Emergency Stop Button on the xArm Control Box.</p>
<p>For alarm codes that are not listed in the above table: Power on again. If the problem remains unsolved after power on/off for multiple times, please contact technical support.</p>	

1.2 Control Box Error Code and Error Handling

1.2.1 Control Box Error Code

If there is an error in the hardware of the robotic arm/the software of the Control Box/in sending commands, an error or warning will be issued. This error/warning signal will be fed back when the user sends any command; that is, the feedback is passive and not actively reported.

After the above error occurs, the robotic arm will stop working immediately and discard the Control Box cache command. Users need to clear these errors manually to allow normal operation. Please re-adjust the motion planning of the robotic arm according to the reported error message.

Software Error	Error Handling
C1	The Emergency Stop Button on the Control Box is Pushed in to Stop please release the Emergency Stop Button, and then click "Enable Robot"
C11-C17	Power on gain.
C19	Gripper Communication Error Please check if the Gripper is installed or the baud rate setting is correct, or restart the xArm with the Emergency Stop Button on the xArm Control Box.
C21	Kinematic Error Please re-plan the path.
C22	Self-collision Error, Please Re-plan the Path. If the robotic arm continues to report self-collision errors, please go to the "live control" interface to turn on the "manual mode" and drag the robotic arm back to the normal position.
C23	Joints Angle Exceed Limit

	Please click the "ZERO" button to return to the zero position.
C24	Speed Exceeds Limit Please check if the xArm is at singularity point, or reduce the speed and acceleration values.
C25	Planning Error Please re-plan the path or reduce the speed.
C26	Linux RT Error Please contact technical support.
C27	Command Reply Error Please retry, or restart the xArm with the Emergency Stop Button on the xArm Control Box.
C28	End Module Communication Error Please restart the xArm with the Emergency Stop Button on the xArm Control Box.
C29	Other Errors Please contact technical support.
C30	Feedback Speed Exceeds Limit Please contact technical support.
C31	Collision Caused Abnormal Current Please check for collisions, check that the payload settings are correct, and that the collision sensitivity matches the speed.
C32	Three-point Drawing Circle Calculation Error please reset the arc command.
C33	Control Box GPIO Error If the error occurs repeatedly, please contact technical support.
C34	Recording Timeout The track recording duration exceeds the maximum duration limit of 5 minutes. It is recommended to re-record.
C35	Safety Boundary Limit The xArm reaches the safety boundary. Please let the xArm work within the safety boundary.
C36	The Number of Delay Commands Exceeds the Limit The number of delay IO commands or position detection IO commands to be executed cannot exceed 36, please check whether there are too many

C37	Abnormal Motion in Manual Mode Please check whether the TCP payload setting of the robotic arm and the installation method of the robotic arm match the actual settings.
For alarm codes that are not listed in the above table: Power on again. If the problem remains unsolved after power on/off for multiple times, please contact technical support.	

1.2.2 Control Box Error Code

The error does not affect the normal operation of the robotic arm, but it may affect the user's program operation. Once the warning occurs, the arm will set the warning flag and return it together in the command reply. Otherwise, no other operations will be performed. The robotic arm will still operate normally.

Error code	Description	Error Handling
11	Buffer overflow	Control the volume of command
12	Command parameter abnormal	Check sent command
13	Unknown Command	Check sent command
14	Command no solution	Check sent command

1.3 Gripper Error Code & Error Handling

The user can re-power on the robotic arm as an error handling, the steps are as follows (all the following steps are needed):

1. Re-powering the robotic arm via the emergency stop button on the control box.
2. Enable the robotic arm.

a. xArm Studio enable method: Click the guide button of the error pop-up window or the 'STOP' red button in the upper right corner.

b. xArm-Python-SDK enable method: Refer to Error Handling Method.

c. xArm_ros library: users can view related documents at https://github.com/xArm-Developer/xarm_ros

3. Re-enable the gripper.

If the problem remains unsolved after power on/off multiple times, please contact UFACTORY team for support.

Software Error	Error Handling
G9	Gripper Current Detection Error Please restart the xArm with the Emergency Stop Button on the xArm Control Box.
G11	Gripper Current Overlimit Please click "OK" to re-enable the Gripper.
G12	Gripper Speed Overlimit Please click "OK" to re-enable the Gripper.
G14	Gripper Position Command Overlimit Please click "OK" to re-enable the Gripper.
G15	Gripper EEPROM Read and Write Error Please click "OK" to re-enable the Gripper.
G20	Gripper Driver IC Hardware Error Please click "OK" to re-enable the Gripper.
G21	Gripper Driver IC Initialization Error Please click "OK" to re-enable the Gripper.

G23	Gripper Large Motor Position Deviation Please check if the movement of the Gripper is blocked, if not, please click "OK" to re-enable the Gripper.
G25	Gripper Command Over Software Limit Please check if the gripper command is set beyond the software limit.
G26	Gripper Feedback Position Software Limit Please contact technical support.
G33	Gripper Drive Overloaded Please contact technical support.
G34	Gripper Motor Overload Please contact technical support.
G36	Gripper Driver Type Error Please click "OK" to re-enable the Gripper.
For alarm codes that are not listed in the above table: enable the robotic arm and gripper. If the problem remains unsolved after power on/off for multiple times, please contact technical support.	

1.4 Python SDK Error Code & Error Handling

Software Error	Error Handling
A-9	Emergency Stop
A-8	The TCP position command is out of the robot arm's motion range. Please adjust the TCP position command.
A-2	xArm is not ready. Please check whether the robot is enabled and the state is set correctly.
A-1	xArm is disconnect or not connect. Please check the network.
A1	There are errors that have not been cleared. Please clear the errors and try again.
A2	There are warnings that have not been cleared. Please clear the warnings and try again.
A3	Get response timeout. Please check the firmware version and the network.

A4	TCP reply length error. Please check the network.
A5	TCP reply number error. Please check the network.
A6	TCP protocol flag error. Please check the network.
A7	The TCP reply command does not match the sending command. Please check the network.
A8	Send command error. Please check the network.
A9	xArm is not ready. Please check whether the errors have been cleared, whether the robot arm has been enabled, and whether the robot arm status is set correctly.
A11	Other error. Please contact technical support.
A12	Parameter error.
A20	Tool IO ID error.
A22	The end tool Modbus baud rate is incorrect.
A23	The end tool Modbus reply length error.
A31	Trajectory read/write failed.
A32	Trajectory read/write timeout.
A33	Playback trajectory timeout.
A41	Vacuum gripper wait timeout.
A100	Waiting for completion timeout.
A101	Too many failures to detect the status of the end effector.
A102	There are errors in the end effector
A103	The end effector is not enabled
For alarm codes that are not listed in the above table: enable the robotic arm and gripper. If the problem remains unsolved after power on/off for multiple times, please contact technical support.	

xArm-Python-SDK Error Handling:

When designing the robotic arm motion path with the Python library, if the robotic arm error (see Appendix for Alarm information) occurs, then

it needs to be cleared manually. After clearing the error, the robotic arm should be motion enabled.

Python library error clearing steps: (Please check GitHub for details on the following interfaces)

- a. error clearing: `clean_error()`
- b. Re-enable the robotic arm: `motion_enable(true)`
- c. Set the motion state: `set_state(0)`

Appendix2-Technical Specifications

2.1 xArm5/6/7 Common Specifications

xArm		
Cartesian Range	X	±700mm
	Y	±700mm
	Z	-400mm~951.5mm
	Roll/Yaw/Pitch	± 180°
Maximum Joint Speed		180°/s
Reach		700mm
Repeatability		±0.1mm
Max Speed of End-effector		1m/s
Ambient Temperature Range		0-50 °C
Power Consumption		Min 8.4 W, Typical 200W, Max 400W
Input Power Supply		24 V DC, 16.5 A
ISO Class Cleanroom		5
Robotic Arm Mounting		Any
Programming		xArm Studio/Python/C++/ROS
Robotic Arm Communication Protocol		Modbus-TCP
End-effector I/O Interface		2 Digital inputs, 2 Digital outputs, 2 Analog inputs
End-effector Communication Protocol		Modbus-RTU
Footprint		Ø 126 mm
Materials		Aluminium, Carbon Fiber
End Tool Flange		DIN ISO 9409-1-A50/63 (M5*6)
Control Box		
	AC Control Box	DC Control Box
Input	100-240VAC 50/60Hz	24VDC
Output	24VDC 16.5A	
Control Box Communication Protocol	Modbus TCP	
Control Box Communication Model	Ethernet	
Control Box I/O Interface	8*CI(Digital In) 8*CO(Digital Out) 2*AI(Analog In) 2*AO(Analog Out)	
Weight	3.8kg	1.6kg
Dimension(L*W*H)	280*200*116mm	180*145*68mm

xArm accessories parameters:

Gripper	
Nominal Supply Voltage	24V DC
Absolute Maximum Supply Voltage	28V DC
Quiescent Power (Minimum Power)	1.5W
Peak Current	1.5A
Working Range	84mm
Maximum Clamping Force	30N
Weight (g)	802g
Communication Mode	RS-485
Communication Protocol	Modbus RTU
Programmable Gripping Parameters	Position, Speed
Feedback	Position
Vacuum Gripper	
Rated Supply Voltage	24V DC
Absolute Maximum Supply Voltage	28V DC
Quiescent Current(mA)	30mA
Peak Current(mA)	400mA
Vacuum	78%
Vacuum Flow (L/min)	> 5.6L/min
Weight (g)	610 g
Dimensions (L*W*H)	122.5 * 91.6 * 75mm
Payload (kg)	≤5kg
Noise Level (30cm away)	< 60dB
Communication Mode	Digital IO
State Indicator	Power, Working State
Feedback	Air Pressure (Low or Normal)
Notes:	
1. The ambient temperature of xArm is 0-50 °C, please reduce the temperature if continuous high-speed operation is needed.	

2.2 xArm 5 Specifications

Joint Range	1,5	±360°
	2	-118°~120°
	3	-225°~11°
	4	-97°~180°

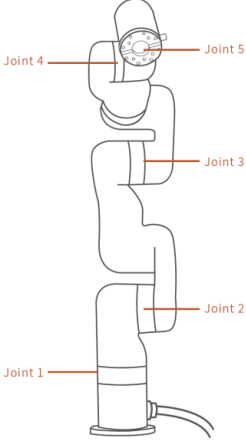
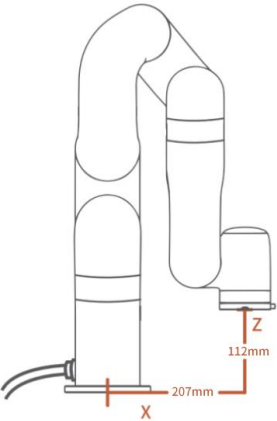
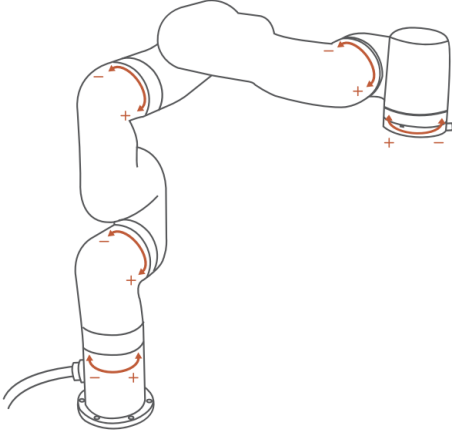
Payload	3kg
Degrees of Freedom	5
Weight(robotic arm only)	11.2kg
 <p>Robot Joints</p>	 <p>Robot Zero Attitude</p>
 <p>Joint Rotating Direction</p>	

2.3 xArm 6 Specifications

Joint Range	1,4,6	$\pm 360^\circ$
	2	$-118^\circ \sim 120^\circ$
	3	$-225^\circ \sim 11^\circ$
	5	$-97^\circ \sim 180^\circ$
Payload		5kg
Degrees of Freedom		6
Repeatability		$\pm 0.1\text{mm}$
Weight(robotic arm only)		12.2kg

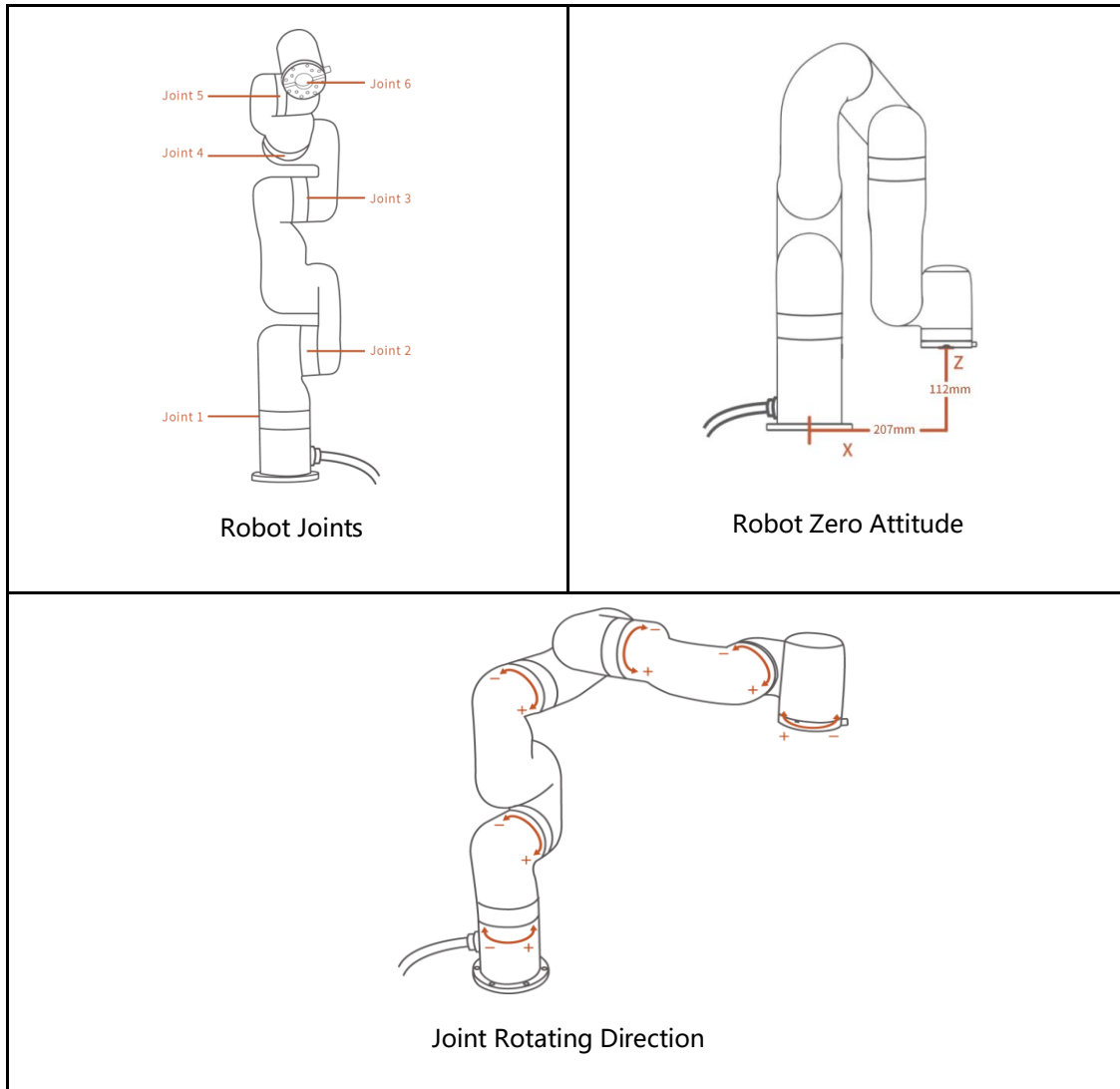

2.4 xArm 7 Specifications

Joint Range	1,3,5,7	$\pm 360^\circ$
	2	$-118^\circ \sim 120^\circ$
	4	$-11^\circ \sim 225^\circ$
	6	$-97^\circ \sim 180^\circ$
Payload		3.5kg
Degrees of Freedom		7
Weight(robotic arm only)		13.7kg

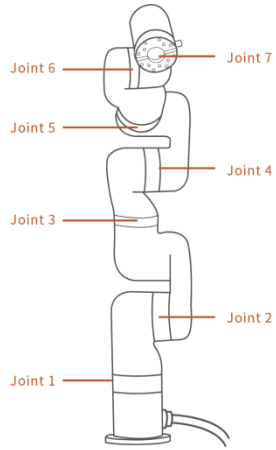

Robot Joints

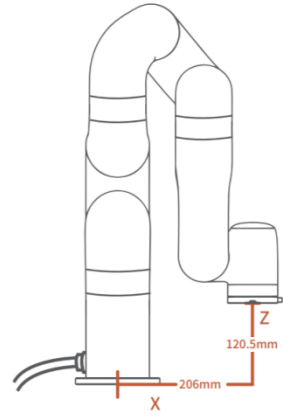

Robot Zero Attitude

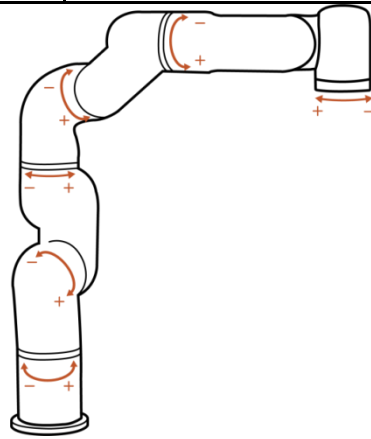

Joint Rotating Direction

Appendix3-FAQ

1. [Guide for xArm Studio displaying "Sever is not ready"](#)
2. [Guide to use the Vacuum Gripper](#)
3. [Guide to download the log file on the xArm Studio](#)
4. [Solve the problem that all joints of the xArm are at '0' in the gazebo](#)
5. [The Method of the IP Configuration](#)
6. [How to use PLC to control xArm](#)
7. [Guide to control xArm by tablet](#)
8. [Kinematic and Dynamic Parameters of xArm Series](#)
9. [The Proper Way to Power DC Control Box](#)
10. [How to get the joint current/torque data of the xArm robot](#)
11. [Guide to Update the xArm Studio and xArm Firmware](#)
12. [What should I do if I have a problem with xArm?](#)
13. [Guide to install the xArm Camera Module](#)
14. [Guide to use the Robotiq Gripper on xArm](#)
15. [Guide to run xArm at the maximum speed](#)

Appendix4-The xArm Software/Firmware

Update Method.

There are five ways of network settings for the robotic arm, you can choose the corresponding update method according to the different methods of the robotic arm network setting.

Notes

1) It is recommended to update the xArm firmware and xArm Studio at the same time.

2) After updating, please download the latest "xArm User Manual" and "xArm Developer Manual" from the official website to learn about the latest features of xArm.

The download link: <https://store-ufactory-cc.myshopify.com/pages/download-xarm>

3) Although the compatibility with the old version of the SDK was fully considered when developing the xArm software, we still recommend:

If you use xArm-Python-SDK (xArm-C++ SDK or xArm ROS), after updating the xArm to the latest firmware, you need to obtain the latest xArm-Python-SDK (xArm-C++ SDK or xArm ROS) from github.

The download link: <https://github.com/xArm-Developer>

1. When you use the following network setting methods, please use xarm-tool-gui tool to update xArm Studio and xArm firmware online.

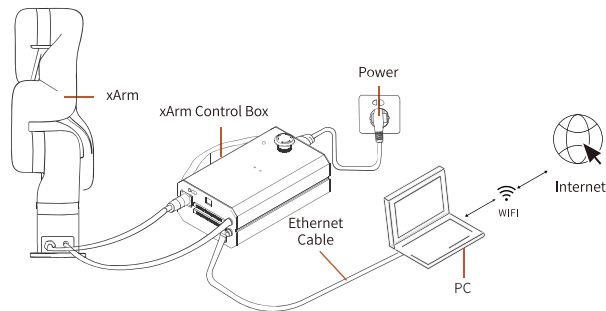

The control box is directly connected to the PC(The PC is connected to the Internet)

• The method for the online update using the xarm-tool-gui tool is as follows:

1) Tool download

Download address of xarm-tool-gui tool, xArm Studio and xArm Firmware installation package:

[xArm-Tool-GUI](#)

Since your PC connected to the xArm control box can access the Internet, you can directly download the above installation package to your PC.

2) After decompressing the installation package, run the xarm-tool-gui program that matches your PC's operating system, select the type of

robotic arm, and enter the IP address of the xArm control box, then click "Connect".

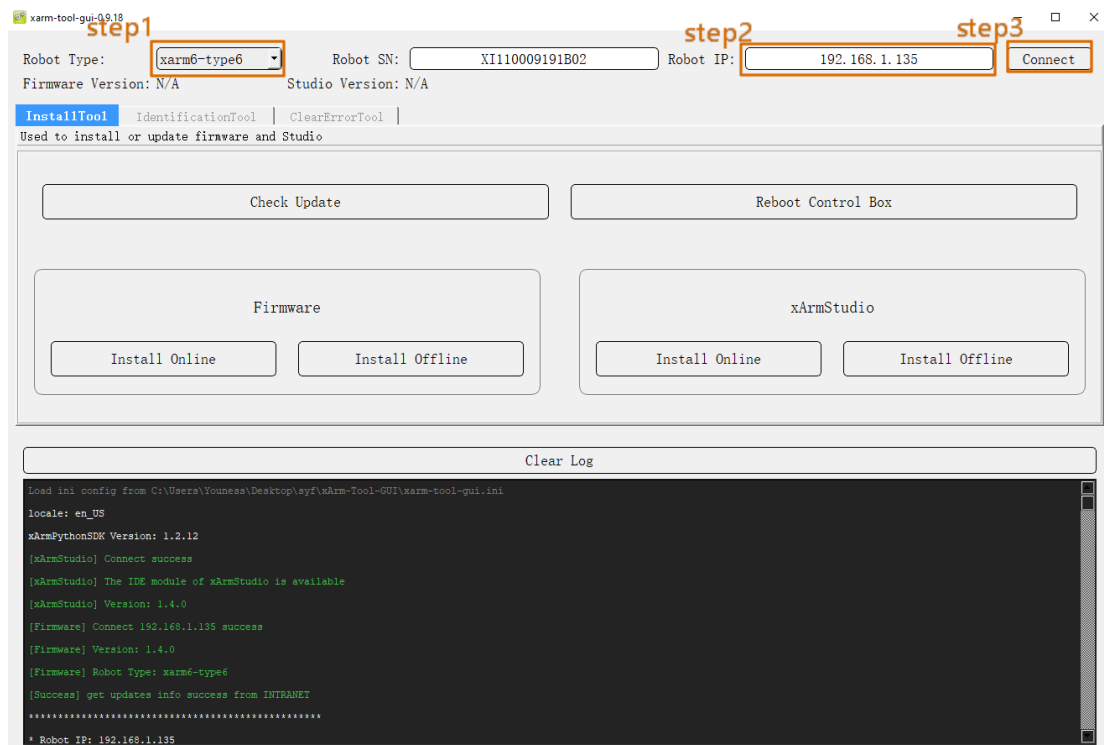

3) After successful connection, click the [Check Update] button, then click the [Install Online] in the Firmware installation box (xArmStudio installation box), and finally click the [Install] button in the pop-up box;

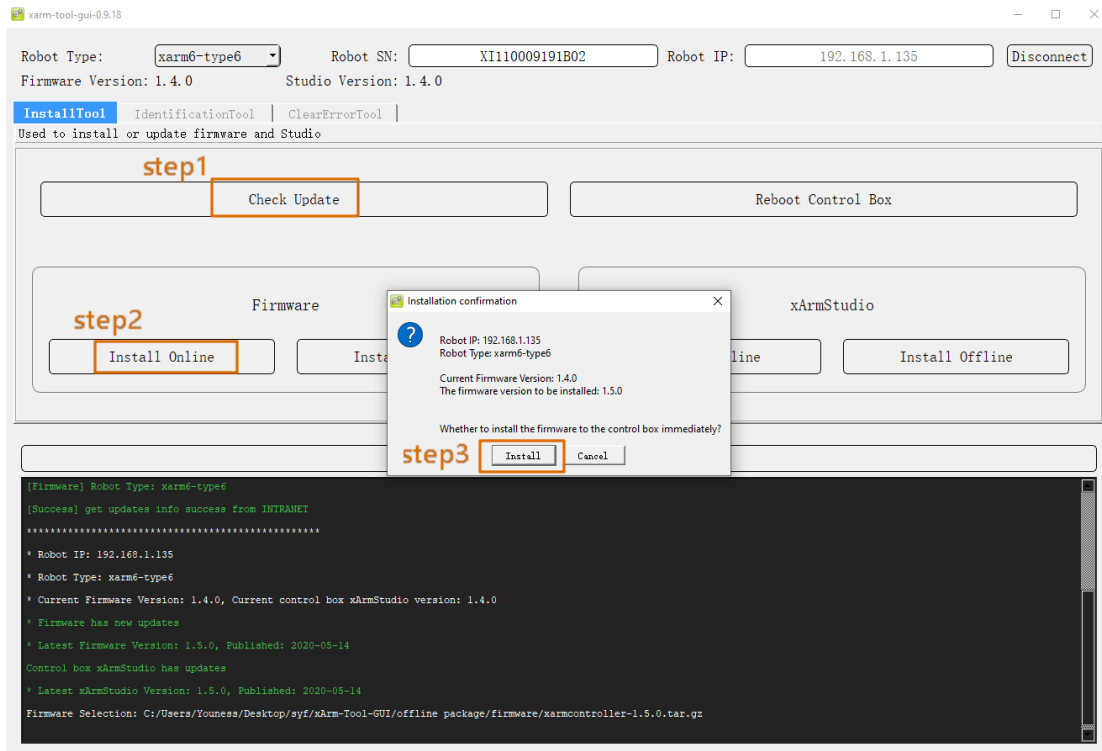

4) After the installation is completed, the console of the xarm-tool-gui will display "Install firmware success" (or "Install Studio success"). Finally, click "Reboot Control Box" and wait for the control box to reboot, the reboot usually takes about 2-3 minutes.

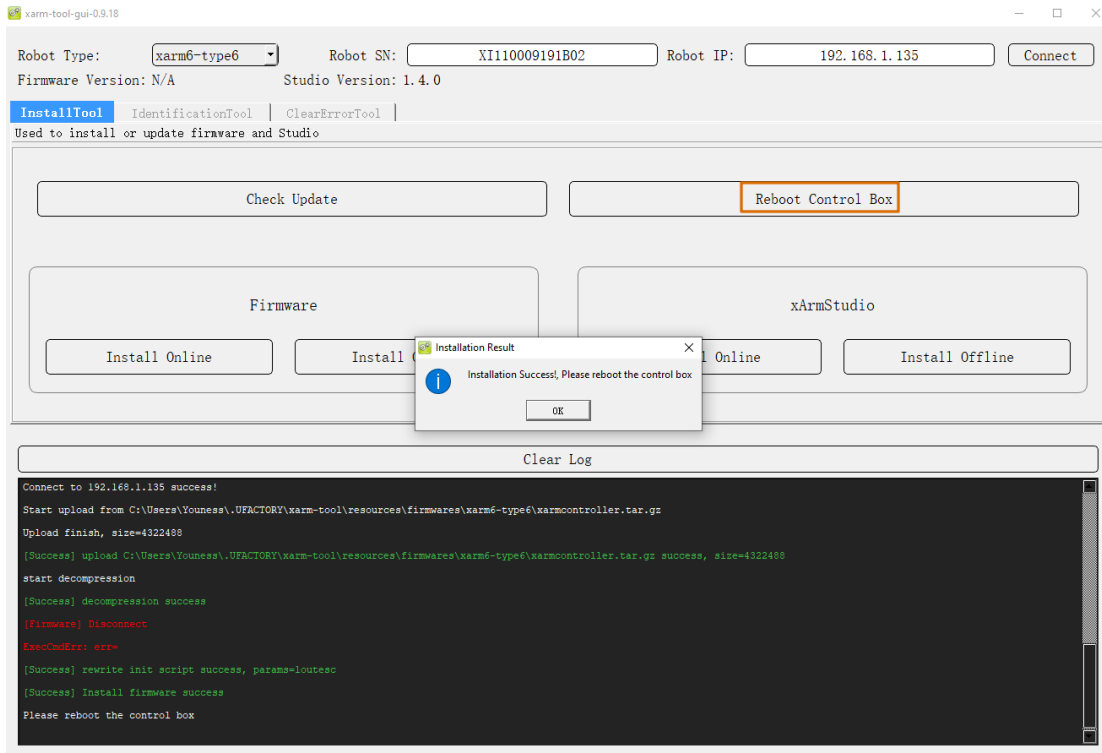

2. When you use the following network setting methods, please use xarm-tool-gui tool to update xArm Studio and xArm firmware offline.

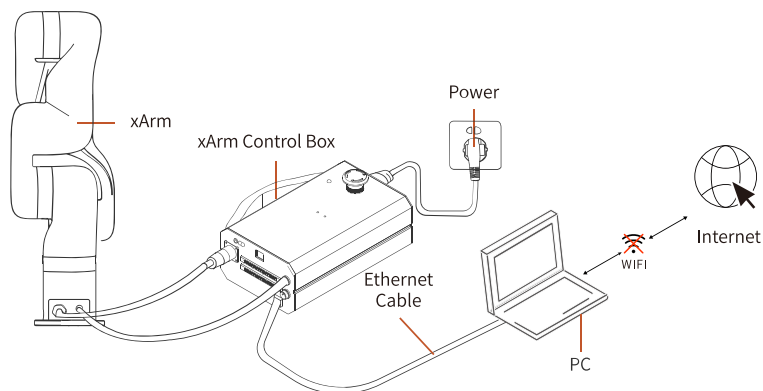

The control box is directly connected to the PC(The PC is not connected to the Internet)

• **The offline update method using the xarm-tool-gui tool is as follows:**

1) Tool download

Download address of xarm-tool-gui tool, xArm Studio, and xArm Firmware installation package:

[xArm-Tool-GUI](#)

Since your PC connected to the xArm control box cannot access the Internet, please download the above installation package using a USB drive, copy it to the PC connected to the xArm control box.

2) After decompressing the installation package, run the xarm-tool-gui program that matches your PC's operating system, select the type of robotic arm, and enter the IP address of the xArm control box, then click "Connect".

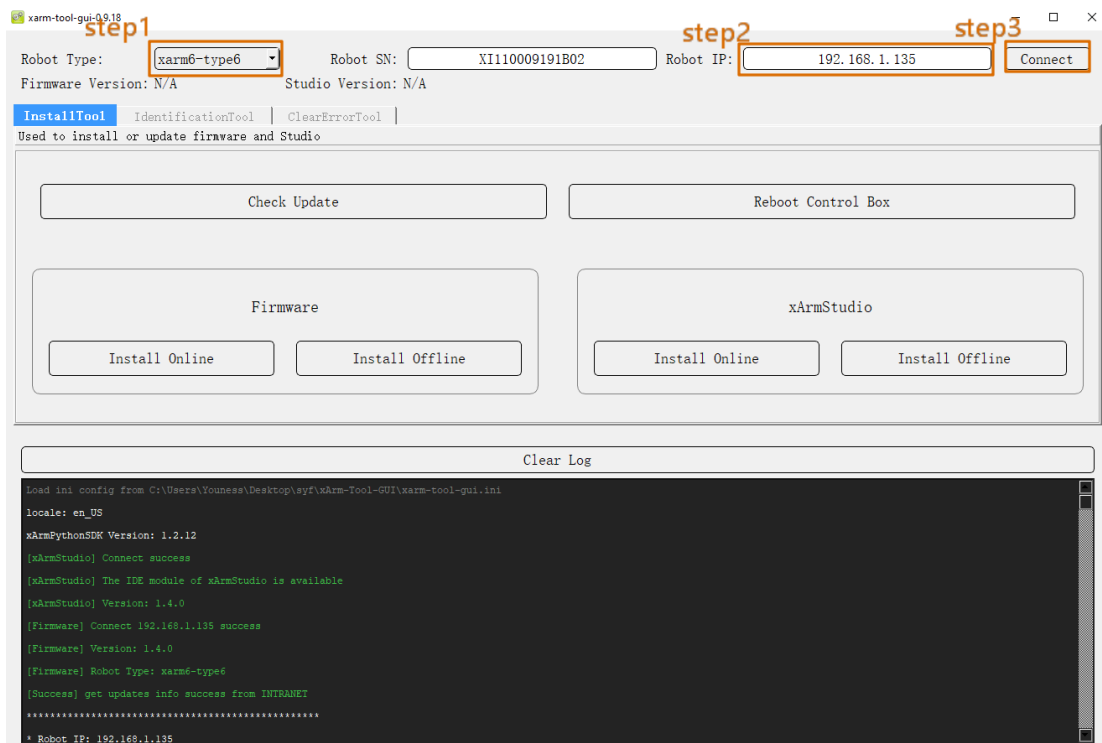

3) After successful connection, click the [Install Offline] in the Firmware installation box (xArmStudio installation box), then load the corresponding "firmware" or "xArm Studio" compressed package in the folder.

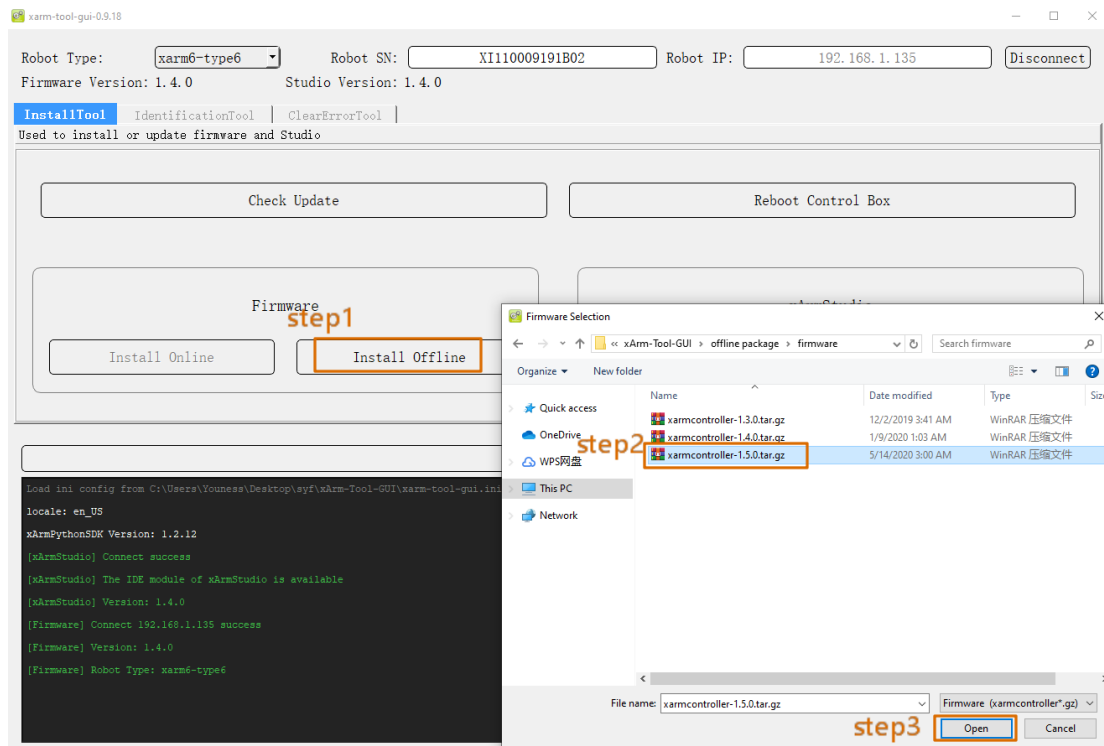

4) Click the [Install] button.

5) After the installation is completed, the console of the xarm-tool-gui will display "Install firmware success" (or "Install Studio success"). Finally, click "Reboot Control Box" and wait for the control box to reboot, the reboot usually takes about 2-3 minutes.

3. When you use the following network setting methods, please use xArm Studio to update the xArm Studio and xArm firmware online.

- **The method of online update using xArm Studio is as follows:**

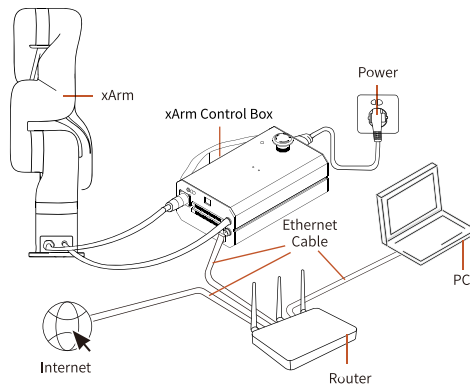

(1) The control box, PC and router are connected by ethernet cable

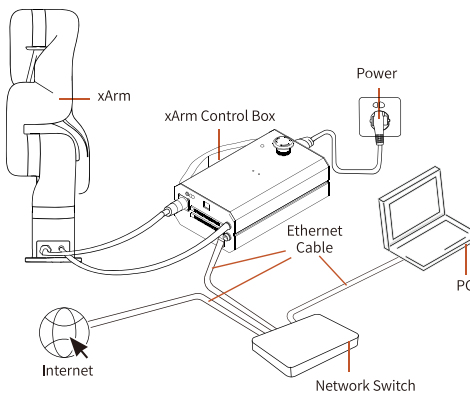

(2) The control box, PC and network switch are connected by ethernet cable

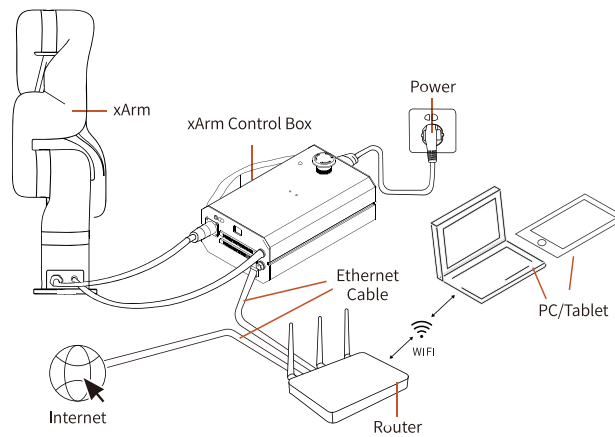

(3) PC and router are connected by wireless network, and control box and router are connected by ethernet cable

Click [Settings] on the xArm Studio homepage, enter [System Settings]
 → [Check Update], click "Update".

Wait for the system to prompt to restart, and then click "Restart", the restart usually takes about 2-3 minutes, please be patient.

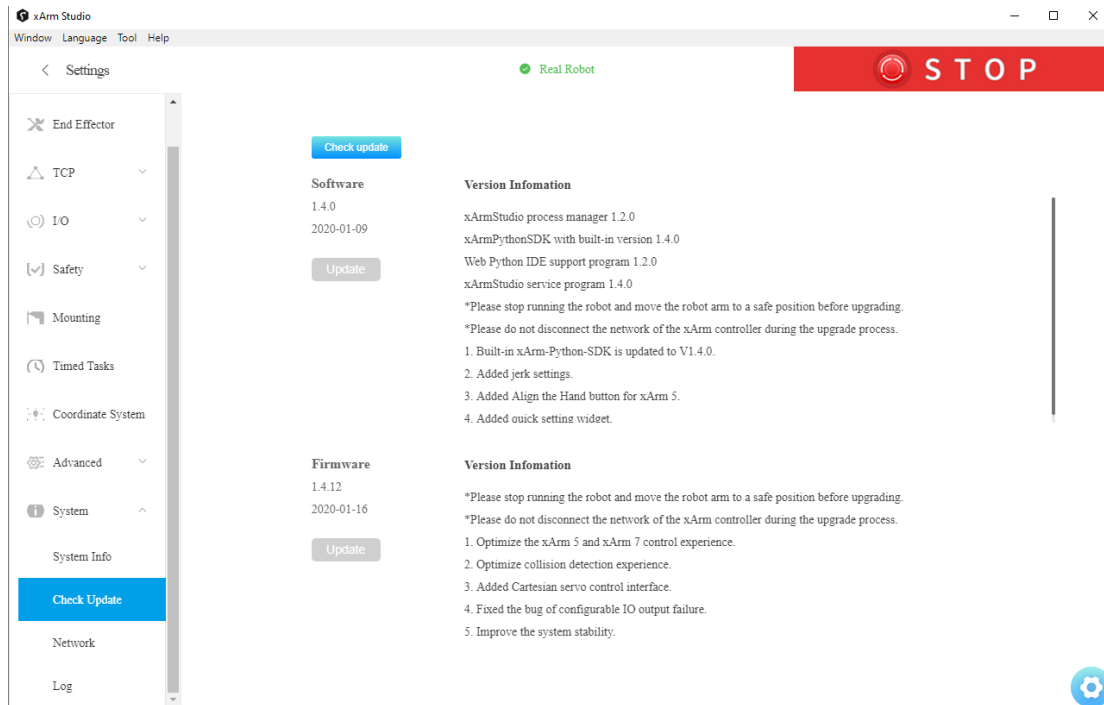

4. Precautions

If there is no IO module on the side of your control box (the IO module is shown in the figure below) and cannot be updated online by xArm Studio, please contact technical support (support@ufactory.cc) to provide a dedicated xarm-tool-gui installation package.

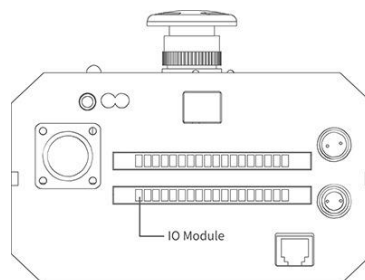

Appendix5- Maintenance and Inspection

1. Long-term placement

If the robotic arm is not used for a long time (≥ 6 months), you need to power on the robotic arm for 6 hours every 6 months to charge the built-in battery of the robotic arm.

When powering on the robotic arm, please release the emergency stop button on the control box, and the robotic arm does not need to be enabled.

2. Clean

After the robotic arm is used for a long time, there may be dirt or grease on the carbon fiber shell (in rare cases, a small amount of grease can be seen at the joints, which will not affect the normal use or life of the joints). You can use 95% alcohol or 70% isopropanol to wipe the carbon fiber surface for cleaning.

Note:

When cleaning the carbon fiber surface, be careful not to let the liquid penetrate the joints.

Appendix6- After-sales Service

1. After-sales policy:

For the detailed after-sales policy of the product, see the official website:

<https://store-ufactory-cc.myshopify.com/pages/warranty-returns>

2. The general process of after-sales service is:

(1) Contact UFACTORY technical support (support@ufactory.cc) to confirm whether the product needs to repair and which part should be sent back to UFACTORY.

(2) After the bill of lading on UPS, we will send the invoice and label to you by mail. You need to make an appointment with the local UPS and then send the product to us.

(3) UFACTORY will check the product warranty status according to the after-sales policy.

(4) Generally, the process takes around 1-2 weeks except for shipment.

Note:

1. Please keep the original packaging materials of the product. When

you need to send the product back to get repaired, please pack the product with the original box to protect the product during the transportation.

2. If you need to send the control box to get repaired, please export and save the configuration file of the robotic arm to prevent the original data from being lost or changed during the repair process(Please refer to the section 1.4.9.2 Advanced Tool-Configuration File).